

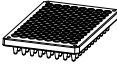

Technical data

Centrifuge 5804/5804 R Centrifuge 5810/5810 R
English (EN)

| Plate | Plate Capacity Plate/ slide per adapter/rotor | Adapter Order no. (international) | Adapter bottom shape Max. loading height | Max. g force Max. speed Centrifugation radius |
|---|--|---|--|--|
|  | PCR plate 96 wells 1/4 |  5825 711.009 | 60 mm | 3486 × g 4500 rpm 154 mm |
| Slide | CombiSlide 8 slides 8/16 |  5825 706.005 | Flat 60 mm | 100 × g 772 rpm 150 mm |

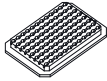





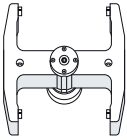
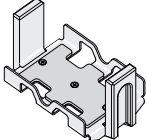

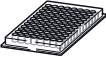
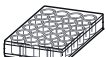
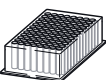
10.6.5 Rotor A-2-DWP

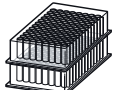

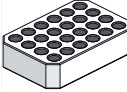
If you are using two fully loaded DWP plates, check the load.

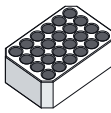
| | | | |
|---|---|--|-----------|
|  |  | Max. g-force: | 2,250 × g |
| Rotor A-2-DWP Swing-bucket rotor with 2 Deepwell plate buckets | Deepwell plate bucket | Max. speed: | 3,700 rpm |
| | | Max. load per bucket (adapter, plate and contents): | 380 g |

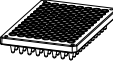
| Plate | Plate Capacity Plates/slides per adapter/rotor | Adapters Order no. (international) | Adapter bottom shape Max. loading height | Max. g-force Max. speed Centrifugation radius |
|---|---|--|---|---|
|  | Micro test plate 96/384 wells 4/8 | SBS adapter* 5825 718.003 | flat 89 mm | 2,250 × g 3,700 rpm 14.7 cm |
|  | Cell culture plate 4/8 | SBS adapter* 5825 718.003 | flat 89 mm | 2,250 × g 3,700 rpm 14.7 cm |
|  | Deepwell plate 96 wells 2/4 | SBS adapter* 5825 718.003 | flat 89 mm | 2,250 × g 3,700 rpm 14.7 cm |

| Plate | Plate Capacity Plates/slides per adapter/rotor | Adapters Order no. (international) | Adapter bottom shape Max. loading height | Max. g-force Max. speed Centrifugation radius |
|---|---|---|---|---|
|  | Kit 1/2 | SBS adapter* 5825 718.003 | flat 89 mm | 2,250 × g 3,700 rpm 14.7 cm |
|  | Tube in IsoRack 24 x 0.5 mL 1/2 |  5825 708.008 | flat Ø 6 mm 89 mm | 2,050 × g 3,700 rpm 13.8 cm |
|  | Tube in IsoRack 24 x 1.5/2 mL 1/2 |  5825 709.004 | flat Ø 11 mm 89 mm | 1,990 × g 3,700 rpm 13.3 cm |
|  | 384-well PCR plate 1/2 |  5825 713.001 | flat 89 mm | 2,170 × g 3,700 rpm 14.2 cm |
|  | 96-well PCR plate 1/2 |  5825 711.009 | flat 89 mm | 2,220 × g 3,700 rpm 14.5 cm |
| Slides | CombiSlide 8 slides 8/16 |  5825 706.005 | flat 60 mm | 100 × g 791 rpm 14.3 cm |

*) Optional. Secures the plate against slipping.