

SINCE 1889



**Instruction Manual
For
MECHANICAL CONVECTION OVENS**

Model

DKN400

DKN600

DKN810

DKN900

Ver.2

Yamato Scientific America, Inc.

Santa Clara, CA

(800)292-6286

Contents

◆ Safety Information	1
• Safety Symbols.....	2
◆ Installation	4
• Installation Requirements	4
◆ Identification of Parts	9
• Main Unit.....	9
• Control Panel.....	12
• Controller Characters.....	13
◆ Operational Procedures	14
• Operation Mode and Function List	14
• Operational Characters.....	16
• Overheat Prevention Device	17
• Fixed Temperature.....	18
• Quick Auto Stop.....	19
• Auto Stop.....	20
• Auto Start.....	22
• Program.....	24
• Other Functions	31
◆ Handling Precautions	32
◆ Maintenance	34
◆ Storage and disposal	35
◆ Troubleshooting	36
◆ Service and Warranty	38
◆ Specifications	39
◆ Wiring Diagram	40
◆ Replacement Parts List	43
◆ Reference	45
• List of Dangerous Substances	45

General Safety Information

MEANING OF ILLUSTRATED SYMBOLS

Illustrated Symbols

Various symbols are used in this safety manual in order to use the unit without danger of injury and damage of the unit. A list of problems caused by ignoring the warnings and improper handling is divided as shown below. Be sure that you understand the warnings and cautions in this manual before operating the unit.

 **WARNING!** If the warning is ignored, there is the danger of a problem that may cause a serious accident or even fatality.

 **CAUTION!** If the caution is ignored, there is the danger of a problem that may cause injury/damage to property or the unit itself.

Meaning of Symbols



This symbol indicates items that urge the warning (including the caution).
A detailed warning message is shown adjacent to the symbol.



This symbol indicates items that are strictly prohibited.
A detailed message is shown adjacent to the symbol with specific actions not to perform.



This symbol indicates items that should be always performed.
A detailed message with instructions is shown adjacent to the symbol.

Safety Symbols

Warning



Warning, general



Warning, high voltage



Warning, high temperature



Warning, drive train



Warning, explosive

Caution



Caution, general



Caution, electrical shock



Caution, scald



Caution, no road heating



Caution, no drenching



Caution, water only



Caution, fatally poisonous

Forbidden



Forbidden, general



Forbidden, inflammable



Forbidden, to disassemble



Forbidden, to touch

Requirements



Requirement, general



Requirement, connect to grounding terminal



Requirement, install on a flat surface

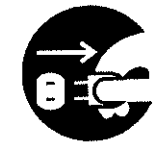

Requirement, disconnect the power plug



Requirement, periodic inspection

Safety Precautions

WARNING!

Do not use this unit in areas where flammable or explosive gasses are present

Never use this unit in areas where flammable or explosive gasses are present. This unit is not explosion-proof. An arc may be generated when the power switch is turned on or off, and can result in a fire and/or explosion. (Refer to page 45 "List of Dangerous Substances".)

Always ground unit

Always ground this unit to avoid electrical shock due to a power surge.

If problems occur

If smoke or strange odors should come out of this unit, turn off the power, circuit breaker, and the main power off respectively. Contact your service technician for inspection immediately. Not following these procedures can result in a fire or electrical shock. Performing repair work yourself is dangerous and strongly discouraged.

Do not bundle the power cord

Do not operate this unit if the power cord is bundled or tangled. Using it in this manner can cause the unit to overheat and result in a fire.

Do not process, bend, or stretch the power cord

Do not process, bend, or stretch the power cord. Fire or electrical shock may result.

Prohibited Substances

Never use explosive or flammable substances and/or substances that include explosive or flammable ingredients. Explosion or fire may result. (Refer to page 45 "List of Dangerous Substances".)

Do not disassemble or modify this unit

Do not disassemble or modify this unit. Not following these instructions may result in fire, electrical shock and/or failure to unit.

Hot surfaces

The interior chamber and door may become hot during and just after operation. Contact with these surfaces may cause burns.

CAUTION!

During a thunderstorm

During a thunderstorm, immediately turn off the power key, circuit breaker, and the main power. Not following these instructions can result in fire or electric shock.

Installation Requirements

! WARNING!

1. Always ground unit

- The DKN400 and DKN600 operate on a 115V power source.
- The DKN810 and DKN900 operate on a single-phase 220V power source. Please consult your local electrical contractor for power connections.
- Be sure to connect the earth wire (the green cable of power cord) to the grounding conductor or ground terminal to prevent accidents caused by electric leakage.
- Do not connect the earth wire to gas or water pipes. Not following these instructions can result in fire or electric shock.
- Do not connect the earth wire to the ground for telephone wire or lightning conductor.
- Do not use a branching receptacle, which may cause heat generation.

2. Choose a proper place for installation

- Do not install this unit in the following areas:
 - ◆ Areas with a rough or dirty surface.
 - ◆ Areas where flammable or corrosive gases are generated.
 - ◆ Areas where ambient temperatures exceed 35°C.
 - ◆ Areas where ambient temperatures fluctuate.
 - ◆ Areas under direct sunlight.
 - ◆ Areas with excessive humidity and dust.
 - ◆ Areas with constant vibration.
- Install this unit with sufficient space surrounding this unit as shown below. The exhaust opening is provided on top of the unit for DKN400, DKN600 and at the back of the unit for DKN810 and DKN900.

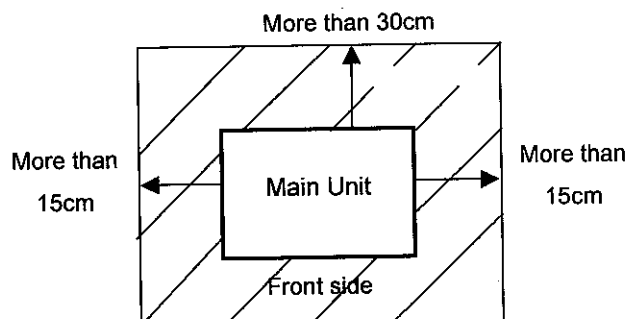

Installation Requirements

3. Do not use this unit in areas where flammable or explosive gasses are present (Refer to page 45 "List of Dangerous Substances".)

	<ul style="list-style-type: none">• Never use this unit in an areas where flammable or explosive gasses are present. This unit is not explosion-proof. An arc may be generated when the power switch is turned ON or OFF, and fire/explosion may result.			
		<ul style="list-style-type: none">• Never use explosive or flammable substances or substances that include explosive or flammable ingredients. Explosion or fire may occur.	<p>Flammable substances</p>	

Installation Requirements

4. Do not modify



- Modifications of this unit is strictly prohibited.

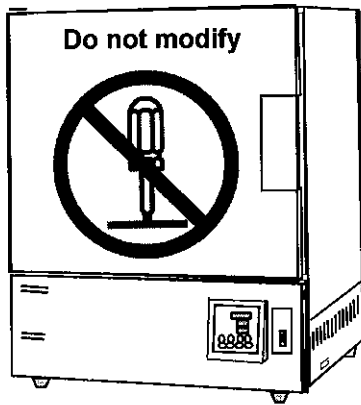

5. Install on flat surface



- Install this unit on a flat surface. Not doing so could cause vibrations to unit causing malfunction.

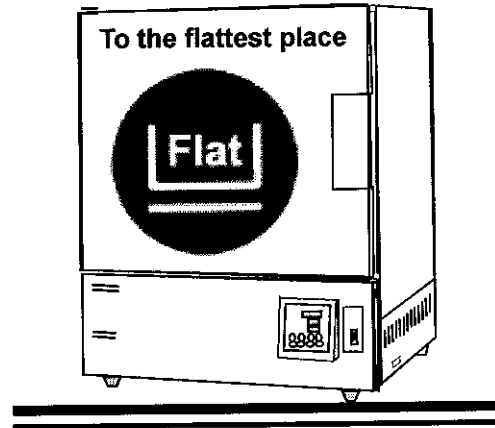

CAUTION!

6. Do not overload samples



- The withstand load of shelf is 15kg (uniform load) Set the samples apart each other.

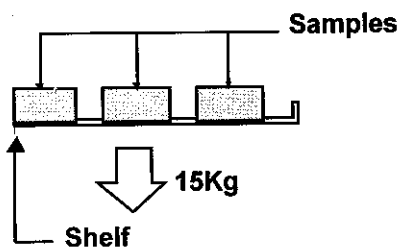

7. Leave adequate space between samples



- The temperature in this unit cannot be controlled properly if samples are set with inadequate spacing. Be sure set samples apart each other as shown below to assure 30% or more space to acquire accuracy of temperature.

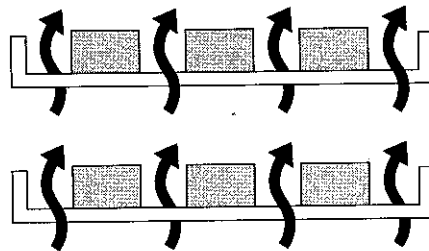

Provide samples with 30% space

Installation Requirements

8. Choose a correct power distribution board or receptacle

- ! Choose a correct power distribution board or receptacle to meet the unit's rated electric capacity as follows:

Electric capacity:

DKN400: 115V AC, 12A	DKN810: 1 ϕ 220V AC, 14A
DKN600: 115V AC, 14A	DKN900: 1 ϕ 220V AC, 17A

NOTE)

In the event that the unit does not run even after turning ON the power, please follow the following simple steps: Inspect whether the voltage of the main power is lower than the specified value, or whether other device(s) uses the same power line of this unit.

9. Before/after installation

- ! Injuries can occur if this unit falls or moves due to earthquake, impact, etc. Take appropriate measures to prevent this from occurring.
- Contact with this unit may cause burns during and just after operation. Take appropriate measures to prevent this from occurring.
- As a safety precaution, be sure to lock the casters on the DKN810 and DKN900 series.

10. Handling the power cord

- ⊘ The number of shelves equipped with each unit varies depending on the model (2 to 8). One of these shelves (two for DKN900) is factory installed on the lowest setting with screws. Set the other shelf or shelves in place.
- ! The temperature of the shelf/plate is usually higher than the set temperature because the heater is located under it. Be cautious as this can cause burns to your sample. To prevent such accidents, the shelf is fixed with screws as shown in the figure. Be sure to provide sufficient space between the shelf and sample in case the shelf must be removed due to the size of your sample. Do not put the sample directly on the bottom plate of chamber.

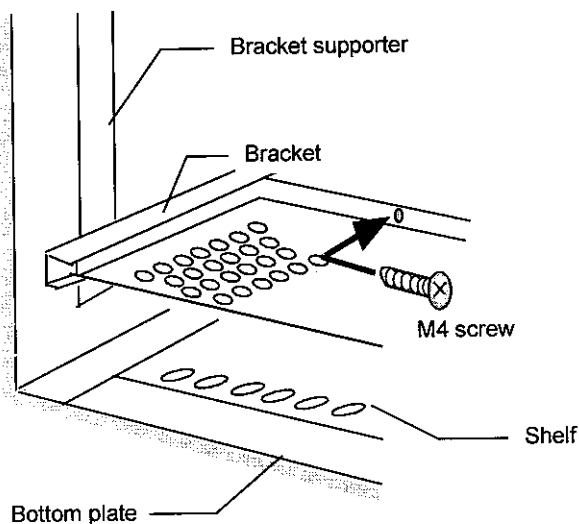

Installation Requirements

11. Handling the power cord



- Do not tangle the power cord. This will cause overheating and possibly a fire.
- Do not bend or twist the power cord, or apply excessive tension to it. This may cause a fire or electrical shock.
- Keep the power cord away from any heating equipment such as a room heater. The cord's insulation may melt and cause a fire or electrical shock.



- If the power cord is damaged (wiring exposed, breakage, etc.), immediately turn off the power at the rear of this unit and shut off the main supply power. Contact your sales or service representative for a replacement power cord.
- Connect the power plug to a receptacle supplied with the appropriate power and voltage.

Main Unit

DKN400/600

Front view

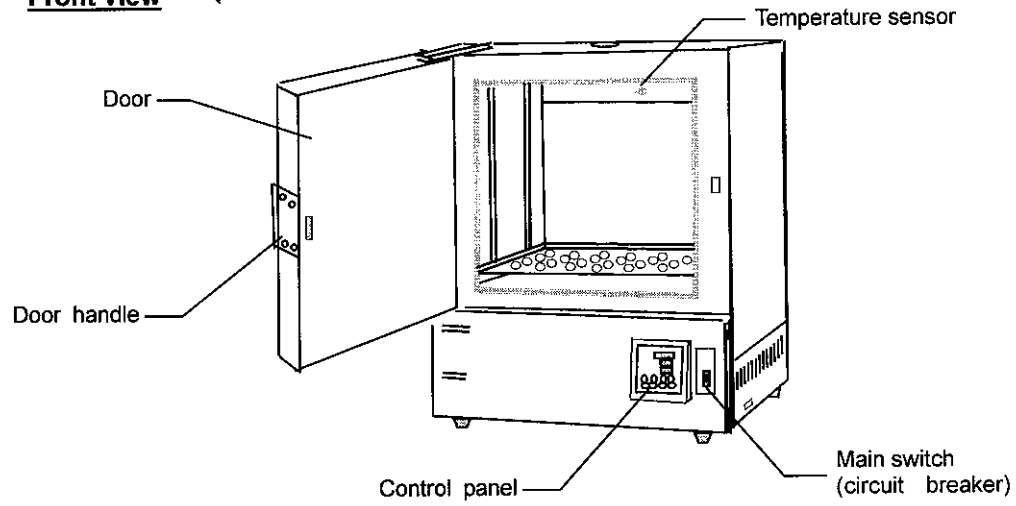

Rear view

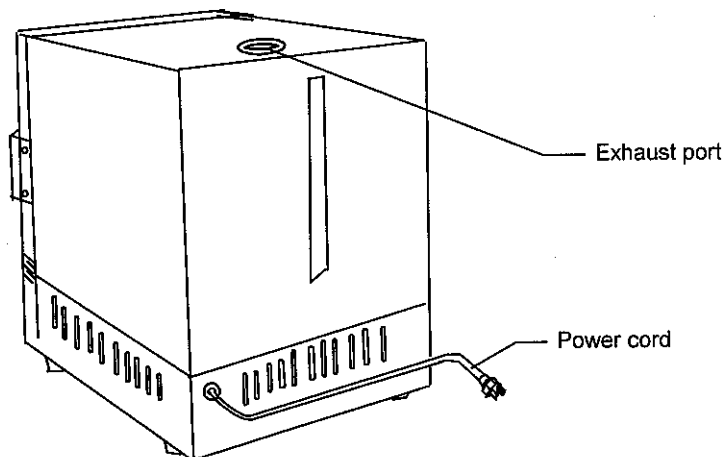

Main Unit

DKN810

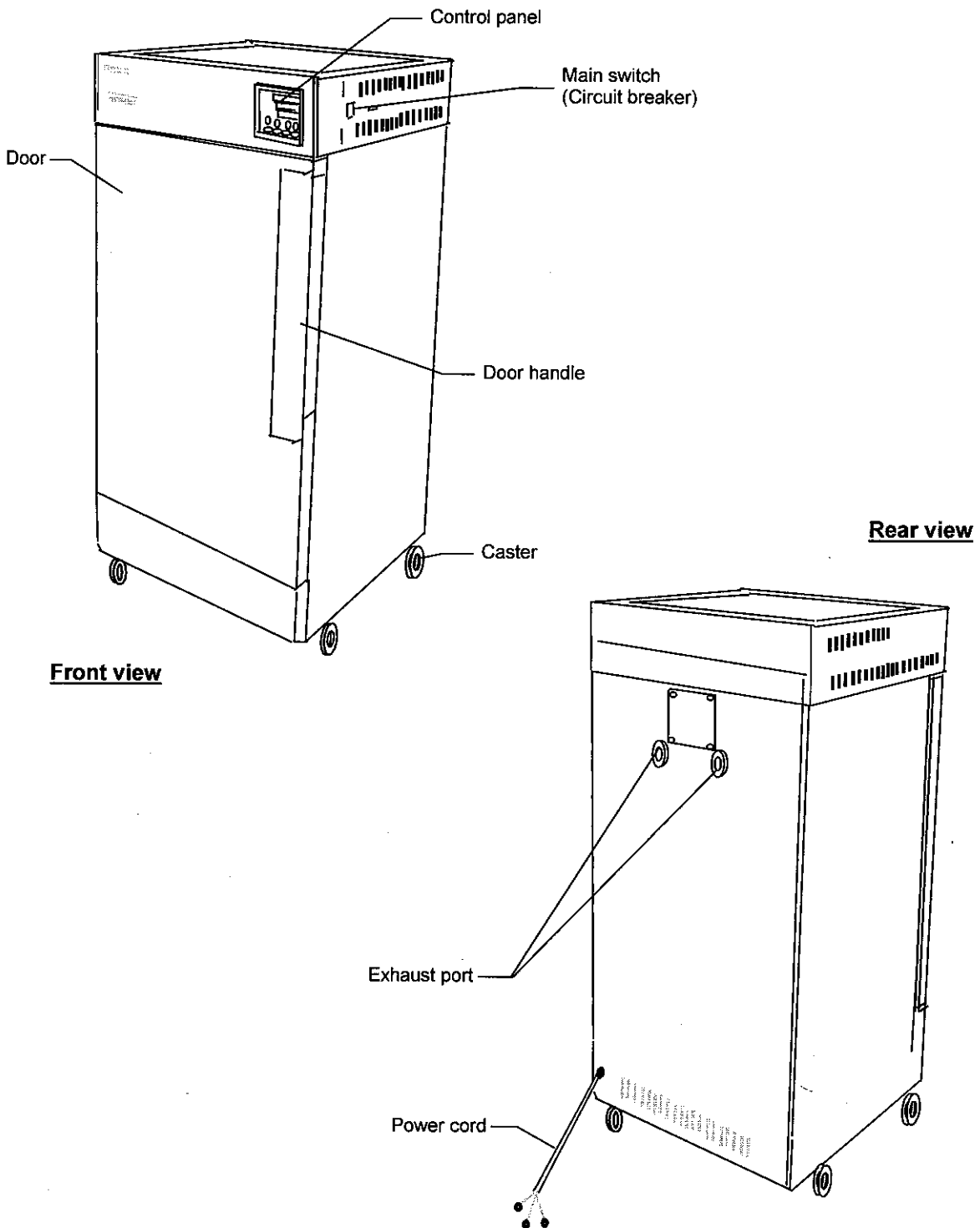

Main Unit

DKN900

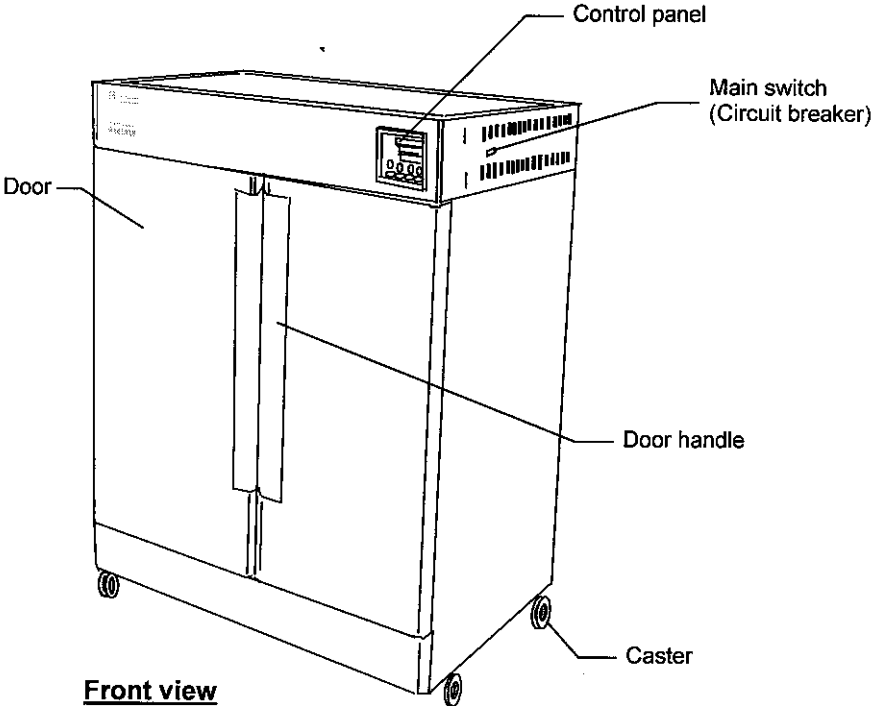

Rear view

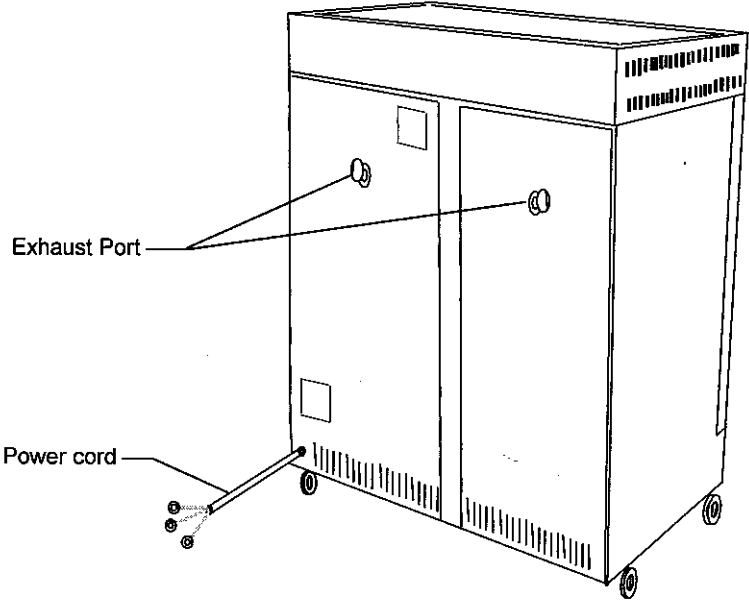



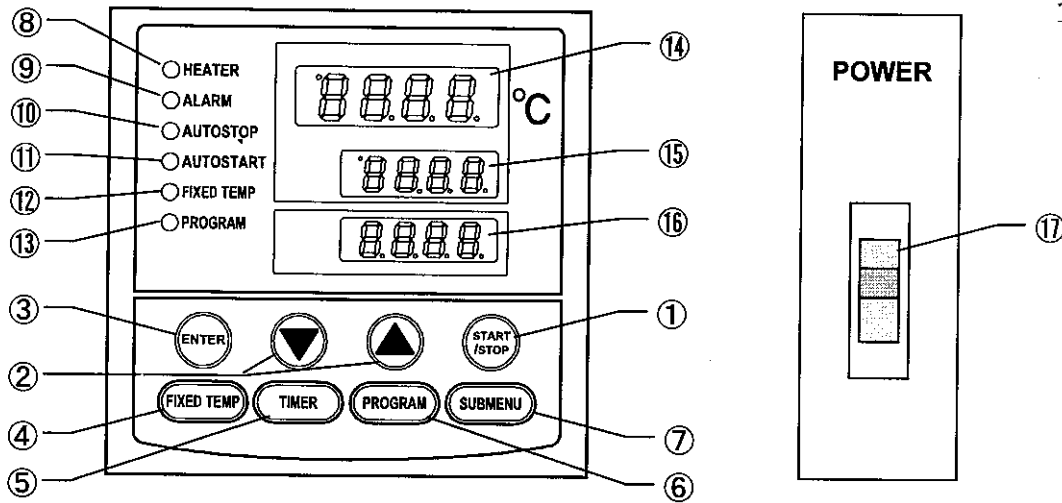





Control Panel

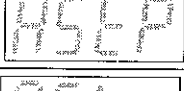
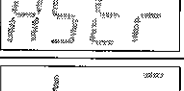
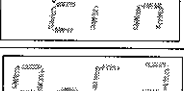

①	START/STOP Key :	Starts/stops the operation.
②	▲▼ keys :	Uses for rising UP/lowering DOWN the setting value.
③	ENTER Key :	Settles the inputted value.
④	FIXED TEMP Key :	Chooses the fixed temperature operation.
⑤	TIMER Key :	Chooses the timer operation (Quick Auto Stop/Auto Stop/Auto Start).
⑥	PROGRAM Key :	Chooses the program operation or program creation mode.
⑦	SUBMENU Key :	Uses for setting the overheating prevention temperature, calibration offset temperature, key lock function, or program repeat function.
⑧	HEATER Lamp :	Lights while the heater works.
⑨	ALARM Lamp :	Lights up when an error occurs. (Buzzer sounds simultaneously.)
⑩	AUTO STOP Lamp :	Blinks while setting quick auto stop timer or auto stop timer. Lights while quick auto stop timer or auto stop timer is running.
⑪	AUTO START Lamp :	Blinks while setting auto start timer. Lights while auto start timer is running.
⑫	FIXED TEMP Lamp :	Blinks while setting fixed temperature operation. Lights while fixed temperature operation is running.
⑬	PROGRAM Lamp :	Blinks while setting program operation. Lights while program operation is running.
⑭	Measurement Temperature Display :	Displays the measured temperature, setting character, alarm information.
⑮	Setting Temperature Display :	Displays the set temperature, set value for timer mode, remaining time.
⑯	Overheating Prevention Temperature Display :	Displays the set temperature for overheat prevention device.
⑰	Power Switch : (Circuit breaker)	Turns ON/OFF the main power.

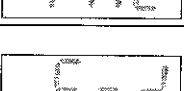
Controller Characters

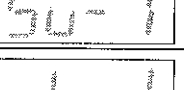
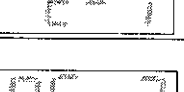
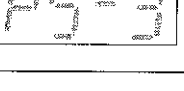
The VS4 controller:

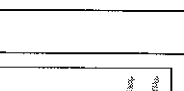
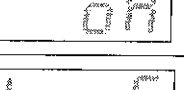
Character	Identifier	Name	Purpose
	FIX	Fixed Temperature Setting Mode	Used for starting the fixed temperature operation.
	Sv	Temperature Setting	Used for setting the temperature.
	ASTP	Timer Setting Mode Display	Represents the setting of quick auto stop or auto stop operation.
	AStr	Timer Setting Mode Display	Represents the setting of auto start operation.
	tim	Time Setting	Used for setting the time.
	PrG3	Program Type	Used for choosing program type from 1 to 3. (Refer to Page 24 "Program Operation".)
	PAt	Program Pattern	Used for choosing program pattern. (Refer to Page 24 "Program Operation".)
	End	Time Up	Displays when the timer operation is completed or while inputting number of program steps. (Refer to Page 24 "Program Operation".)
	Sv-1	Program Temperature Setting	Used for setting the temperature for each step in the program. (Sv-1 to Sv-30 is shown.)
	t-1	Program Time Setting	Used for setting the time for each step in the program. (t-1 to t-30 is shown.)
	PS-3	Step Number to be Repeated	Used for choosing the step number to be repeated under the program operation with repeat function. (Refer to Page 28 "Use program repeat function".)
	Pc-2	Repeating Times	Used for setting the repeating times under the program operation with repeat function. (Refer to Page 28 "Use program repeat function".)
	cAL	Calibration Offset Setting	Used for inputting the calibration offset temperature. (Refer to Page 31 "Other Function".)
		Zero/Span Calibration	
	oH	Overheating Prevention Setting	Used for setting temperature for overheating prevention device. (Refer to Page 17 "Overheat Prevention Device".)
	Lock	Key Lock	Locks the keys on control panel to protect from unnecessary operation. (Refer to Page 31 "Other Function".)

* Also refer to Page 16 "Operational Characters".

Operational Mode and Function List

The operational modes of this unit are as follows:

No.	Name	Description	Page
1.	Fixed Temperature	Pressing the FIXED TEMP key enters you into the fixed temperature operation mode. Pressing it again enters you into the temperature setting mode. The "▲▼" keys are used to set temperature. Pressing the START/STOP key starts or stops operation.	18
2.	Quick Auto Stop	This operation is used to specify the period to automatically stop during operation. The period to stop operation can be set by pressing the TIMER key during fixed temperature operation. The "▲▼" keys are used to set the time. Pressing the START key starts the quick auto stop operation. This activates the timer function and stops the operation automatically after the specified period.	19
3.	Auto Stop	This operation is used to specify the automatic stop time in the fixed temperature operation mode. Pressing the TIMER key displays "AS t p". The set temperature "SV" can be set by pressing the ENTER key. The operation time "tim" can be set by pressing it again. Pressing the START/STOP key starts the auto stop operation.	20
4.	Auto Start	This operation is used to specify the automatic start time after the unit is powered on. Pressing the TIMER key displays "AS t r". The set temperature "SV" can be set by pressing the ENTER key. The operation time "tim" can be set by pressing it again. Pressing the START/STOP key starts the auto start operation.	22
5.	Program Operation	This operation is used to change the temperature according to the set temperature and time. Pressing the PROGRAM key displays "PrG1". Press it again to select the program mode. Press the ENTER key to select the pattern "PA t". Press the ENTER key to display "End". Input the number of patterns to be used. Input the temperature and time of patterns "SV-n" and "t-n" respectively.	24

NOTE) It is not possible to change modes during operation. If needed, you will need to stop operation.

Operation Modes and Functions

No.	Name	Description	Page
1.	Auto overheating prevention	This function is set to be automatically activated (auto reset) when the temperature exceeds the set temperature by 12°C.	17
	Overheating prevention	Though the device shares the power source, display, and key input with the controller, it is equipped with an independent temperature measurement circuit, CPU, sensor and output circuit. The Overheat prevention temperature can be set using the control panel. The unit stops operation when the device is activated. The unit starts operation again when the POWER switch is pressed again (manual reset).	
2.	Calibration offset	The calibration offset function is for calibrating the difference between the required internal temperature and control temperature (sensor temperature) of the controller. This unit can be calibrated toward either positive or negative side of the temperature range.	31
3.	Zero/Span Calibration	This function is used for zero/span calibration of input. Calibration is effected by first applying the appropriate signal for zero and span points of the input range being used and then by correcting the errors.	
4.	Overheating prevention temperature calibration	The temperature of the overheat prevention device is automatically corrected when the temperature of controller is collected.	-
5.	Recovery after power failure	The unit starts operation and continues with the same conditions as before the power failure occurred. Press the START/STOP key to start the unit again.	-
6.	Parameter Lock	This function locks the established parameters. It can be set and cancelled by pressing the SUBMENU key.	31

Operational Characters

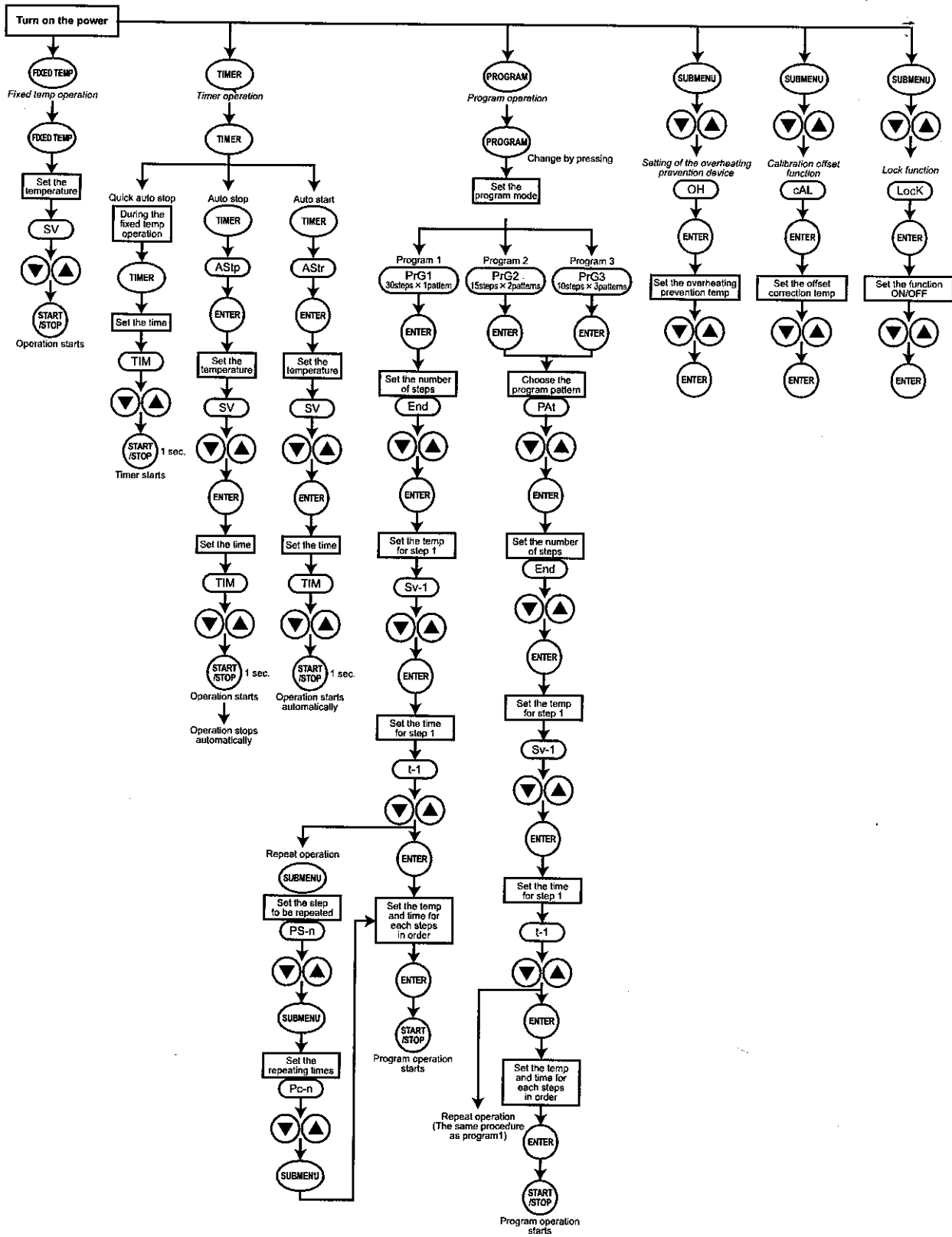

Overheat Prevention Device

This unit is equipped with an overheat prevention device (manual reset) that consists of independent temperature measurement circuit, CPU, sensor and output circuit (shares power source, display, and key input with the controller) in addition to the automatic overheat prevention function (auto reset).

Setting range/function

The unit is equipped with safety functions to prevent overheating. One is built-in in the controller and is factory set to be automatically activated when the temperature exceeds the set temperature of controller by 12°C. The other is integrated into the controller, and can be set through the controller.

WARNING: The setting range is 0°C to 1300°C. The controller in this unit is also utilized in high temperature furnaces. Exercise extreme care in changing the overheat temperature which is factory set at 270°C.

In the event that the temperature exceeds the set temperature to reach that of the overheat prevention device, the circuit automatically shuts off and "Er19" is displayed with visual and audible signals.

Should the device be activated, "Er19" continues to be displayed until the power is turned off.

Temperature setting procedure

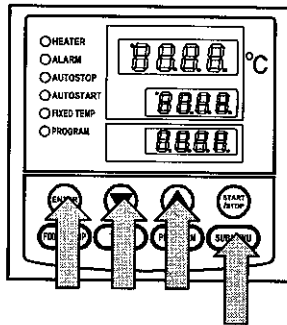

1. Turn the power on (breaker on front panel)

The default value is displayed for about four seconds after turning on the power. The screen then displays the initial setting. The current temperature in unit, operation mode character, and set temperature of overheat prevention device are displayed on respective screens.

2. Set the temperature for overheat prevention

- ① Press the SUBMENU key.
- ② Press the "▼▲" several times to select the setting character of overheat prevention temperature "OH".
- ③ Press the ENTER key. The current set temperature is displayed and flashes on the set temperature screen.

Note: To prevent improper operation, set the value 12°C or more over the set temperature of controller.

- ④ Select the value using the "▼▲" and then press the ENTER key. This completes the setting.

Notes:



- The standard set temperature of device is "the maximum set temperature of unit plus 12°C" or "set temperature plus 12°C". If the unit does not perform properly, increase it by 5°C more.
- The setting range of the overheat prevention device is 0°C to 1300°C. Improper settings can cause malfunctions, e.g. activated during increasing in temperature, or accidents such as fire. To prevent such matters, be sure to set the proper value. **The temperature is set to 272°C at factory shipment. Do not set the value higher than this. (DKN900 temperature is set to 222°C.)**
- In some cases, the overheat prevention device may be activated by fault when its yield temperature is set to approximately room temperature.
- The purpose of the overheat prevention device is to protect the unit from overheating. It does not intend to protect the samples, or to protect them from accidents caused by the use of explosive or flammable products.

Fixed Temperature

Fixed temperature

1. Turn power on (breaker on front panel)

- ❖ The default value is displayed for about four seconds after turning the power on. The screen then displays the initial setting. The current temperature, operation mode character, and set temperature of the overheat prevention device are displayed on respective screens.

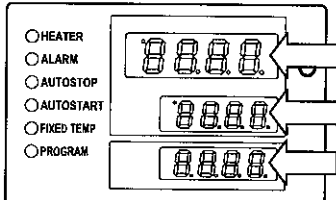

Measured temperature screen:

Displays the current temperature.

Set temperature screen:

Displays the operation mode character. (Refer to Page 13)

Overheat prevention screen:

Displays the set temperature of overheat prevention device

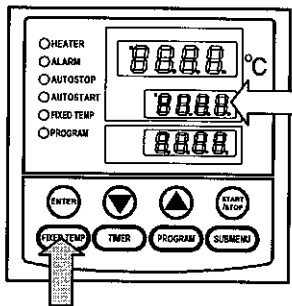

2. Select the operation mode

- Press the FIXED TEMP key to display "FIX", which indicates the fixed temperature operation, on the center display screen.

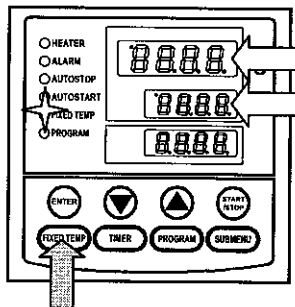

3. Set the temperature

- Press the FIXED TEMP key again.
- The set temperature screen displays the character "SV" which indicates the temperature setting. It also displays and flashes the current set temperature. The FIXED TEMP lamp flashes also.
- Set the temperature by pressing the "▼▲" keys.

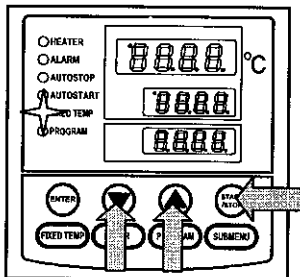

4. Start operation

- Press the START/STOP key for about one second. The unit begins its operation and the flashing FIXED TEMP lamp illuminates.

5. Stop operation

- Press the START/STOP key for about one second. The unit stops operation and the FIXED TEMP lamp turns off. The screen returns to the initial setting screen.

To correct or check setting...

Press the FIXED TEMP key again to correct or check the setting.

Changing the set temperature during operation is also possible by pressing the FIXED TEMP key.

Quick Auto Stop

Quick auto stop

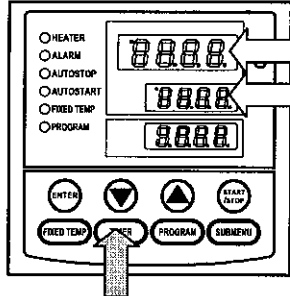

This operation is used to specify the period to automatically stop during operation.

1. Set the stop time in fixed temperature operation

- Check that the FIXED TEMP lamp lights on and that the unit is operating.
- Press the TIMER key.
- The measured temperature screen displays the character "tim", which indicates the timer setting. The set temperature screen displays and flashes the current set time.
- Select the time by pressing the "▼▲" keys.

Timer function:

- The maximum set time is "999 hours and 50 minutes".
- The time can be set in increments of a minute under 99 hours and 59 minutes.
- It can be set in increments of ten minutes over 100 hours.
- The "▼▲" keys can quickly change the set time when continuously pressed. Press them consecutively when fine adjustment is needed.

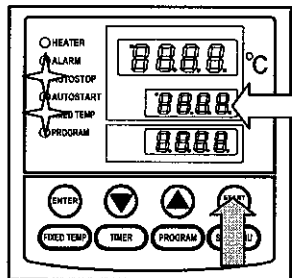

2. Start timer

- Press the START/STOP key for one second after selecting the desired time.
- Timer operation starts with the FIXED TEMP and AUTO STOP lamps on.
- The timer is activated and the START/STOP key is pressed.

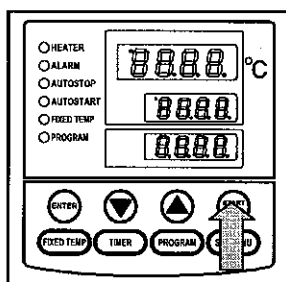

3. Stop/terminate timer

- The operation stops automatically at setting time.
- Buzzer alarms for about five minutes during operation stop.
- The set temperature screen displays the character "End", which indicates termination of operation, with the FIXED TEMP and AUTO STOP lamps on. Press the START/STOP key to terminate the timer operation mode. The screen returns to the initial setting screen.

To correct or check setting...

Changing the set temperature during operation is possible by pressing the FIXED TEMP key. Press the ENTER key after changing the setting.

Changing the set temperature during operation is available by pressing the FIXED TEMP key. Press the ENTER key after changing the setting.

Press the ▼ key to display the set temperature, operation mode, and residual time on the set temperature screen.

Auto Stop

Auto stop operation

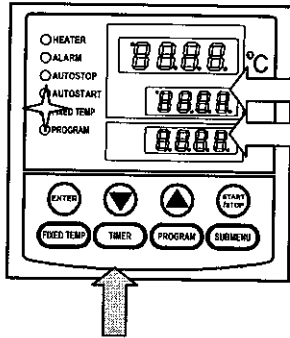

This operation is used to specify the automatic stop time in the fixed temperature operation mode.

1. Set stop time

- ① Press the TIMER key on the initial screen.
Press the TIMER key again. The set temperature screen displays the character "AstP", which indicates and flashes the auto stop operation.
- ② Press the ENTER key.
The measured temperature screen displays the character "SV", which indicates the temperature setting. The set temperature screen displays and flashes the current set temperature. The AUTO STOP lamp flashes as well.
- ③ Set the temperature using the "▼▲" keys.
- ④ Press the ENTER key again.
The measured temperature screen displays the character "tim", which indicates the timer setting. The set temperature screen displays and flashes the current set time.
- ⑤ Set the time using the "▼▲" keys.

Timer function:

- The maximum setting time is "999 hours and 50 minutes".
- The time can be set in increments of a minute under 99 hours and 59 minutes.
- It can also be set in increments of ten minutes over 100 hours.
- The "▼▲" keys can quickly change the set time when it is continuously pressed. Press them consecutively when fine adjustment is needed.

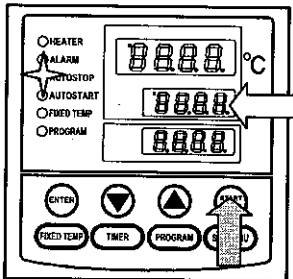

2. Start timer

- Press the START/STOP key for one second after selecting the desired time.
- Timer operation starts with the AUTO STOP lamp on.
- The timer is activated and the interior temperature (measured temperature) reaches to the set temperature.

Auto Stop

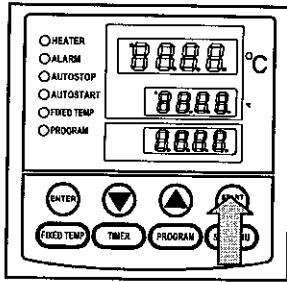

3. Stop/terminate timer operation

- The operation stops automatically at setting time.
- Buzzer alarms for about five seconds during operation stop.
- The set temperature displays the character "End", which indicates termination of operation, with the FIXED TEMP and AUTO STOP lamps on. Press the START/STOP key to terminate the timer operation mode. The screen returns to the initial setting screen.

To correct or check setting...

Changing the set temperature or time during operation is possible by pressing the TIMER key. Use the "▼▲" key to change the set value. Press the ENTER key respectively after changing the setting.

Press the "▼" to display the set temperature, operation mode, and residual time on the set temperature screen.

Auto Start

Auto start operation

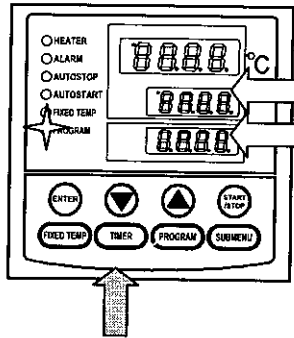

This operation is used to specify the automatic start time after the unit is powered on.

1. Set start time

- ① Press the TIMER key on the initial screen.
Press the TIMER key again. The set temperature screen displays the character "Astr", which indicates and flashes the auto start operation.
- ② Press the ENTER key.
The measured temperature screen displays the character "SV", which indicates the temperature setting. The set temperature screen displays and flashes the current set temperature. The AUTO START lamp flashes as well.
- ③ Set the temperature using the "▼▲" keys.
- ④ Press the ENTER key again.
The measured temperature screen displays the character "tim", which indicates the timer setting. The set temperature screen displays and flashes the current set time.
- ⑤ Set the time using the "▼▲" keys.

Timer function:

- The maximum setting time is "999 hours and 50 minutes".
- The time can be set in increments of a minute under 99 hours and 59 minutes.
- It can also be set in increments of ten minutes over 100 hours.
- The "▼▲" keys can quickly change the set time when it is continuously pressed. Press them consecutively when fine adjustment is needed.

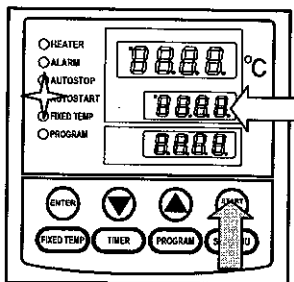

2. Start timer operation

- Press the START/STOP key for one second after deciding the time.
- Timer operation starts with the AUTO START lamp lighting on.

Auto Start

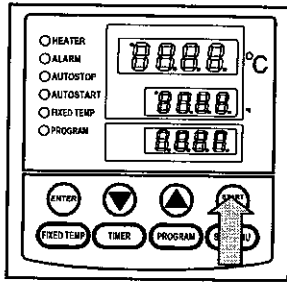

3. Stop/terminate timer operation

- The operation automatically starts at setting time.
- Press the START/STOP key for one second to stop or terminate operation. The screen returns to the initial setting screen.

To correct or check setting...

Changing the set temperature or time during operation is possible by pressing the TIMER key. Use the "▼▲" keys to change the set value. Press the ENTER key after changing the settings. Please note that you will not be able to change parameters after the unit begins operation. In this event, stop the operation by pressing the START/STOP key, and set the value again.

Press the "▼" key to display the set temperature, operation mode, and residual time on the setting temperature screen.

Program Operation

This operation is used to change the temperature according to the set temperature and time.

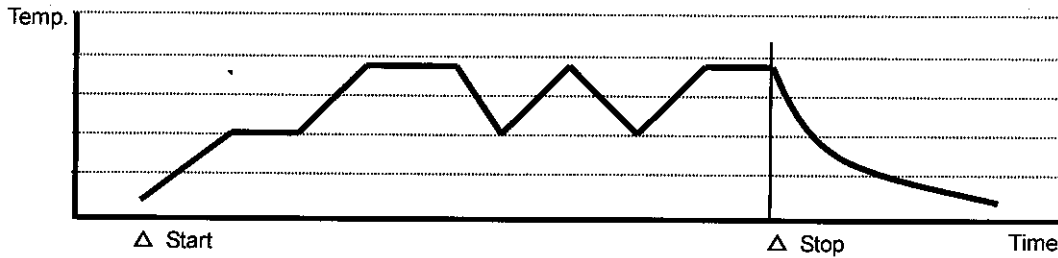

Program types

Six patterns of program types maximum can be input.

PrG1	-	1 program pattern using 30 steps maximum can be created.
PrG2	PAt1	2 program patterns using 15 steps maximum can be created.
	PAt2	
PrG3	PAt1	3 program patterns using 10 steps maximum can be created.
	PAt2	
	PAt3	

Inputting a program before program operation

- ① Check the number of steps in a created program and their set temperature/time. Refer to the program preparation sheet located on pages 29 and 30.
- ② Check the temperature rise/fall capability of the unit. Set the time within the capability above. For instance, if the unit has capability of increasing or decreasing temperature by 3°C within ten minutes, about 35 minutes is needed to increase or decrease temperature by 10°C from current temperature.

Repeat function:

Repeat function is used in the event that the operation uses the same program, repeating the same program steps. Refer to page 28 for further instructions.

- ③ Verify that the controller has sufficient free patterns for the number of steps to be created. The steps using the repeat function mentioned above are not counted.

Temperature fall/rise curve for DKN type

The temperature fall and rise curve for DKN type are shown below.

The numeric value indicates the necessary time between temperatures (ex: about 15 minutes is needed to increase temperature from 100°C to 150°C for DKN600). The temperature stability time after reaching the set temperature will need to be added. Be sure to run a test prior to setting the optimum time.

Condition: room temperature 20°C, no load.

(Unit: Minute)

	DKN400		DKN600		DKN810		DKN910	
	Rise	Fall	Rise	Fall	Rise	Fall	Rise	Fall
260°C	25	-	25	-	25	-	At 210°C 15	-
200°C	10	20	15	20	15	20	25	6
150°C	5	20	10	20	10	25	15	25
100°C	5	30	10	30	10	40	10	40
50°C	5	60	5	75	5	60	5	180

The above data changes by final products.

Program Operation

Creating a Program

A sample program pattern is illustrated below.

1. Sample program pattern

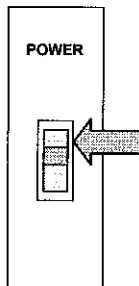
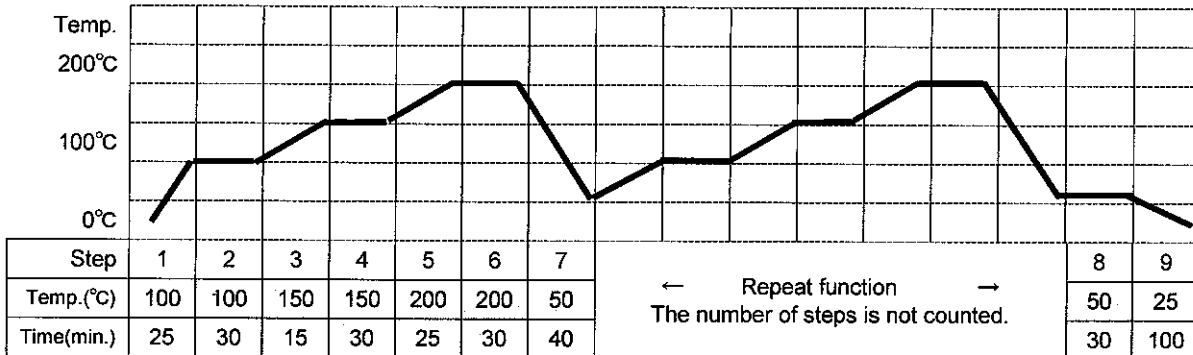

1. Turn the power on

- Turn the power switch on.
- The display on the controller illuminates.
- The initial screen is displayed for about four seconds, then the measured temperature (temperature in chamber) is displayed.
- ❖ The initial screen displays the software version, sensor used, and set temperature of the overheating prevention device.

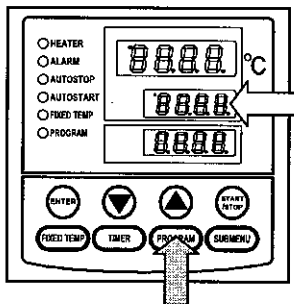

2. Select program mode/program pattern

- ① Press the PROGRAM key once.
The measured temperature screen displays the previous program mode.
Press the PROGRAM key again to display the next program mode.
 - ② Select the mode and press the ENTER key.
 - When PrG1 is selected, the measured temperature screen displays "End".
 - When PrG2 is selected, the measured temperature screen displays the program pattern "PAT1". For the pattern of PrG2, select "1" or "2" using the "▲▼" keys. Press the ENTER key again. The measured temperature screen displays "End".
 - When PrG3 is selected, the measured temperature screen displays "PAT1". For the pattern of PrG3, select "1", "2" or "3" using the "▲▼" keys. Press the ENTER key again. The measured temperature screen displays "End".
- ❖ PrG1, PrG2, or PrG3 can be selected in the program sample above. Up to nine steps can be used.

Program Operation

The sample program below explains the methods of utilizing PrG3 programs.

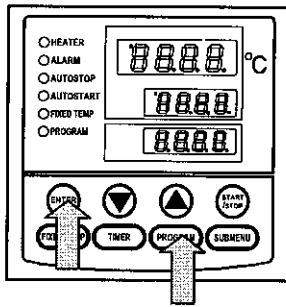

4. Register program

- ① Select PrG3
- ② Input the number of steps, temperature and time for respective steps using the program creation sheet.
- ③ Press the ENTER key. The PA t 1 is displayed and flashing. ("End" is displayed if PrG1 is selected. In this case, proceed to step ⑥.)
- ④ Select an unused pattern from Pat1, Pat2 and Pat3 using the "▲▼" keys.
- ⑤ Press the ENTER key. "End" is displayed and step number "10" is displayed and flashing.
 - ❖ "End" is a character, which indicates the total number of steps to be used. "9" will be inputted here.
- ⑥ INPUT "9", which is the total number of steps to be used, using the "▲▼" keys.
- ⑦ Press the ENTER key. The character "SV-1", indicating the set temperature of the first step, is displayed. The current set temperature is also displayed and flashing.
- ⑧ Set the temperature of the first step using the "▲▼" keys. "100" is inputted here to set the temperature to 100°C.
- ⑨ Press the ENTER key. The character "t-1", indicating the set time of the first step, is displayed. The current set time is also displayed and flashing.
 - ❖ Before setting the time, check the temperature rise/fall capability of unit.
 - ❖ For example, about 60 minutes is needed to increase the temperature from room temperature to 260°C for DKN400 (75 minutes for DKN600 and 810 types). When the current temperature is to be 25°C, it takes about 3 minutes to increase the temperature by 1°C, and takes about 75 minutes until it reaches 210°C. Also allow for temperature stability time.
 - ❖ The setting time of timer is 999 hours and 50 minutes maximum.
- ⑩ After the time is set, press the ENTER key.
- ⑪ The character "SV-2", indicating the set temperature of the second step, is displayed. In the same way, input the temperature and time for respective steps using the program creation sheet.

A different method is needed when program repeat function is used. In this case, press the SUBMENU key after setting the time (t-7 in the example) in the step where the repeat operation is to be used (Step 7 in the example). This enters the repeat function setting mode.

 - ❖ Follow the "Use program repeat function" on page 28 for further information on program repeat function.
- ⑫ The screen returns to the initial setting screen after the settings of both temperature and time are completed.

Verify run:

Be sure to check the set temperature and time by operating the unit unloaded before performing an actual run with samples.

Program Operation

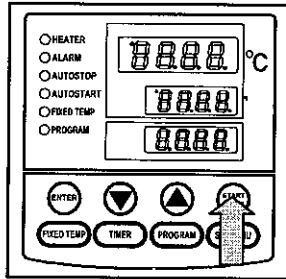

5. Start program operation

- Press the START/STOP key for about one second. The previous program operation begins.
- The PROGRAM lamp is illuminated and the set temperature screen displays the step currently under operation.
- ❖ Press the "▼" key to check the set temperature and residual time of step currently under operation on the set temperature screen.

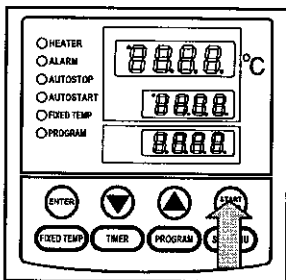

6. End program operation

- Buzzer alarm continues for about five seconds during operation stop.
- The measured temperature screen displays the character "END", which indicates the termination of program.
- Press the START/STOP key to return to the initial screen.

Timer function:

- The maximum setting time is "999 hours and 50 minutes".
- The time can be set in increments of a minute under 99 hours and 59 minutes.
- It can also be set in increments of ten minutes over 100 hours.
- The "▼▲" keys can quickly change the setting time when continuously pressed. Press them consecutively when fine adjustment is needed.

To correct or check settings...

Press the FIXED TEMP key to correct the created program or to check the set value. The screen returns to the previous, where corrections are possible.

The final screen is displayed when the FIXED TEMP key is pressed once.

Note: Corrections should be made on the program setting screen.

Wait mode in program operation

The succeeding steps do not start if the measured temperature does not reach, or exceeds the set temperature. This unit, however, is factory set to carry out the next step if the measured temperature is within $\pm 3^{\circ}\text{C}$ of the set temperature.

Program Operation

Use program repeat function

This section explains the procedures in performing repeat program patterns in program operation.

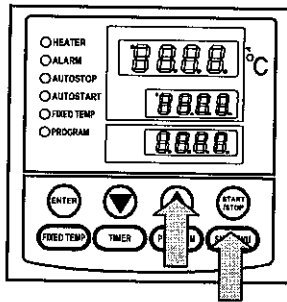

This procedure sets the number of steps to be repeated "PS-n" and repeat times "Pc-n" (n: step number).

- ① Press the SUBMENU key after setting the time (t-7 in the example) in the step where the repeat operation is to be used (Step 7 in the example). This enters the repeat function setting mode.
- ② The measured temperature screen displays the character "PS-n", which indicates the step to be repeated in the program pattern. The measured temperature screen indicates "PS-7" in the sample as the repeat function is used at the seventh step. You may input step number 1 to 7 in the set temperature display screen. Enter the number (1 in the example) using the "▲▼" keys.
- ③ Press the SUBMENU key.
The measured temperature screen displays the character "Pc-n", which indicates the repeat times. Enter the value of repeat times (2 in the example) using the "▲▼" keys.
- ④ The screen proceeds to the next step when the SUBMENU key is pressed again. The screen to input the Sv-8 is displayed next.

To correct or check settings...

Correcting settings during the repeat setting mode is not possible.

To correct or check the setting, end the setting of the current set input. Press the FIXED TEMP key after the temperature screen for the next step appears. The screen returns to the previous and re-setting is possible.

Note: Corrections should be made on the program setting screen.

Program Operation

Program Preparation Sheet 2

(Note: Copies of this sheet should be made)

Register with:	PrG1 PrG2 PrG3	PAT1 PAT2 PAT3	Number	
Project Name				Date
				Programmer

Input Value

	Temperature (°C)	Time (min.)	Repeat Function
Step 1		:	To/Times
Step 2		:	/
Step 3		:	/
Step 4		:	/
Step 5		:	/
Step 6		:	/
Step 7		:	/
Step 8		:	/
Step 9		:	/
Step 10		:	/
Step 11		:	/
Step 12		:	/
Step 13		:	/
Step 14		:	/
Step 15		:	/
Step 16		:	/
Step 17		:	/
Step 18		:	/
Step 19		:	/
Step 20		:	/
Step 21		:	/
Step 22		:	/
Step 23		:	/
Step 24		:	/
Step 25		:	/
Step 26		:	/
Step 27		:	/
Step 28		:	/
Step 29		:	/
Step 30		:	/

Other Functions

Calibration offset

Calibration offset is a function, which corrects the difference between the temperature in unit and that of the controller (sensor temperature). The function parallel corrects the difference to the positive or negative side within the whole temperature range of unit. This function can be set or cancelled through the SUBMENU key.

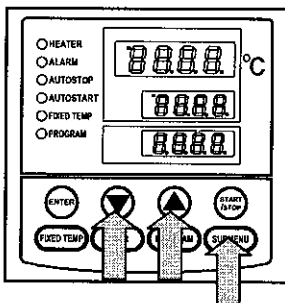
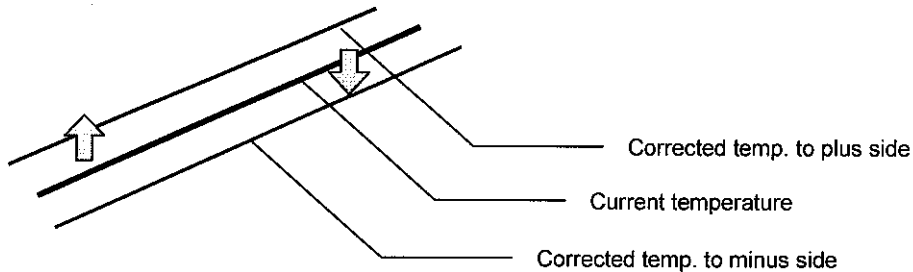

- ① Start operation with the target set temperature. Check the temperature in chamber (temperature of sample) with a thermometer after it is stabilized.
- ② Check the difference between the set temperature and that in chamber (temperature of sample).
- ③ Press the SUBMENU key. Select the character "cAL", which indicates the calibration offset, using the "▲▼" keys, and press ENTER.
- ④ Input the difference using the "▲▼" keys and press ENTER. This completes the setting.

❖ The offset setting range is +99°C to the positive side and -99°C to the negative side.

When it is set to the negative side, the temperature on the measured temperature screen falls by the set temperature, while the temperature in the chamber rises.

When it is set to the positive side, the temperature on the measured temperature screen rises by the set temperature, while the temperature in the chamber falls.

❖ This unit has a two-point calibration function, which performs offset between low-temperature and high-temperature zone. Please consult your sales representative when validating temperature controller.

Lock function

This function locks the parameters previously set. This function can be set or cancelled through the SUBMENU key.

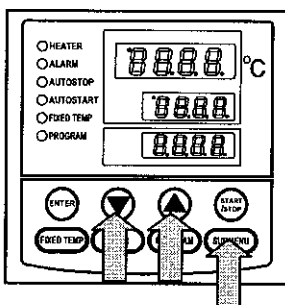

- ① Press the SUBMENU key. Select the character "Lock", which indicates the lock value, using the "▲▼" keys, and press ENTER.
- ② The set temperature screen displays "OFF". The set value is locked when it is turned "on" using the "▲" key.
- ③ Press the SUBMENU key again to cancel the lock. Select the character "Lock", which indicates the lock of the set value, using the "▲▼" keys, and press ENTER. Select "OFF" with the "▼" key and press ENTER to cancel the function.

❖ All keys other than the START/STOP and SUBMENU keys are locked when the lock function is on.

WARNING!

 If smoke or strange odors come out of this unit, turn the power, circuit breaker, and main power off immediately. Contact Yamato or your service representative for inspection. Not following these procedures may result in fire or electrical shock. Do not perform any repair work without consulting Yamato.

 Never use explosive or flammable substances or substances that include explosive or flammable ingredients. Explosion or fire may occur. (Refer to page 45 "List of Dangerous Substances".)

CAUTION!

 Do not place any objects on this unit.

 During a thunderstorm, turn the power, circuit breaker and main power off immediately. Not following this procedure may result in fire or electrical shock.

 Be cautious when opening or closing the door.

 • Keep door closed during operation -- The heater will not function properly if the door is left opened during operation.
• Do not leave door ajar after operation. The heat from chamber may damage control panel or control devices.

 Do not use corrosive samples. Strong acids or samples similar may corrode even type 304 Stainless steel. The door gaskets made of silicone may also corrode by solvent such as alkaline, oil, halogen etc.

 Operating temperature range of this unit is +5 to 210°C. Never set the temperature beyond this range.

 The maximum shelf load is approximately 33 lbs./15 kg per shelf. When loading samples, place conservatively in chamber with adequate space between samples. Overloading may cause improper temperature control. For best temperature results, allow 30% or more space between samples.

Handling Precautions

- ⊘ Do not place samples directly on bottom plate. This will disturb the performance and furthermore, the internal temperature and will cause malfunctions. Be sure to utilize the shelves provided.

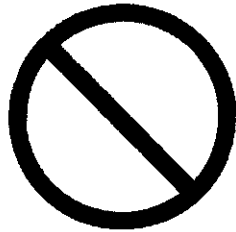

**Samples
on bottom chamber**

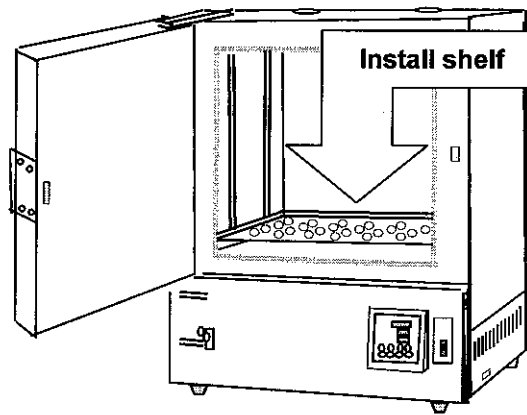

- ⚠ When power is restored after a power failure, the device automatically starts operation where it had left off. As a safety precaution, monitor your run after a power failure. We recommend that the unit be turned off after a power failure.

- ⚠ Do not stack chambers directly on top of each other.
An optional stacking kit is available for stacking units.
- ⊘ Contact Yamato or your sales representative for further details.

Daily Inspection and Maintenance

As a safety precaution, please perform the following daily inspection and maintenance procedures. Using tap water on this unit may attract dirt.

WARNING!

- Disconnect the power cord from the power source when inspecting or maintaining this unit.
- Perform daily inspections and maintenances after returning the temperature of this unit to standard.
- Do not disassemble this unit.

CAUTION!

- Use a damp soft cloth to wipe the unit clean. Do not use benzene, thinner or cleanser. Do not scrub this unit. Using such substances may result in deformation, deterioration or color change.

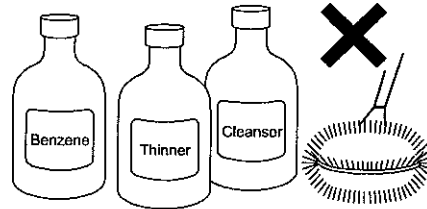

Please contact Yamato Scientific or your local sales representative with any questions or concerns you may have at 1-800-2-YAMATO (1-800-292-6286).

CAUTION!

Long-term storage

- Turn the power off and disconnect the power cord.

WARNING!

Disposing

- Keep out of reach of children.
- Remove the door and driving parts.

Consideration for Environmental Protection

We suggest that you to disassemble this unit as much as possible and recycle the reusable parts for environmental protection purposes. The feature components and materials of this unit are as follows:

Component	Material
Exterior Parts	
Outer cover	Steel plate melamine resin coating
Furnace	Type 304 Stainless Steel
Heat insulation material	DKN400/600: Rock wool DKN810/910: Glass wool
Door packing	Foam silicon rubber
Plates	PET resin film
Electrical Parts	
Heater	Stainless steel pipe heater
Motor	Steel plate, Copper wire, resin coated wire and other
Circuit boards	Board, Condenser, Transformer and other
Power cord, Wiring	Synthetic rubber or resin coated wiring materials

Safety Devices and Error Codes

This unit has an automatic diagnosis function built in the controller along with safety devices independent of the controller. The table below explains cause and solution methods when the safety device operates.

Error Codes:

If an abnormal condition should occur, an error code appears and you are visually and audibly alarmed. Record the error code and turn the power off immediately.

Safety Device	Notify	Cause/Solution
Sensor trouble detection	"ALARM" lamp lights on, "Er.01" appears	<ul style="list-style-type: none"> Damaged or disconnected temperature sensor. Contact your service representative.
SSR short-circuit detection	"ALARM" lamp lights on, "Er.02" appears	<ul style="list-style-type: none"> Short-circuit in triac. Contact your service representative.
Heater disconnection detection	"ALARM" lamp lights on, "Er.03" appears	<ul style="list-style-type: none"> Disconnected heater. Contact your service representative.
Memory error	"ALARM" lamp lights on, "Er.15" appears	<ul style="list-style-type: none"> Failure in internal memory. Contact your service representative.
Internal communication error	"ALARM" lamp lights on, "Er.17" appears	<ul style="list-style-type: none"> Failure in internal communication or temperature inputting circuit. Contact your service representative.
Overheat	"ALARM" lamp lights on, "Er.19" appears	<ul style="list-style-type: none"> Overheat prevention device is in operation. Reset the power supply, and then adjust the set temperature of the overheat protection device. Contact your service representative.
Measured temperature error	"ALARM" lamp lights on, "-----" appears	<ul style="list-style-type: none"> Measured value out of display range. Contact your service representative.

Condition	Probable Cause(s)
The device does not start when turning on the power.	<ul style="list-style-type: none">• Power plug is not connected to the receptacle correctly.• Power failure.
Temperature fluctuates during operation.	<ul style="list-style-type: none">• Overload of samples.• Air conditioner directly blowing on unit.• Fluctuation of ambient temperature.• Samples are too moist.• Power supply voltage is lower than proper value.

Should you receive any errors other than the ones listed above, turn power and primary power source off immediately. Immediately contact Yamato at 1-800-2-YAMATO (1-800-292-6286).

Request for Repair

Should you experience any difficulties, stop operation, turn power switch off, unplug the power plug, and contact Yamato Scientific America's Service Department.

< Please have the following information readily available >

- ◆ Product Model Number
 - ◆ Serial Number
 - ◆ Date of Purchase
 - ◆ Detailed Troubles
- } Refer to the serial number plate attached to unit.

Minimum Retention Period of Parts

The minimum retention period of parts for repair of this unit is 5 years after discontinuance of this unit.

Specifications

	DKN400	DKN600	DKN810	DKN910
Method	Forced Air Circulation			
Temperature control range	Ambient +5°C ~ 260°C			Ambient +5°C ~ 210°C
	Ambient temp.: 23°C, No load			
Temperature adjustment accuracy	±1°C (Set temp.: 210°C)			
Temperature distribution accuracy	±2.5°C (Set temp.: 210°C)			
Temperature rise time	(Room temp. to 260°C)			(Room temp. to 210°C)
	Approx. 60 min.	Approx.75 min.		
Temperature fall time	(260 to 50°C)			(210 to 50°C)
	Approx. 150 min.	Approx.160 min.	Approx.220 min.	
Heater	SUS pipe heater			
	1.2kw	1.5kw	3kw	3.6kw
Controller	HITEC® VS4			
Temperature control system	PID control for heater output by microprocessor			
Setting system	Digital			
Operation mode	Fixed temperature, Quick auto stop, Auto stop, Auto start, Program operation			
Sensor	K-thermocouple			
Additional functions	Lock function, Auto recovery after power failure, Calibration offset			
Self-diagnostic functions	Failure of Sensor, heater, SSR, memory, internal communication, temperature input circuit, automatic overheat prevention device, independent overheat prevention device, measured temperature			
Safety device	Circuit breaker, Overheat prevention device			
External dimensions (W×D×H, inch)	21.7×21.3×30.9	27.6×25.2×34.8	28×25.6×63.7	46.5×25.6×66.3
External dimensions (W×D×H, mm)	550×540×785	700×640×885	710×651×1619	1180×651×1683
Internal dimensions (W×D×H, inch)	17.7×15.7×15.7	23.6×19.7×19.7	23.6×20.1×39.4	42.1×19.7×39.4
Internal dimensions (W×D×H, mm)	450×400×400	600×500×500	600×510×1000	1070×500×1000
Capacity	2.5 cu. ft. (72ℓ)	5.3 cu. ft. (150ℓ)	10.6 cu. ft. (300ℓ)	18.5 cu. ft. (535ℓ)
Door	Single door, silicone gasket			Double door
Power supply (50/60Hz)	115V AC single phase		220V AC single phase	
	12A	14A	14A	17A
Weight	Approx. 99.2 lbs (45 kg)	Approx. 141.1 lbs (64 kg)	Approx. 275.6 lbs (125 kg)	Approx. 419 lbs (190 kg)
Accessories	Shelf (maximum load: 33 lbs (15kg) per shelf)			
	2 Shelves		4 Shelves	8 Shelves
	Instruction Manual			

- ❖ The performance under the power supply condition of AC 115V and 220V are shown here.
- ❖ The usable ambient temperature of the unit is from 5°C to 35°C.
- ❖ The temperature fall time here shows the reference value.

DKN400/600

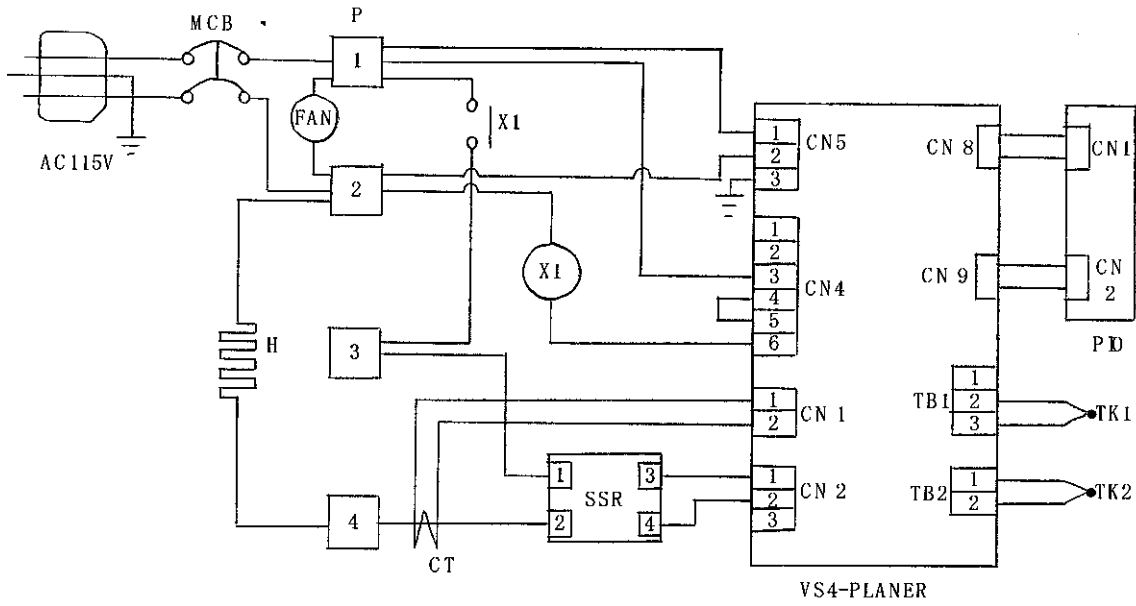

Symbol	Part name	Symbol	Part name
MCB	Circuit breaker	VS4-PLANAR	Control board
P	Terminal block	PIO	Display circuit board
H	Pipe Heater	TK1	Sensor for control
X1	Main Relay	TK2	Sensor for overheat prevention
FAN	Circulation Fan	CT	Current transformer
SSR	Breakerless relay		

DKN810

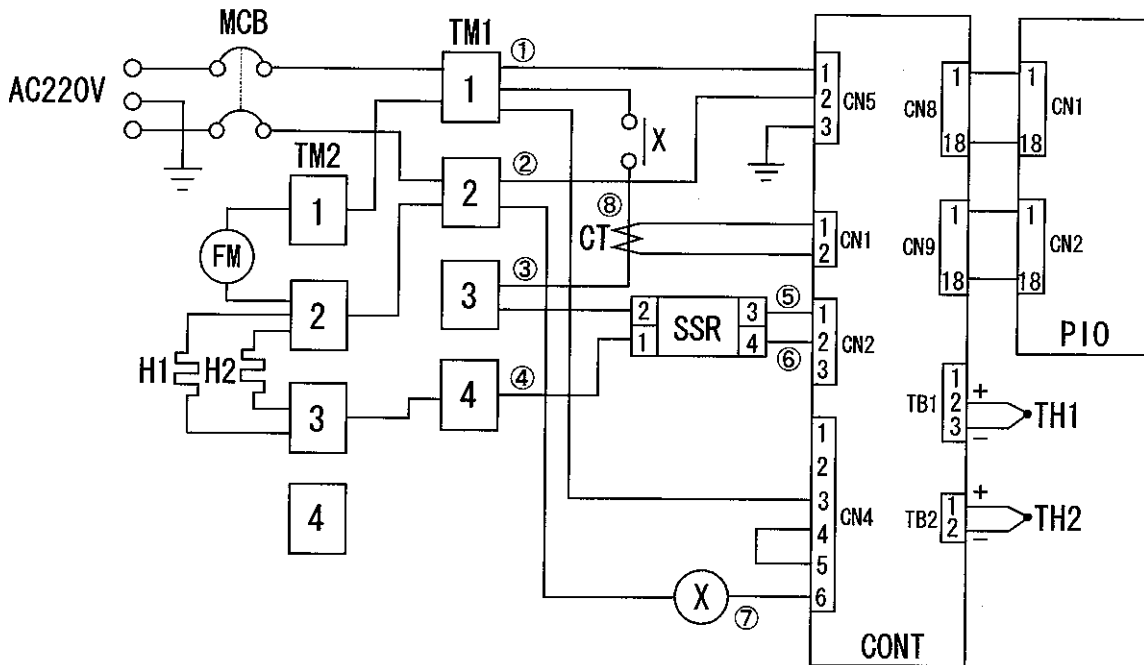

Symbol	Part name	Symbol	Part name
MCB	Circuit breaker	VS4-PLANAR	Control board
TM1/TM2	Terminal block	PIO	Display circuit board
H1/H2	Pipe Heater	TH1	Sensor for control
X	Main relay	TH2	Sensor for overheat prevention
FAN	Circulation fan	CT	Current transformer
SSR	Breakerless relay		

DKN900

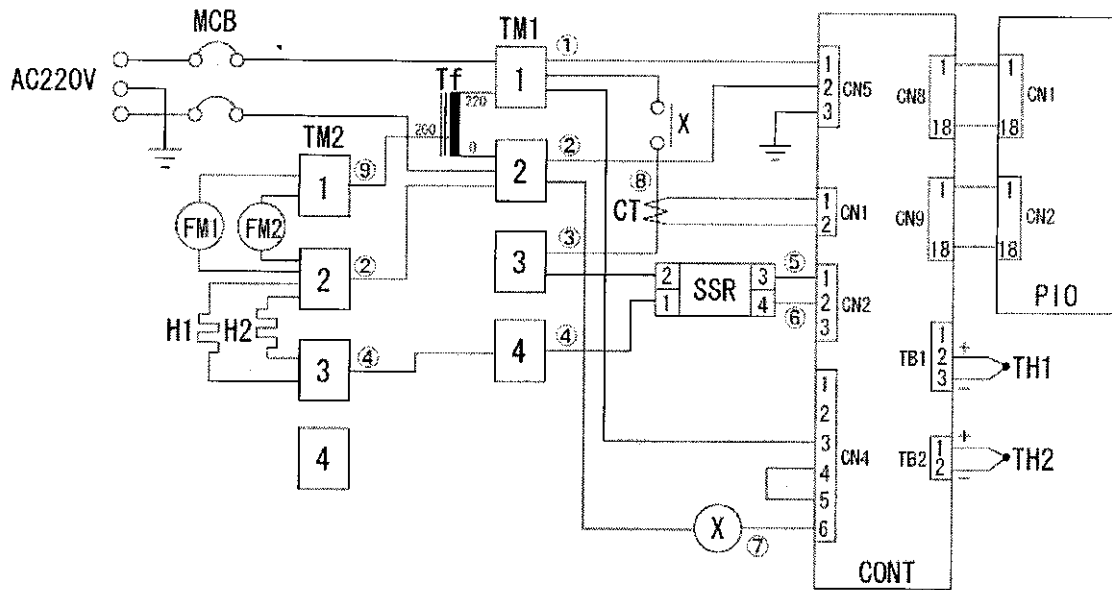

Symbol	Part name	Symbol	Part name
MCB	Circuit breaker	VS4-PLANAR	Control board
TM1/TM2	Terminal block	PIO	Display circuit board
H1/H2	Pipe Heater	TH1	Sensor for control
X	Main relay	TH2	Sensor for overheat prevention
FAN	Circulation fan	CT	Current transformer
SSR	Breakerless relay		

Replacement Parts List

DKN-400/600

Part Name		Specification	Code No.	Yamato P/N
Temperature control (TK1) and Overheat (TK2) Sensor		LCK-M 1 -2000-Y, K single	1160030049	DKN-100-N
CPU (Planar) board		VS4	1020000048	DKN-0057-N
Display board		VS4	1020000051	DKN-110-N
Display/Keypad interface ribbon cable		50mm	1130000009	DKN-122-N
Main power relay		AHE1254 120V	2050000019	DKN-103-N
Solid State Relay (SSR)		TRS5225	2160000035	DKN-A004-N
Power cord assembly		2.0sq 3p plug	2130010006	DKN-CORD-N
Main circuit breaker	DKN400	15A FB32B-15	2060000038	DKN-400-002-N
	DKN600	20A FB32B-20	2060000039	DKN-600-002-N
Current transformer (CT)		CTL-6-S-H	2170010005	DKN-106-N
Circulation motor		IC8422YAMA 115V 10W	2140000031	DKN-006-N
Heater	DKN400	SUS pipe heater 1.2KW	DK43S40160	DKN-400-002-N
	DKN600	SUS pipe heater 1.5KW	DK63S40290	DKN-600-002-N
Terminal connector		4 PIN		DKN-115-N
Door handle assembly		Type 304 Stainless Steel		DKN-013-N
Door latch	DKN400	Type 304 Stainless Steel		DKN-400-012-N
	DKN600	Type 304 Stainless Steel		DKN-600-012-N
Window gasket		Silicone		DKN-003-N
Door gasket	DKN400	Silicone		DKN-400-004-N
	DKN600			DKN-600-004-N
Rubber feet				OV-FEET-N
Keypad panel sheet		VS4		VS4-2283-N
Shelf	DKN400	Type 304 Stainless Steel		DKN-400-903-N
	DKN600			DKN-600-903-N
Shelf brackets	DKN400	Type 304 Stainless Steel		DKN-400-009-N
	DKN600			DKN-600-009-N

Replacement Parts List

DKN-810/900

Part Name		Specification	Code No.	Yamato P/N
Temperature control (TK1) and Overheat (TK2) Sensor		LCK-M 1 -2000-Y, K single	1160030049	DKN-100-N
CPU (Planar) board		VS4	1020000048	DKN-0057-N
Display board		VS4	1020000051	DKN-110-N
Display/Keypad interface ribbon cable		50mm	1130000009	DKN-122-N
Main power relay		AHE1255 220V	2050000044	DKN-104-N
Solid State Relay (SSR)		TRS5225	2160000035	DKN-A004-N
Power cord assembly	DKN810	2.0sq 3p	DN105	DKN-CORD2-N
	DKN900	3.5sq 3p	2130010010	DKN-CORD3-N
Main Circuit breaker	DKN810	15A FB32B-15	2060000038	DKN-400-002-N
	DKN900	20A FB32B-20	2060000039	DKN-600-002-N
Current Transformer (CT)		CTL-6-S-H	2170010005	DKN-106-N
Circulation motor	DKN810	IC8434YAMAB 220V 30W	2140000036	DKN-0061-N
	DKN900	IC8422YAMAB 220V 10W	2140000033	DKN-0062-N
Heater	DKN810	SUS pipe heater 1.2KW × 2	DK81030320	DKN-810-002-N
	DKN900	SUS pipe heater 1.5KW × 2	DN93S30220	DKN-900-002-N
Terminal Connector		4 PIN	2070230001	DKN-1151-N
Door handle assembly		Type 304 Stainless Steel		DKN-013-N
Door latch	DKN810	Type 304 Stainless Steel	DN933	DKN-810-012-N
	DKN900	Type 304 Stainless Steel	DN939	DKN-900-012-N
Window gasket		Silicone		DKN-0131-N
Door gasket		Silicone	DN100	DKN-810-004-N
Keypad panel sheet		VS4	9300000236	DKN-2283-N
Shelf	DKN810	Type 304 Stainless Steel		DKN-810-903-N
	DKN900	Type 304 Stainless Steel		DKN-900-903-N
Shelf brackets	DKN810	Type 304 Stainless Steel		DKN-810-009-N
	DKN900	Type 304 Stainless Steel		DKN-900-009-N

List of Dangerous Substances



Never use explosive or flammable substances, or substances that include explosive or flammable ingredients.

EXPLOSIVE

EXPLOSIVE:	Ethylene glycol dinitrate (nitro glycol), Glycerin trinitrate (nitroglycerine), Cellulose nitrate (nitrocellulose), and other explosive nitrate esters
	Trinitrobenzene, Trinitrotoluene, Trinitrophenol (picric acid), and other explosive nitro compounds
	Acetyl hidroperoxide (peracetic acid), Methyl ethyl ketone peroxide, Benzyl peroxide, and other organic peroxides

FLAMMABLE

IGNITING:	Lithium (metal), Potassium (metal), Sodium (metal), Yellow phosphorus, Phosphorus sulfide, Red phosphorus, Celluloid compounds, Calcium carbide, Lime phosphate, Magnesium (powder), Aluminum (powder), Powder of metals other than magnesium and aluminum, Sodium hydrosulfite
OXIDIZING:	Potassium chlorate, Sodium chlorate, Ammonium chlorate, and other chlorate
	Potassium perchlorate, Sodium perchlorate, Ammonium perchlorate, and other perchlorate
	Potassium peroxide, Sodium peroxide, Barium peroxide, and other inorganic peroxide
	Potassium nitrate, Sodium nitrate, Ammonium nitrate, and other nitrate
	Sodium chlorite and other chlorites
	Calcium hypochlorite and other hypochlorites
INFLAMMABLE LIQUID:	Ethyl ether, Gasoline, Acetaldehyde, Propylene chloride, Carbon disulfide, and other flammable substances having a flash point of lower than -30°C
	Normal hexane, ethylene oxide, acetone, benzene, methyl ethyl ketone, and other flammable substances having a flash point of -30°C or higher but lower than 0°C
	Methanol, Ethanol, Xylene, Pentyl acetate (amyl acetate), and other flammable substances having a flash point of 0°C or higher but lower than 30°C
	Kerosene, Light oil (gas oil), Oil of turpentine, Isopentyl alcohol (isoamyl alcohol), Acetic acid, and other flammable substances having a flash point of 30°C or higher but lower than 65°C
FLAMMABLE GAS:	Hydrogen, Acetylene, Ethylene, Methane, Propane, Butane, and other flammable substances which assume a gaseous state at 15°C and 1 atm

(Source: Appendix Table 1 of Article 6 of the Industrial Safety and Health Order in Japan)

Responsibility

Please follow the instructions in this document when using this unit. Yamato Scientific has no responsibility for the accidents or breakdown of device if it is used with a failure to comply. Never conduct what this document forbids. Unexpected accidents or breakdown may result in.

Note

- ◆ The contents of this document may be changed in future without notice.
- ◆ Any books with missing pages or disorderly binding may be replaced.

Instruction Manual for
MECHANICAL CONVECTION OVENS
Model DKN400/600/810/900
First Edition Feb. 13, 2006

Yamato Scientific America, Inc.
925 Santa Clara, Walsh Avenue,
TCA 95050, U.S.A
<http://www.yamato-usa.com>