



Instruction Manual  
Mini Shaker  
Microplate Shaker



## TABLE OF CONTENTS

Package Contents	1
Warranty	1
Installation	2
Maintenance & Servicing	2
Environmental Conditions	2
Safety Instructions	3
Standards & Regulations	3
Control Panel	4
Mini Shaker	5-6
Microplate Shaker	7-8
Operating Instructions	9-10
Troubleshooting	10
Replacement Parts	11-12
Accessories	13-14

### PACKAGE CONTENTS

Mini Shaker or Microplate Shaker  
Non-skid rubber mat (Mini Shaker only)  
92" (234cm) detachable power cord  
Instruction manual

### WARRANTY

Manufacturer warrants this product to be free from defects in material and workmanship when used under normal conditions for five (5) years. Register your equipment or instrument online at [www.vwrsp.com/warranty](http://www.vwrsp.com/warranty) for US residents or [www.vwrcanlab.com/warranty](http://www.vwrcanlab.com/warranty) for Canadian residents. For your reference, make a note of the serial number, date of purchase and supplier here.

Serial No.: \_\_\_\_\_ Date of Purchase: \_\_\_\_\_

Supplier: \_\_\_\_\_

## **INSTALLATION**

---

Upon receiving the VWR Mini/Microplate Shaker, check to ensure that no damage has occurred during shipment. It is important that any damage that occurred in transport is detected at the time of unpacking. If you do find such damage the carrier must be notified immediately.

After unpacking, place the Mini/Microplate Shaker on a level bench or table, away from explosive vapors. Secure to an immovable work surface by pressing down on the four (4) corners of the unit, creating a strong suction to the work surface (**DO NOT** place on a bench mat). Ensure that the surface on which the unit is placed will withstand typical heat produced by the unit. Always place the unit on a sturdy work surface.

The Mini/Microplate Shaker is supplied with a power cord that is inserted into the IEC connector on the back of the unit first, then it can be plugged into a properly grounded outlet. The 120V unit plugs into a 120 volt, 50/60 Hz source. The 230V unit plugs into a 230 volt, 50/60 Hz source.

## **MAINTENANCE & SERVICING**

---

The Mini/Microplate Shaker is built for long, trouble-free, dependable service. No lubrication or other technical user maintenance is required. However at least every three (3) months you should:

- Unplug the unit.
- Remove any accumulated dirt from the base and tray.
- Check all accessible items to make sure they are properly tightened.

The unit should be given the care normally required for any electrical appliance. Avoid wetting or unnecessary exposure to fumes. Spills should be removed promptly. **DO NOT** use a cleaning agent or solvent on the front panel which is abrasive or harmful to plastics, nor one which is flammable. Always ensure the power is disconnected from the unit prior to any cleaning. If the unit ever requires service, contact your VWR representative.

## **ENVIRONMENTAL CONDITIONS**

---

**Operating Conditions:** Indoor use only.

\* For use in CO<sub>2</sub> environments, incubators or cold rooms.

\* Temperature: -10 to 60°C (14 to 140°F).

Humidity: maximum 80% relative humidity, non-condensing

Altitude: 0 to 6,562 ft (2000 M) above sea level

**Non-Operating Storage:**

\* Temperature: -20 to 65°C (-4 to 149°F)

Humidity: maximum 80% relative humidity, non-condensing

Installation Category II and Pollution Degree 2 in accordance with IEC 664.

\* **Avoid cold starts:** Unit is not designed to start after being in a cold room environment. Bring unit into cold room from a room temperature environment, operate and remove unit from cold room as soon as operation is complete.

## SAFETY INSTRUCTIONS

---

Please read the entire instruction manual before operating the Mini/Microplate Shaker.



**WARNING! DO NOT** use the Mini/Microplate Shaker in a hazardous atmosphere or with hazardous materials for which the unit was not designed. Also, the user should be aware that the protection provided by the equipment may be impaired if used with accessories not provided or recommended by the manufacturer, or used in a manner not specified by the manufacturer.

Always operate unit on a level surface for best performance and maximum safety.

**DO NOT** lift unit by the tray.



**CAUTION!** To avoid electrical shock, completely cut off power to the unit by disconnecting the power cord from the unit or unplug from the wall outlet. Disconnect unit from the power supply prior to maintenance and servicing.

Spills should be removed promptly. **DO NOT** immerse the unit for cleaning.

**DO NOT** operate the unit if it shows signs of electrical or mechanical damage.



Earth Ground - Protective Conductor Terminal



Alternating Current

## STANDARDS & REGULATIONS

---

Troemner, LLC hereby declares under its sole responsibility that the construction of this product conforms in accordance with the following standards:

### Safety standards:

IEC 61010-1 Safety requirements for electrical equipment for measurement, control and laboratory use. Part I: General Requirements.

IEC 61010-2-051 Part II: Particular requirements for laboratory equipment for mixing and stirring.

UL Std. No. 61010-1

CSA/CAN C22.2 No. 0-M91

CSA/CAN C22.2 No. 61010-1-04

### EMC standards:

FCC-B

EN55022-B

EN6100-3-3

EN6100-4-5

EN61000-4-2

EN61000-4-3

EN61000-4-4

EN61000-4-6

EN61000-4-11

EN61326-1 Class A

### Associated EU guidelines:

EMC directive 2004/108/EC

RoHS directive 2011/65/EU

LVD directive 2006/95/EC

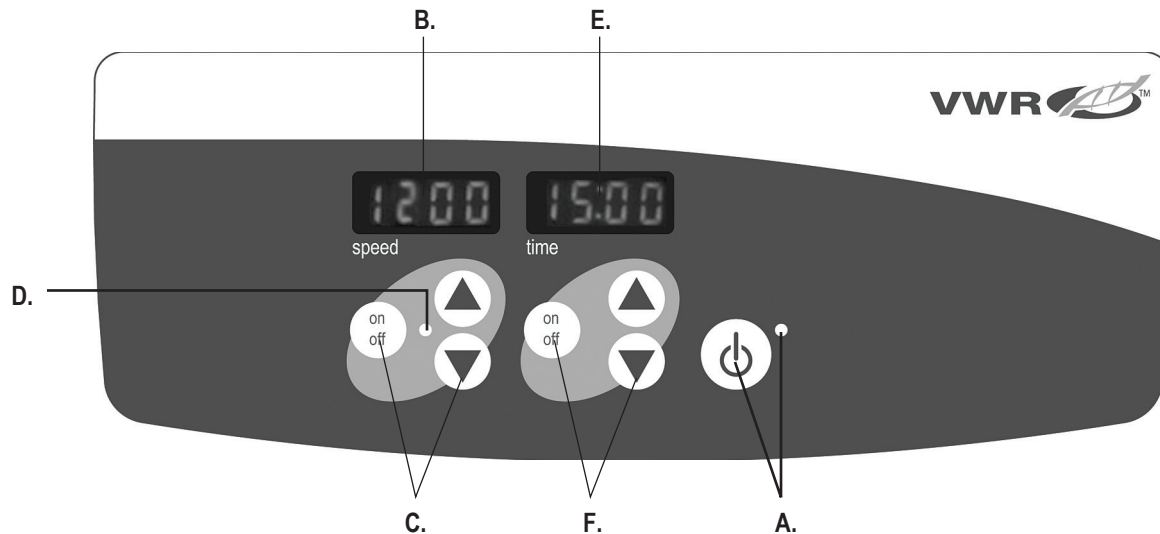

## CONTROL PANEL

The front panel of the Mini/Microplate Shaker contains all the controls and displays needed to operate the unit.

**A. Standby button/standby indicator light:** The standby indicator light will illuminate when the unit is plugged in. The unit will be in standby mode. Press the standby button to activate the speed and time functions. The standby indicator light will shut off and the speed display and time displays will illuminate. Press the standby button again and the unit will once again be in standby mode.

**B. Speed display:** Displays the speed of the shaker. **C.** Up/down arrows for set-point control. **D.** On/off button starts/stops shaking function. **D.** The speed indicator light will be illuminated when the unit is shaking.

**E. Time display:** Displays accumulated time (continuous mode) or how much time is remaining (timed mode). The display range is from 0 to 9,999 minutes in one (1) second increments. The display will indicate minutes and seconds until the timer reaches 99 minutes and 59 seconds (99:59), then the display will automatically display minutes up to 9,999. **F.** Up/down arrows for set-point control. **F.** On/off button starts/stops the time function.

## MINI SHAKER SPECIFICATIONS



<b>Overall dimensions (L x W x H):</b>	17 x 11 x 4" (43.2 x 27.9 x 10.2cm)
<b>Tray dimensions (L x W):</b>	11.75 x 8.75" (29.9 x 22.2cm)
<b>Electrical (50/60 Hz):</b>	120 volts, 5 amps, 25 watts 230 volts, 5 amps, 25 watts
<b>Fuses:</b>	5mm x 20mm, 5 amp quick acting
<b>Speed range:</b>	100 to 1200rpm
<b>Speed accuracy:</b>	±2%
<b>Timer:</b>	1 second to 9999 minutes (increased in 1 second increments)
<b>Orbit:</b>	0.125" (3mm)
<b>Maximum weight capacity:</b>	~ 8lbs (3.6kg), up to 1000rpm ~ 5lbs (2.3kg), over 1000rpm
<b>Controls:</b>	see page 4
<b>Tray material:</b>	aluminum
<b>Ship weight:</b>	25lbs (11.4kg)

*Mini Shaker with plasticware*

## MINI SHAKER SET-UP

The Mini Shaker is supplied with a tray designed to hold a variety of accessories.

1. Flat containers can be shaken by placing them on the non-skid mat provided with the unit.
2. The tray also has mounting holes ready for use with flask/media bottle clamps or test tube racks. See below for tray configurations.

## MINI SHAKER TRAY CONFIGURATIONS

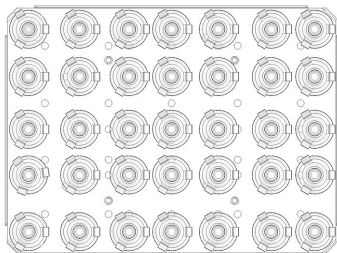

(35) 10mL Erlenmeyer Flask Clamps

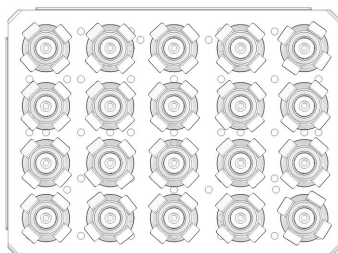

(20) 25mL Erlenmeyer Flask Clamps

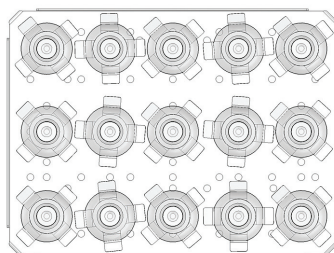

(15) 50mL Erlenmeyer Flask Clamps

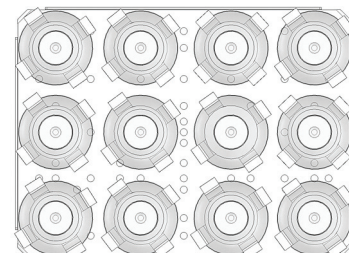

(12) 125mL Erlenmeyer Flask Clamps

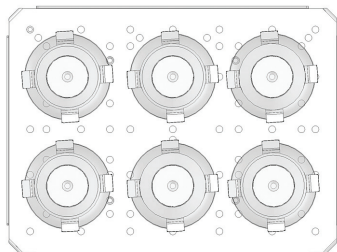

(6) 250mL Erlenmeyer Flask Clamps

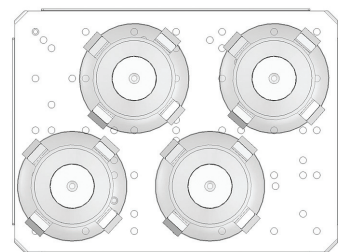

(4) 500mL Erlenmeyer Flask Clamps

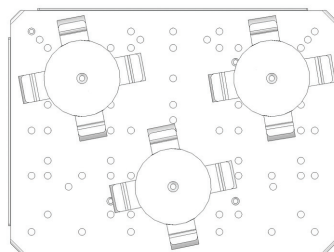

(3) 500mL Media Bottle Clamps

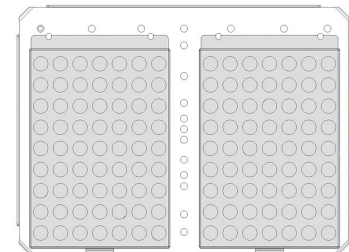

(2) Test Tube Racks

## MICROPLATE SHAKER SPECIFICATIONS

---



<b>Overall dimensions (L x W x H):</b>	17 x 11 x 4" (43.2 x 27.9 x 10.2cm)
<b>Tray dimensions (L x W):</b>	11 x 7.75" (27.9 x 19.7cm)
<b>Electrical (50/60 Hz):</b>	120 volts, 5 amps, 25 watts 230 volts, 5 amps, 25 watts
<b>Fuses:</b>	5mm x 20mm, 5 amp quick acting
<b>Speed range:</b>	100 to 1200rpm
<b>Speed accuracy:</b>	±2%
<b>Timer:</b>	1 second to 9999 minutes (increased in 1 second increments)
<b>Orbit:</b>	0.125" (3mm)
<b>Capacity:</b>	4 microplates or 2 Micro-Tube Racks
<b>Controls:</b>	see page 4
<b>Tray material:</b>	aluminum
<b>Ship weight:</b>	25lbs (11.4kg)

*Microplate Shaker with plasticware and 1.5 to 2mL Micro-Tube Rack*



## MICROPLATE SHAKER SET-UP

The Microplate Shaker is designed to hold two (2) or four (4) microplates, or two (2) Micro-Tube Racks.

1. Place two (2) microplates or deep well blocks diagonally on the tray, or place four (4) microplates or deep well blocks on the tray. The plates/blocks do not have to be filled.
2. Place the corner of the plate/block under the spring located at each corner of the tray.
3. Slide plate/block into place. You are ready to use.

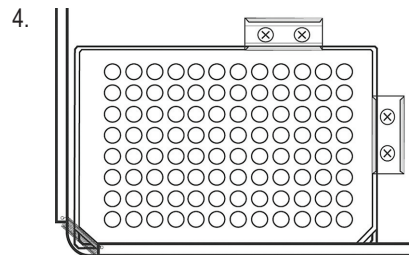
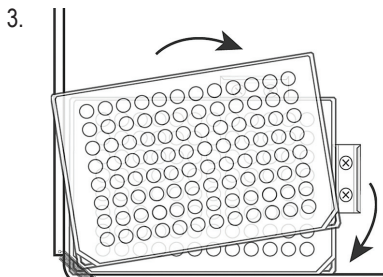
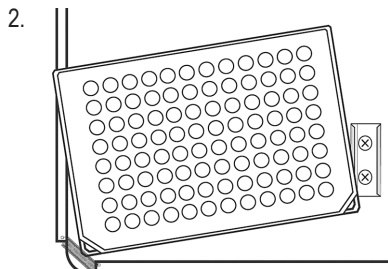

## MICROPLATE SHAKER TRAY CONFIGURATIONS

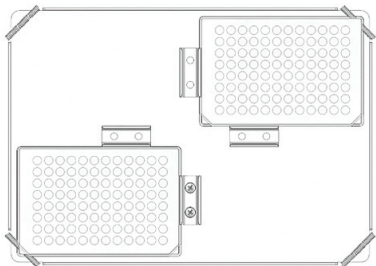

(2) microplates

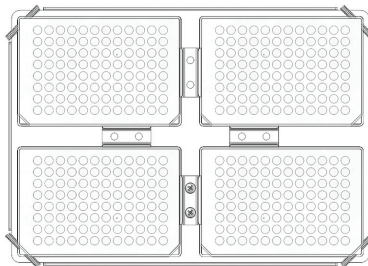

(4) microplates

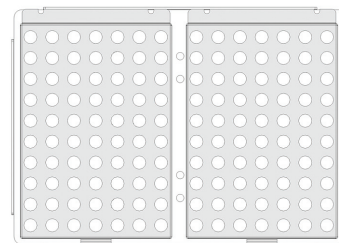

(2) Micro-Tube Racks

**NOTE:** The tray on the Microplate Shaker is not designed to hold flask clamps.

## OPERATING INSTRUCTIONS

---

The Mini/Microplate Shakers have been designed for the speed and time functions to work independently of one another. The speed can be reset without resetting the timer and the timer can be stopped and started without interrupting the shaking function.

### 1. Getting ready:

- a. Plug the power cord into a properly grounded outlet. The standby indicator light will illuminate, verifying power to the unit.
- b. Press the standby button to move the unit from standby mode. The standby indicator light will turn off and the speed and time displays will illuminate, displaying the previously used settings.



### 2. Setting speed:

- a. Press the up/down arrows below the speed display until you reach the desired speed. When you release the button, the display will blink off and then on indicating the new set speed has been accepted.
- b. Press the on/off button to start the shaking function. The indicator light below the speed display will illuminate to indicate the shaking function is in use and remain lit until shaking has ceased. The microprocessor controlled ramping feature slowly increases speed until the set-point is reached which helps to avoid splashing, and provides excellent low end control.
- c. Speed adjustments can be made without interrupting shaking by using the up/down arrows below the speed display. After the change has been made and you release the button, the display will blink off and then on indicating the new set speed has been accepted.
- d. To stop the shaking function, press the on/off button below the speed display. The speed indicator light will turn off.

3. **Setting time to zero (0:00) and continuous mode:** Accumulated time.
  - a. Press and hold the on/off button below the time display. After three (3) seconds the display will indicate the previous set time.
  - b. Simultaneously press both the up and the down arrows, the display will indicate zero (0:00). The unit time is now set to zero (0:00) minutes. Alternately, you can use the up/down arrows to get to zero (0:00).
  - c. Press the on/off button below the time display. The display will indicate accumulated time. The up/down arrows will become inactive. To stop timer, press the on/off button again. **IMPORTANT:** This will **NOT** interrupt the shaking function. Press the on/off button below the speed display to interrupt the shaking function.
  - d. To reset, press and hold the on/off button below the time display. After three (3) seconds the display will indicate the previous set time, which was zero (0:00).
4. **Setting timed mode:** Programmed time.
  - a. Press the up/down arrows below the time display until you reach the desired time.
  - b. Start this function by pressing the on/off button below the time display. The unit will run for the selected time, the up/down arrows will become inactive while the timer is running. The unit will stop shaking when time display reaches zero (0:00). Four (4) audible beeps will indicate the count down function is complete. The time display will default back to the set time. To repeat for the same time, simply press the on/off button again.

## OPERATING INSTRUCTIONS

---

c. To interrupt an automatic timing cycle before it is completed, press the on/off button below the time display. The display will flash off and on to indicate the time function is on "hold". **IMPORTANT:** This will **NOT** interrupt the shaking function. Press the on/off button below the speed display to interrupt the shaking function. Restart the timer by pressing the on/off button below the time display. Unit will continue counting down to zero (0:00). When the display reaches zero (0:00), you will hear the four (4) audible beeps that indicate the count down function is complete and the shaking function will cease.

### 5. Turning unit off:

a. To turn the unit off, press the standby button. The speed and time displays will be blank, the standby indicator light will illuminate. The Mini/Microplate Shaker should be kept in standby mode when not in use. To completely cut off power to the unit, disconnect the power cord from the unit or unplug from the wall outlet.

## OPERATING TIPS

As a safety feature, a built-in program will shut power off to the motor if the tray is prevented from rotating, or the unit is overloaded beyond its recommended weight capacity.

Built-in memory maintains the last used speed and time settings during a power interruption.

## TROUBLESHOOTING

---

During operation, any rattling or ticking sounds may indicate a loose screw on the tray, a tray attachment or an accessory. All accessories should be sufficiently tightened in place before starting the unit.

<u>Error Code</u>	<u>Software Test</u>	<u>Cause</u>
E04	unit overloaded	maximum load exceeded loose foot (suction cup) *

Press the standby button to clear this error. Be sure the load is within the maximum load capacity before restarting the unit. If the E04 error code persists, switch the unit off and contact your VWR representative for repairs.

<u>Error Code</u>	<u>Software Test</u>	<u>Cause</u>
E03	drive system failure	ceased bearing drive belt broken mechanical obstruction loose foot (suction cup) *

Press the standby button to clear this error and remove the mechanical obstruction. If the E03 error persists the reason may be a ceased bearing or broken drive belt and should **NOT** be addressed by the end user. Switch the unit off and contact your VWR representative for repairs.

\* In the event a foot (suction cup) has come loose from the bench top, the unit will register an errant E04 or E03 error message due to the instability of the unit. Press the standby button to clear this error. Firmly press down on the four (4) corners of the unit, creating a strong suction to the work surface (**DO NOT** place on bench mat). Press the standby button to resume operation.

## MINI SHAKER REPLACEMENT PARTS

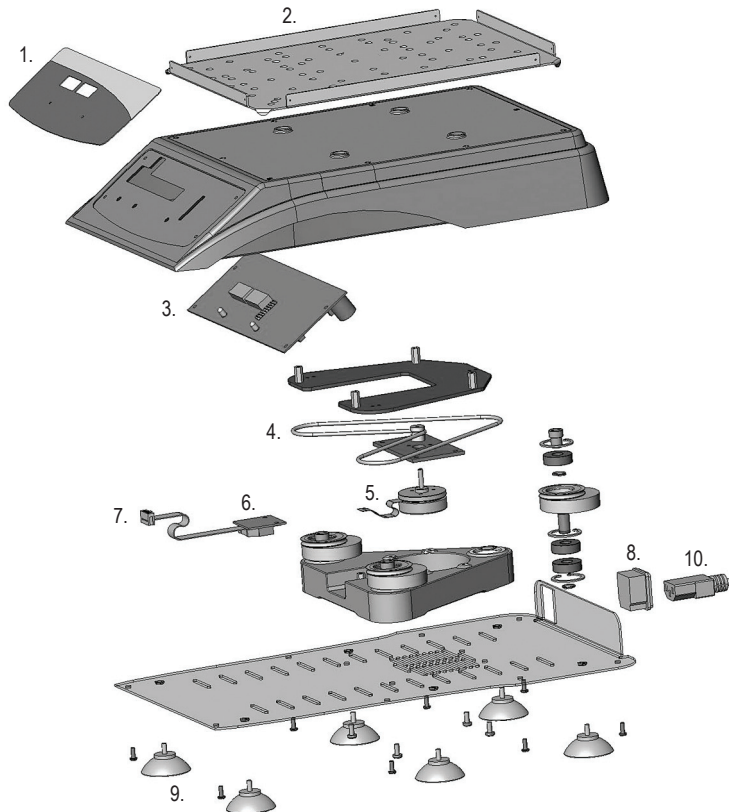

### DESCRIPTION

1. Front panel membrane switch
2. Tray
3. Display board
4. Belt
5. Motor
6. Motor transition board
7. Connection cable
8. IEC power entry module
9. Feet (suction cup)
10. Detachable 92" (234cm) power cord:

### PART NUMBER

	380704-00
	580050-00
	380780-00
	580019-00
	380712-00
	380715-00
	380720-00
	386122-00
	545014-00
120V	330100-00
EURO	330101-00
UK	330102-00
SWISS	330103-00

## MICROPLATE SHAKER REPLACEMENT PARTS

### DESCRIPTION

1. Front panel membrane switch
2. Tray assembly
3. Display board
4. Belt
5. Motor
6. Motor transition board
7. Connection cable
8. IEC power entry module
9. Feet (suction cup)
10. Detachable 92" (234cm) power cord:

120V  
EURO  
UK  
SWISS

### PART NUMBER

- 380703-00  
880761-00  
380780-00  
580019-00  
380712-00  
380715-00  
380720-00  
386122-00  
545014-00  
330100-00  
330101-00  
330102-00  
330103-00

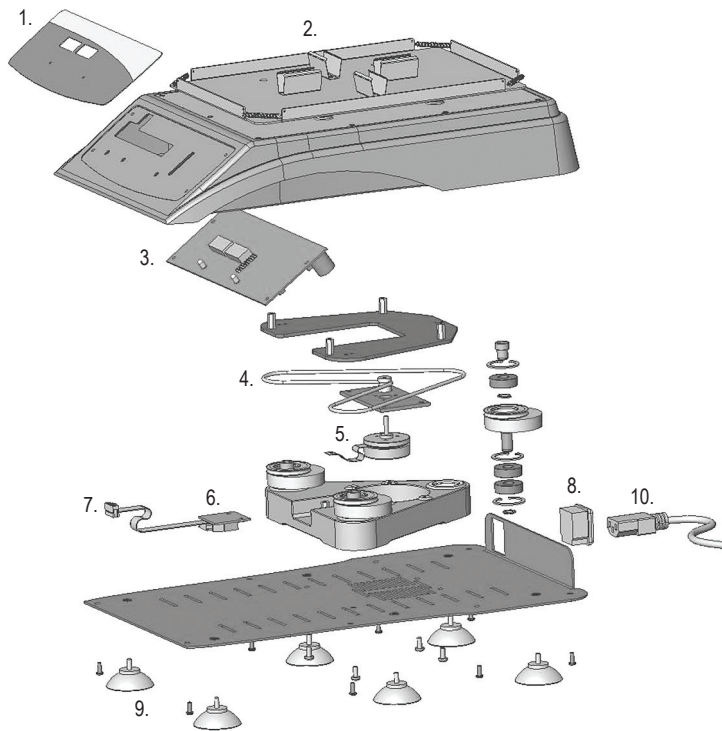

## ACCESSORIES

### TEST TUBE RACKS

DESCRIPTION	TUBE CAPACITY	PLATFORM CAPACITY	CAT. No.
10 to 13mm Test Tube Rack	63	2	12620-956
14 to 16mm Test Tube Rack	48	2	12620-958
18 to 20mm Test Tube Rack	35	2	12620-960
22 to 25mm Test Tube Rack	24	2	12620-962
15mL Centrifuge Tube Rack	35	2	11301-134
50mL Centrifuge Tube Rack	12	2	11301-136
1.5 to 2mL Micro-Tube Rack	70	2	12620-952

#### Installation of Test Tube Racks - Mini Shaker

1. Unit should be in standby mode.
2. Remove non-skid rubber mat.
3. Align the clip on the rack to the right side of the tray.
4. Line up the holes in the test tube rack to the holes in the tray. Using the screws provided, hand tighten into place using a flathead screwdriver. **DO NOT** over tighten.

#### Installation of 1.5 to 2mL Micro-Tube Rack - Microplate Shaker

1. Unit should be in standby mode.
2. Align the Micro-Tube Rack side-to-side on the tray.
3. Press the Micro-Tube Rack in place, you will hear the Micro-Tube Rack clip into position. No mounting screws are required.

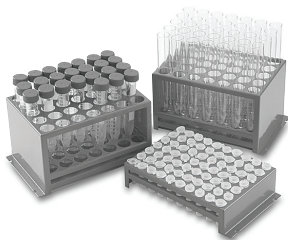

### FLASK CLAMPS

DESCRIPTION	MATERIAL	PLATFORM CAPACITY	CAT. No.
10mL Erlenmeyer Flask Clamp	stainless steel	35	57018-775
25mL Erlenmeyer Flask Clamp	stainless steel	20	57018-786
50mL Erlenmeyer Flask Clamp	stainless steel	15	57018-797
125mL Erlenmeyer Flask Clamp	stainless steel	12	57018-800
250mL Erlenmeyer Flask Clamp	stainless steel	6	57018-811
500mL Erlenmeyer Flask Clamp	stainless steel	4	57018-822
500mL Media Bottle Clamp	stainless steel	3	14215-236
125mL Erlenmeyer Flask Clamp	PVC	12	97003-576
250mL Erlenmeyer Flask Clamp	PVC	6	97003-578
500mL Erlenmeyer Flask Clamp	PVC	4	97003-580

#### Installation of Flask Clamps - Mini Shaker

1. Unit should be in standby mode.
2. Remove non-skid rubber mat.
3. Line up the hole(s) in the flask clamp to the hole(s) in the tray. Using the screw(s) provided, hand tighten into place using a flathead screwdriver. **DO NOT** over tighten.
4. Insert flask/media bottle into clamp and wrap the spring around the neck of the clamp to hold secure.

**Not for use with the Microplate Shaker.**



## ACCESSORIES

### UNIVERSAL HARNESS

DESCRIPTION	MICROPLATE CAPACITY	PLATFORM CAPACITY	CAT. No.
Universal Harness	2 or 4	1	12620-954

#### Installation of Universal Harness - Mini Shaker

1. Unit should be in standby mode.
2. Remove non-skid rubber mat.
3. Insert one band through the side of one "U" in the U-shaped cut-outs on the center post. Pull band through to secure to the U-shaped cut-out. Repeat for the three remaining bands.
4. After the bands are installed in the center post, line up the holes in center post with the two holes in middle of the tray. Using the screws provided, hand tighten into place using a flathead screwdriver. **DO NOT** over tighten.
5. Place sample(s) on tray.
6. Stretch the harness bands over the sample(s) and then under each of the bent-down corners of the tray.

**Not for use with the Microplate Shaker.**

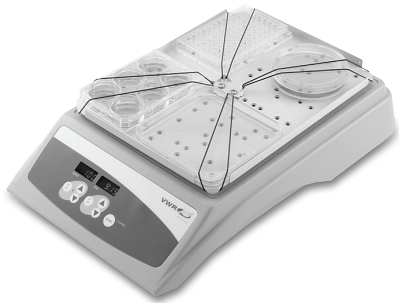

### UNIVERSAL PLATFORM

The Universal Platform has a non-skid rubber surface with adjustable clamping bars to accommodate various vessel types. Stainless steel construction.

DESCRIPTION	SIZE (L x W)	PLATFORM CAPACITY	CAT. No.
Universal Platform	11.7 x 8.7" (29.7 x 22.1cm)	1	12620-964

#### Installation of Universal Platform - Mini Shaker

1. Unit should be in standby mode.
2. Remove non-skid rubber mat.
3. Line up the holes in the Universal Platform to the holes in the tray. Using the screws provided, hand tighten into place using a flathead screwdriver. **DO NOT** over tighten.
4. Add glassware. Adjust rollers by loosening each of the thumbscrews. Slide the padded rollers to the desired position and retighten the thumbscrews.

**Not for use with the Microplate Shaker.**



---

MANUFACTURED BY:

**TROEMNER LLC**

201 Wolf Drive • PO Box 87 • Thorofare, NJ 08086-0087  
Phone: 856-686-1600 • Fax: 856-686-1601 • E-mail: [troemner@troemner.com](mailto:troemner@troemner.com)  
[www.troemner.com](http://www.troemner.com)

715054-00 (REV 7 - 8/16)