

Digital Shaking Drybath

Orbital Motion, 120 or 230V AC, 60 or 50/60Hz

Catalog #88880027 & 88880028

Operation Manual 9240-11-019

Thermo
SCIENTIFIC



Important Before using this product, read this entire operation manual carefully. Users should follow all of the operational guidelines contained in this manual and take all necessary safety precautions while using this product. Failure to follow these guidelines could result in potentially irreparable bodily harm and/or property damage. ▲

Caution All internal adjustments and maintenance must be performed by qualified service personnel. ▲

Material in this manual is for information purposes only. Thermo Fisher Scientific is committed to a continuing program of product development and improvement, and reserves the right to change information, such as specifications, appearance, and dimensions, described in this document without notice. Thermo makes no representations or warranties with respect to this manual. In no event shall Thermo be held liable for any damages, direct or incidental, arising out of or related to the use of this manual.

No part of this manual may be reproduced or transmitted in any form or by any means, including photocopying, recording, or using information storage and retrieval systems, for any purpose other than the purchaser's own use, without the express written permission of the manufacturer.

Any other product names and services identified in this manual are trademarks or registered trademarks of their respective owners. No such use, or the use of any trade name, is intended to convey endorsement or other affiliation with Thermo Fisher Scientific.





©2013 Thermo Fisher Scientific. All rights reserved.

MANUAL NUMBER 9240-11-019

0	--	11/12/13	Original	CCS
REV	ECR/ECN	DATE	DESCRIPTION	By

This manual contains important safety and operation information. You must carefully read, understand, and follow all the instructions in this manual prior to operating this instrument. Keep this manual in a safe place nearby for reference and make it easily available to all users.

- 1) This manual highlights DANGER/WARNING/CAUTION/NOTICE alerts to prevent injury or property damage and also to achieve optimum performance of your instrument.
- 2) These alerts are classified into four types in this manual depending on the importance and the risk levels as described below:

Symbols	Meaning
	Indicates a hazardous situation which, if not avoided, will result in death or serious injury.
	Ignoring this warning could cause serious injury or even death.
	Ignoring this caution could cause injury or property damage.
	Ignoring this notice could cause operational problems.

- 3) The claim which is out of the quality guarantee published by the Manufacturer is out of Manufacturer's responsibility.
- 4) The damage which is from unexpected fault or damage of user by Acts of God is out of Manufacturer's responsibility.

Do You Need Information or Assistance on Thermo Scientific Products?

If you do, please contact us 8:00 a.m. to 6:00 p.m. (Eastern Time) at :

1-740-373-4763

1-800-438-4851

<http://www.thermoscientific.com>

service.led.marietta@thermofisher.com

service.led.marietta@thermofisher.com

www.unitylabservices.com

Direct

Toll Free, U.S. and Canada

FAX

Internet Worldwide Web Home Page

Tech Support Email Address

Certified Service Web Page

Our **Sales Support** staff can provide information on pricing and give you quotations. We can take your order and provide delivery information on major equipment items or make arrangements to have your local sales representative contact you. Our products are listed on the Internet and we can be contacted through our Internet home page.

Our **Service Support** staff can supply technical information about proper setup, operation or troubleshooting of your equipment. We can fill your needs for spare or replacement parts or provide you with on-site service. We can also provide you with a quotation on our Extended Warranty for your Thermo Scientific products.

Whatever Thermo Scientific products you need or use, we will be happy to discuss your applications. If you are experiencing technical problems, working together, we will help you locate the problem and, chances are, correct it yourself...over the telephone without a service call.

When more extensive service is necessary, we will assist you with direct factory trained technicians or a qualified service organization for on-the-spot repair. If your service need is covered by the warranty, we will arrange for the unit to be repaired at our expense and to your satisfaction.

Regardless of your needs, our professional telephone technicians are available to assist you Monday through Friday from 8:00 a.m. to 6:00 p.m. Eastern Time. Please contact us by telephone or fax. If you wish to write, our mailing address is:

Thermo Fisher Scientific
401 Millcreek Road, Box 649
Marietta, OH 45750

International customers, please contact your local Thermo Scientific distributor.

Table of Contents

Section 1	Warnings and Cautions -----	1-1
Section 2	Functional Descriptions -----	2-1
	Features -----	2-2
	Construction -----	2-2
Section 3	Installation -----	3-1
	Checking Instrument Components -----	3-1
	Installation Environment -----	3-1
	Location Conditions -----	3-2
	Checking Points -----	3-2
	Connecting to Main Power -----	3-2
	Instrument Plug-in -----	3-3
Section 4	Operation -----	4-1
	Setting Temperature -----	4-2
	Changing Temperature During Operation -----	4-3
	Check Elapsed Time During Operation -----	4-4
	Stopping Temperature Control Operation -----	4-4
	Setting shaker Speed -----	4-4
	Stopping Shaker Operation -----	4-5
	Timer Mode -----	4-5
	Setting T1 Timer -----	4-6
	Setting T2 Timer -----	4-7
	Checking Remaining Time During Timer Operation -----	4-8
	Stopping Timer During Operation -----	4-9
	Program Mode -----	4-9
	Starting a User Program -----	4-10
	Display During Program Operation -----	4-12
	Editing a User Program -----	4-13
	Viewing Program Setting -----	4-16
	Stopping Program -----	4-17
	Confirming Program End -----	4-17
	Resetting All User Programs -----	4-18

Table of Contents

Section 4	Reset Individual User Program -----	4-18
	Interval Mix Program -----	4-19
	How to Replace a Block -----	4-21
	Offset -----	4-22
Section 5	Safety Device -----	5-1
Section 6	Maintenance -----	6-1
	Cleaning Product -----	6-1
	Cleaning Accessories -----	6-1
	Relocation -----	6-2
	Keeping Product -----	6-2
Section 7	Troubleshooting -----	7-1
Section 8	Accessories -----	8-1
Section 9	Technical Specifications -----	9-1
	Disposing of the Product -----	9-2
Section 10	Warranty Information -----	10-1

Section 1 Warnings and Cautions

WARNING

Ignoring the following warnings could cause serious injuries or even fatal accidents.

Case of explosive and flammable chemicals, you must use with sufficient safety countermeasure.

In accordance with experiment, you should install safety devices and should follow suitable regulations in your laboratory.

Do not install the product in the place that the gas could leak out. Do not use in a place that has industrial oil smoke and metallic dust. It causes fire or electric shock.

Do not use the machine near places where explosion can occur due to organic evaporating gases.

Explosive materials: Acid, Esther, Nitro compound

Inflammable materials: salt peroxides, inorganic peroxide, salt acids.

Do not use the machine at places where moisture is high and flooding can be happened.

Check electrical requirements described in this operation manual or on the ID plate of this instrument before use.

Connect this instrument to a dedicated power outlet nearby.

Make sure to connect this instrument only to properly grounded power outlets to protect you and your instrument. Do not ground to gas pipes or water pipes.

Unplug when there is strange sound, smell and smoke from the product. Stop operating and request service.

Do not assemble, repair, modify on your own. The product may not work well and electric shock could change the efficiency of the product. Also this will void the warranty.

⚠ CAUTION

Indicates a hazardous situation which, if not avoided, may result in minor or moderate injury.

Do not touch block immediately, even power off. Because the block might be have Residual heat. It may be cause burns from high temperature of block, seemingly invisible.

Do not forget plugging off, after product main switch off. It is safety regulations for the next user.

Do not put heavy things on the power line. Do not put the machine on the line. It may take off the wire coating and cause electric shock or fire.

Do not touch it with wet hands and connect the main plug correctly. It may cause the electric shock or injuries.

Install power outlet near instrument for convenience.

Do not install the shaker near machinery generating high frequency noise. Avoid installing near high frequency- welding machine, sewing machine, and mass SCR controller.

Do not inject any liquid and inflammable things inside of product.

Do not pour water or put liquid on the top of the product when cleaning. Intercept the main power immediately and request the service when water may be in the product.

Do not let the product take any strong shock or vibration. It causes abnormal operation or trouble. It may deteriorate the ability of the product and not obtain correct results.

Do not install the instrument near strong electric field exposed environment.

Caution, the pace maker or magnetic recording instrument might be influenced by our instruments and magnetic stick.

Do not sprinkle insecticide or flammable spray on the product. Use smooth cloths. Cleaning with solvent can cause fire and deformity.

Power off while product cleaning. It may cause the electric shock or fire

Section 2 Functional Description

Digital Shaking Drybath is generally used in for mixing sample, homogenization process, separation of the DNA / Plasmid, gel elution, and DNA, RNA, Protein, Yeast denaturation. General application include lipid extractions, denaturation of DNA, RNA and proteins, DNA/plasmid isolation and yeast and bacteria cultivation.

Features Performance

- Precision accuracy is ensured (0.1°C) by its PID controller.
- Operation temperature range is Ambient +5 ~ 100°C.
- Provide stable shaking performance (rpm: min.150 ~ max.1500 depending on the attached accessories).
- Users can conveniently set timer operation (1min ~ 99hour 59min). Two kinds of timers are provided for proper uses. Also, the timer can be check remaining time or re-set. [Refer to Timer Modes section.]
- Provide program modes that users can schedule as their experiment protocols.
 - Up to 10 programs allowed for memory storage (include 3 standard interval mix programs - continuously switching between shaking and phasing)
 - Up to 10 steps allowed for each program.
- Use of BLDC motor provides low noise and strong durability.
- Noise and vibration is minimized by low-profile design.

Safety

- Polypropylene (PP) material block covers, decrease the chance of accidental injuries.
- Smooth starting function to protect the split out of sample.
- Designed by Water-proof structure that minimizes influx of reagents or solution.
- Designed by threefold safety system to cut off main power ; overheating protection for heater, overheating protection for circuit, and over-current protection circuit structure

Features(continued) Ease of Use

- Available to use 96-well, 0.5ml, 1.5ml/2.0ml, 15ml, Ø12, Ø13, 50ml tube block [Refer to Accessories section]
- Easy to check a set temperature value and operating conditions through VFD (Vacuum Fluorescent Display).
- Convenient to control the product by Touch Button and Dial Knob.
- The main body is made of polypropylene (PP). Polypropylene (PP) that is resistant to chemicals and is easy to clean.

Construction

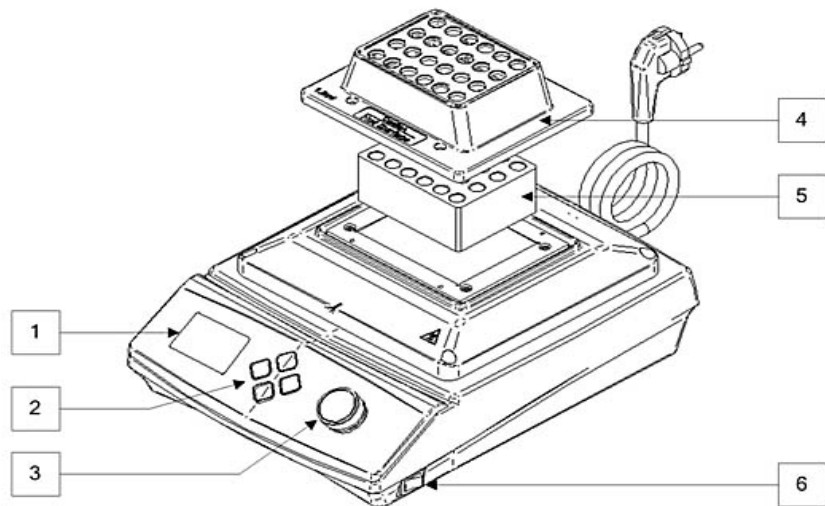

(1) VFD (Vacuum Fluorescent Display) : To display operating status.

(2) Touch Button : To choose temperature and time

(3) Dial Knob : To set a temperature value and time

(4) Block cover (Included in purchasing a block option)

(5) 1.5ml/2.0ml tube block (Optional): 96-well, 0.5ml, 15ml, Ø12, Ø13, 50ml tube blocks can be used. [Refer to Accessories section]

(6) Power Switch: Power ON/OFF

**Construction
(continued)**

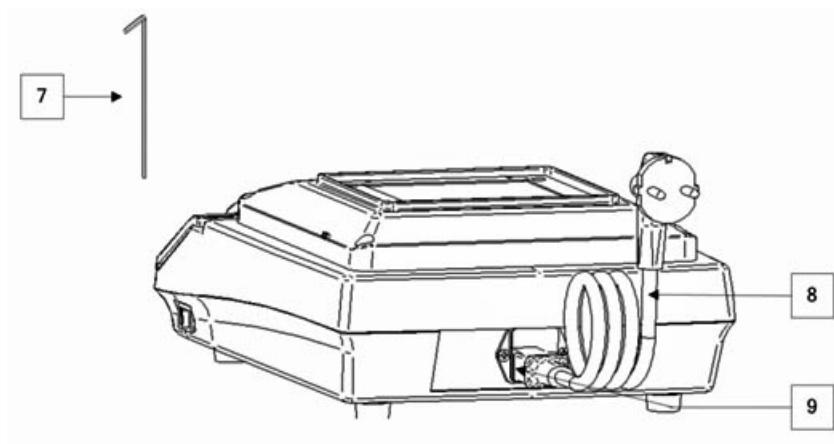

(7) Hexagon Wrench: To assemble block cover to the main body (included in purchasing a block option).



(8) Power Cord

(9) Socket: Connecting the power cable into the socket.

Section 3 Installation

Check to see if there is any damage in the instrument packaging before unpacking. Then unpack the instrument carefully. Inspect to see that the instrument was not damaged during transportation.

Checking Instrument Components Check the instrument components supplied in the package after unpacking. If a noticeable issue or an omission is found, immediately notify your local Thermo Scientific dealer's Service Department.

Item	Figure	Quantity	Description
Main body		1	--
Power cord		1	--
Operation Manual		1	--

Installation Environment The unit should be installed in a suitable environment as described below.



- Avoid direct sunlight



- Room temperature should be 5°C ~ 40°C



- Relative Humidity (RH%) should be less than 80%.



- Altitude should be less than 2,000m.

Location Conditions Place the instrument far from the other instruments and keep the proper distance (normally more than 30cm).

⚠ WARNING

- Place and install the instrument on a stable fireproof surface with non-slip and non-moisture and avoid direct sunlight & heat.

- Checking Points**
- Unit should be used on a flat working table with safety facility.
 - Unit should not be used where a combustible gas leak might occur.
 - Unit should not be used in high electric field environments.
 - Unit should not be used in dangerous places of electric leakage, water leakage, and submersion.
 - Unit should not be used where there are industrial harmful gases or metal dusts.

Connecting to Main Power Connect the electric power to the unit according to the following process.

STEP 1: Switch off the main switch before connecting AC power cable.

STEP 2: Connect the power cable to the socket of the main body and to the power supply.

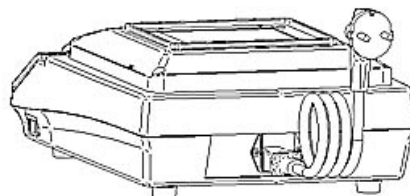

⚠ WARNING



Electrical Shock Hazard

- Ensure that the instrument is connected to an appropriate power supply in terms of voltage, phase and capacity.
- Use a grounded power source.
- Never use a forked socket, or a double-tapped socket.
- Failure to obey a safety warning will cause a drop in a line voltage, resulting in a loss of power and causing risk of fire by turning the cable.
- Do not handle or touch electric codes and devices with wet hands.
- Wrong power supply can cause serious damages to the instrument and body; even to death.

Instrument Plug-in When you switch on, the instrument displays as below.

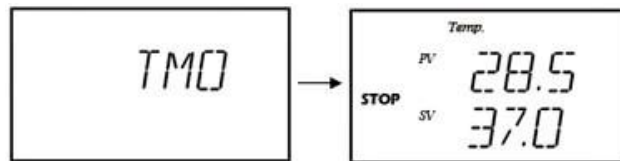

NOTICE

- Touch Buttons are displayed with green or red colored backlight. When a backlight color of a button is green, the button is valid so that it can sense user's touches to itself. When it is red, it cannot sense the touches.
- Before displaying the temperature, the instrument needs start-up latency time shortly.



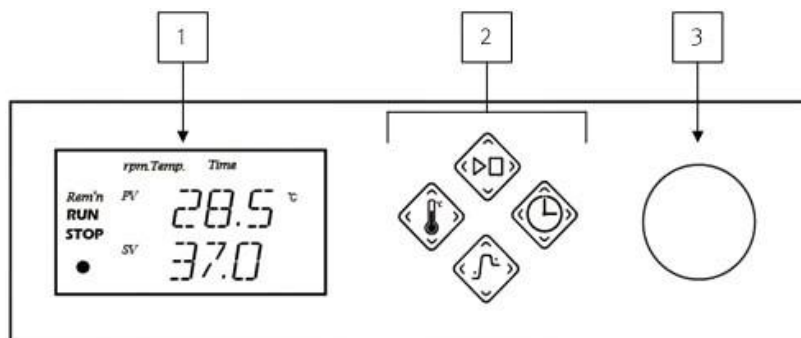

Section 4 Operation



(1) VFD (Vacuum Fluorescent Display): Set value of temperature and shaking speed (RPM) and current state of operation can be checked.

A	<i>Rem'n</i>	Remaining time during operation
B	RUN	Indicate heating control ON.
C	STOP	Indicate heating control OFF.
D	●	Indicate Heater is working.
E	PV	Process Value (Current value)
F	SV	Set Value (Target value)
G	rpm	Indicate shaking speed is now displayed.
H	Temp	Indicate temperature is now displayed.
I	Time	Indicate time (elapsed time or remaining time) is now displayed or timer is operating.

(2) Touch buttons:

A		START/STOP	Start and stop the instrument. Go back one step when setting parameters for operation.
B		TEMP	Set temperature. Step into Offset setting.
C		PROGRAM	Step into the program mode.
D		TIMER	Set timer function. Check remaining time or elapsed time.

(3) Dial knob: It can be used when setting temperature, shaking speed, timer and program parameters.

Setting Temperature (1) Press TEMP when the temperature control stops.

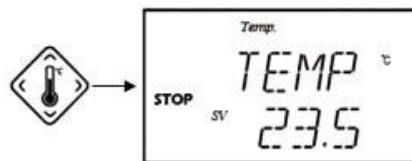

(2) You can set temperature by adjusting Dial Knob with 0.1°C resolution (e.g., change the SV from 23.5°C to 60.0°C)

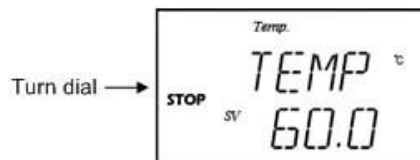

At any time, you can be out of temperature set mode by pressing START/STOP.

(3) Pushing Dial Knob, you can save the target temperature as a temperature SV (Set Value).



Setting Temperature (continued) (4) Then you can operate it by pressing START/STOP.

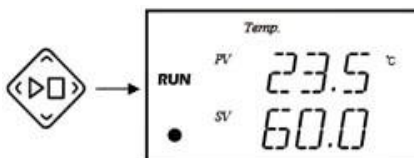

NOTICE

- To step back from temperature setting, press START/STOP. The instrument returns to standby.
- You can also change the temperature SV when the instrument is in operation.[Refer to 4-3 Changing Temperature During Operation]
- The instrument keeps the temperature after the temperature PV(Process Value) reaches to its SV by repeating Heater on and off.
- SV of temperature is updated to the last set value. This will not be initialized even after Power Switch off and on.
- You can check elapsed time by pressing TIMER (press one time) during operation.
- You can set Offset by pressing TEMP during operation.

CAUTION

- The instrument and its accessories can be hot even though the Power Switch is off.

Changing Temperature During Operation It is possible to change a target temperature by pressing TEMP during operation. Change the temperature SV by adjusting Dial Knob and you can start it by pushing Dial Knob.

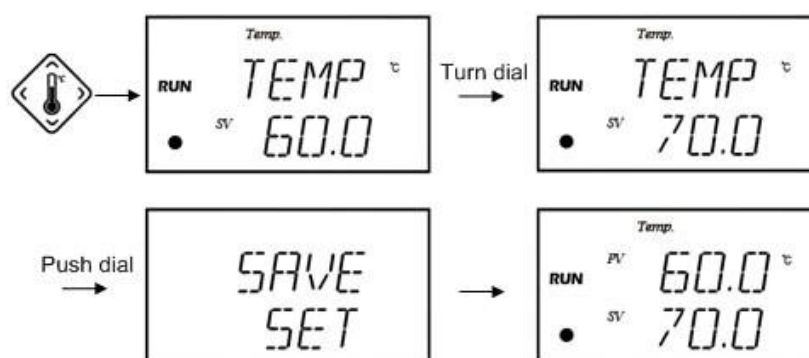

NOTICE

- You can escape from the temperature changing process by pressing START/STOP or leaving it without additional input for 10 seconds.

Check Elapsed Time During Operation Elapsed time for operation can be checked by pressing TIMER once when the instrument is in operation.

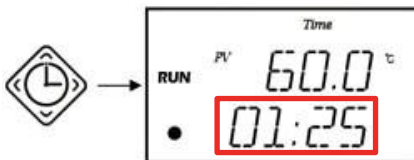

[Elapsed time]

To step back from the elapsed time check, press START/STOP or leave the instrument for 10 seconds.

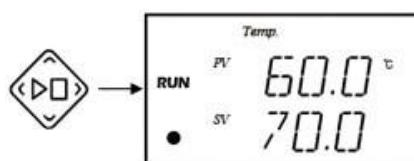

Stopping Temperature Control Operation Press START/STOP during General Mode operation. The instrument will stop operation.

⚠ CAUTION

- Instrument and its accessories can be hot even though power switch is off.

Setting Shaker Speed In General Mode, shaking speed in RPM can be set by using Dial Knob.

(1) Push Dial Knob to set RPM value for shaking function of the instrument.

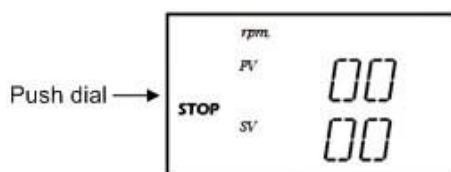

(2) Turn Dial Knob to set a target RPM as a RPM SV(Set Value). Shaking part of the instrument starts operating immediately after turning Dial Knob. After setting the shaking RPM, push Dial Knob to be out of the RPM setting.

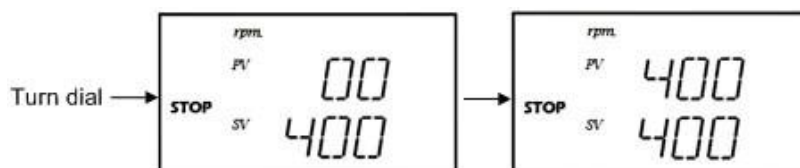

Stopping Shaker Operation You can stop the shaking operation by turning Dial Knob left side to make RPM SV 00. The instrument stops shortly after setting SV to 00.

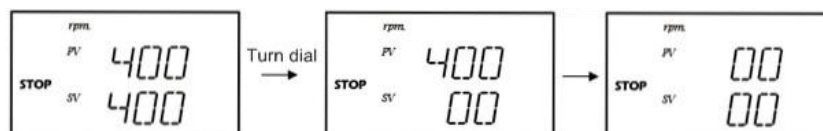

Timer Modes This instrument provides two types of timers (T1 and T2 timer). The timers are different in a operating condition and point of time countdown.

T1 timer	T2 timer
Set when heating control is operating.	Set when heating control is not operating.
Start counting down the timer immediately.	Start counting down the timer just after it reaches temperature SV.

NOTICE

- You can escape from the temperature changing process by pressing START/STOP or leaving it without additional input for 10 seconds. Timer can be set from 1min~99h 59min.
- Exit the timer setting in Timer mode by pressing START/STOP repeatedly.
- T1 timer starts counting down when set the timer, immediately and “Time” in VFD blinks.
- T2 timer starts counting down when temperature reaches to SV and “Time” in VFD blinks.
- Elapsed time can be checked by pressing TIMER once and get into T1 timer setting by pressing TIMER twice during temperature control operation.

Setting T1 Timer T1 timer is for setting a timer during temperature control operation. It also requires SVs for temperature and time.

In T1 timer mode, regardless of reaching the temperature SV, the timer starts to count down just after the timer setting.

(1) Press TIMER twice during temperature control operation.

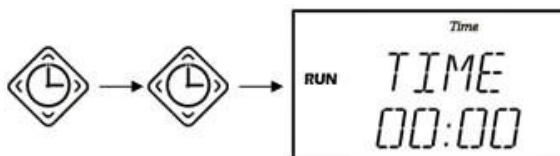

(2) Select a desired time by using Dial Knob in the order of hour, minute. You can set the timer from 1min to 99hour 59min.

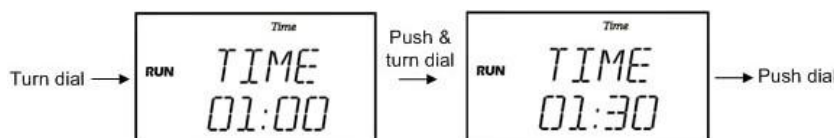

(3) Input a target temperature by using Dial Knob and save it by pushing Dial Knob.

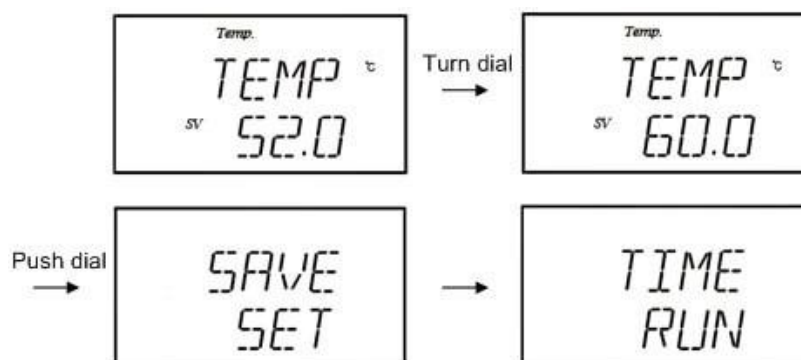

(4) When the timer operation ends, the instrument generates a sound alarm with a display as follows. Confirm the end of the timer operation by using Touch Buttons or Dial Knob

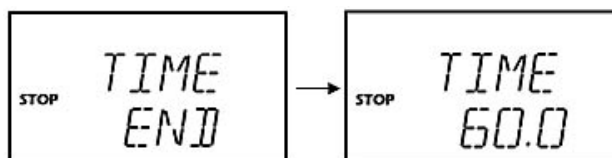

[Current temperature]

Setting T1 Timer (continued)

NOTICE

- Every set target time(time SV) is memorized as an initial value of timer. You can see the last set time SV when setting a new time SV, as an initial value.
- During the timer operation, you can stop the instrument by pressing START/STOP. [Refer to Stopping Timer during Operation in this section.]
- During timer setting, the instrument returns to standby if you leave it for about 10 seconds without saving the time value.

Setting T2 Timer

T2 timer can be set only when the instrument stops temperature control. After setting T2 timer, the temperature control starts operating to make the temperature PV the same to the temperature SV. When its temperature reaches to the temperature SV, the timer starts to count down.

(1) Press TIMER when the temperature control is not operating.

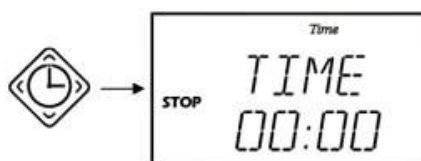

(2) Input Hour, Minutes by using Dial Knob.

(Timer range: 1min ~ 99hour 59min)

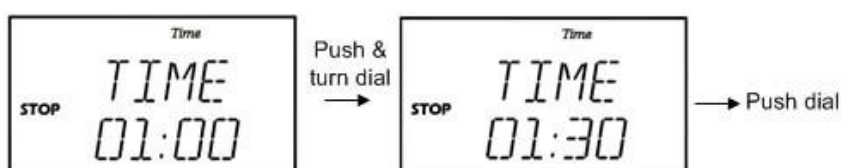

(3) Input a target temperature by using Dial Knob and save it by pushing Dial Knob. In case of that you do not change the temperature SV, just push Dial Knob.

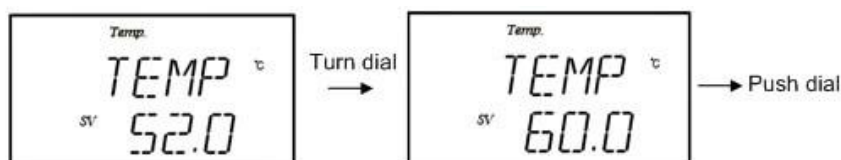

**Setting T2 Timer
(continued)**

(4) Select whether start operating the instrument or not by using Dial Knob.

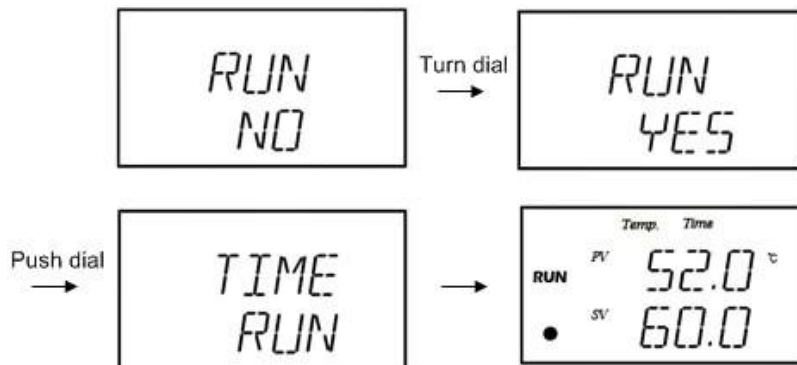

When it reaches to the set temperature, the timer starts with a sound alarm.

(5) When the timer operation ends, the instrument generates a sound alarm with a display as follows. Confirm the end of the timer operation by using Touch Buttons or Dial Knob.

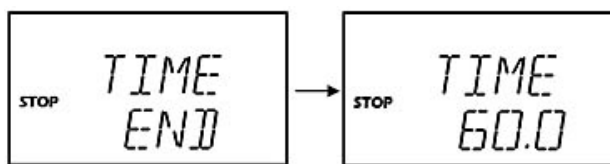

[Current temperature]

NOTICE

- If you press Dial Knob in "RUN NO", all inputs for T2 timer are canceled and the instrument returns to the standby.

Checking Remaining Time During Timer Operation

Remaining time for timer operation can be checked by pressing TIMER once when the instrument is in operation.

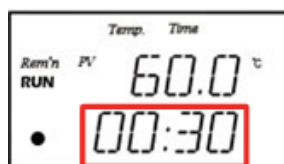

[Remaining time]

During the checking process, you can escape from the process if you press START/STOP or leave the instrument without additional input for 10 seconds.

Stopping Timer During Operation

You can stop the operation by pressing START/STOP.

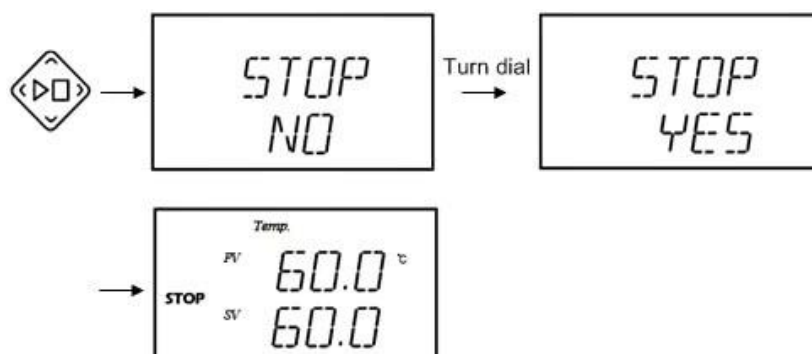

Confirm the end of the timer operation by using Touch Buttons or Dial Knob.

⚠ CAUTION

- The instrument and its accessories can be hot even though the Power Switch is off.

Program Mode

This instrument provides 10 programs. 3 programs are standard interval mixes and the other 7 programs are user editable programs. Each program consists of steps (max.10 steps) that have parameters including SVs for temperature, time, and shaking RPM. It also provides a looping function that repeats a program as many times as user selected (range: 1~99, infinity).

[Diagram of Program Mode]

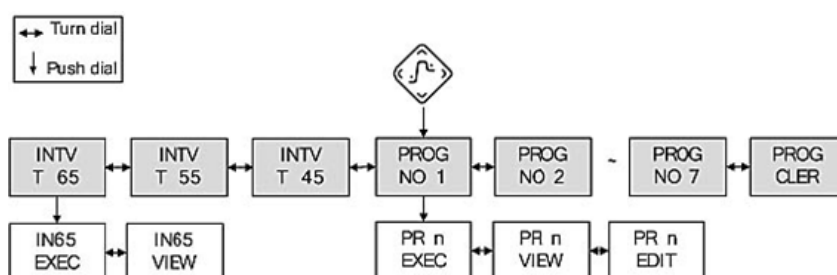

ABBREVIATIONS	Descriptions
PROG (PR)	User program
INTV T (IN)	Interval mix program
EXEC	Run a program
VIEW	View configurations of a program
EDIT	Edit configurations of a program
CLER	Clear all programs or a program

Program Mode [Temperature and shaking speed control in Program Mode] (continued)

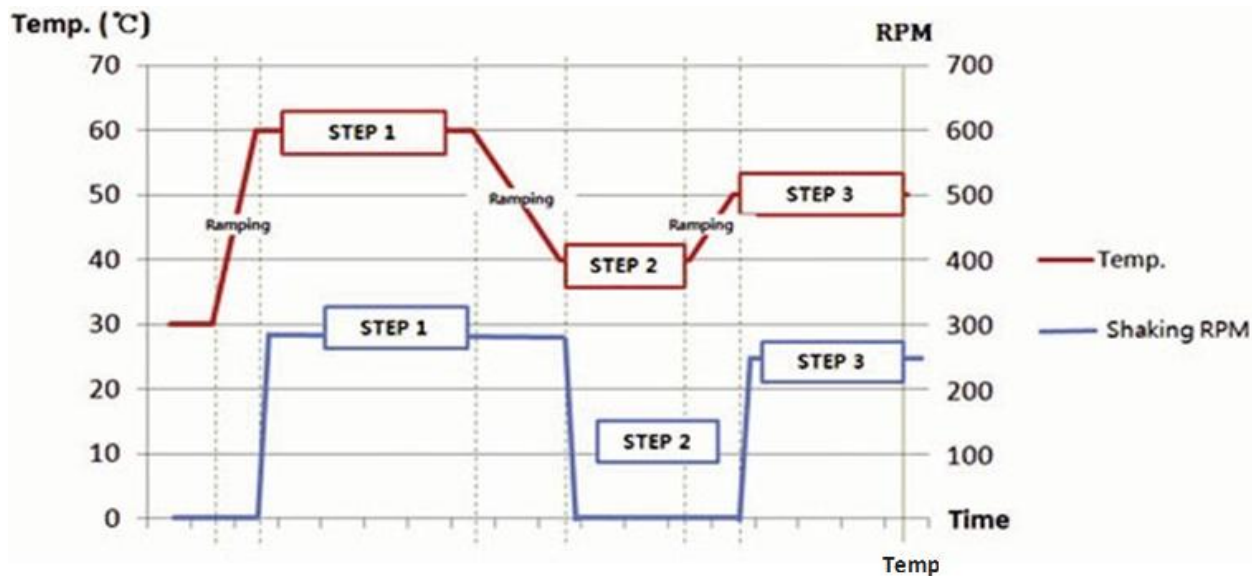

NOTICE

- A time SV for a step starts to be counted just after the instrument temperature reaches to the temperature SV of the step.
- If the time SV for a step is set as "00:00", then the step will be skipped and the next step will proceed.
- It is possible to repeat a program from 1 to 99 times or infinitely. It depends on the user's choice.
- In program mode operation, after finishing a step, the instrument go through ramping process until it reaches the target temperature of the next step stably. Until starting the step, the shaking RPM of the previous step is maintained.
- The saving program can be saved from 1 to 99 times or infinitely.
- The operation of a program mode can be stopped by pressing START/STOP. [Refer to Stopping Program in this section.]

Starting a User Program (1) Press the PROGRAM when the instrument is on standby



Starting a User Program (continued) (2) Select one of user programs by turning Dial Knob to the right side.

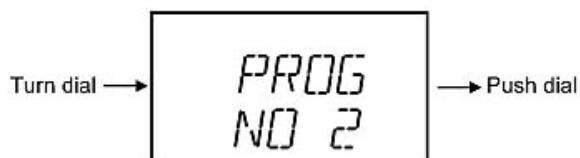

(3) Select a program execution "PR n EXEC" by pushing Dial Knob (n : program number).

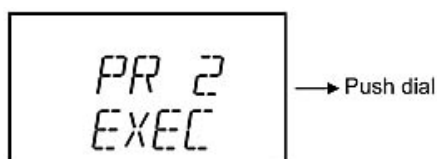

(4) Select the number of loops for program repeats by turning Dial Knob and operate it by pushing Dial Knob.

- Turn Dial Knob to the right : You can select the number of repeats from 1 to 99.
- Turn Dial Knob to the left : Repeat the program infinitely.



[In case of repeating 5 times]



[In case of repeating infinitely]

Display During Program Operation

During program mode operation, the instrument displays its operating status, “program number and current step” → “remaining time of current step” → “the current number of repeats in infinite loop” or “the current of iterations and total number of iterations” → “process value and set value for RPM” → “process value and set value for temperature”.

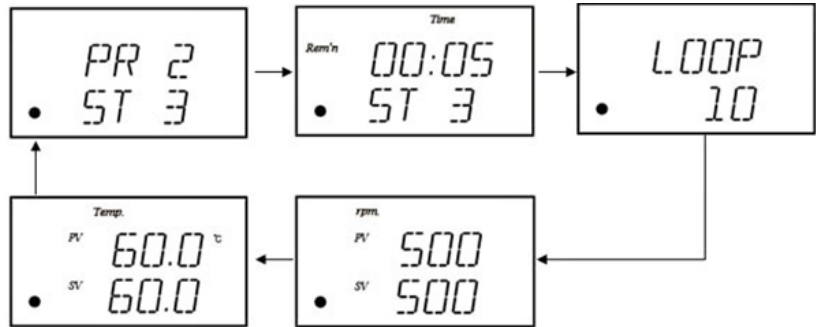

[Program 2 and step 3] → [remaining time : 5min and step 3] → [10th iteration of infinite loop] → [RPM – PV: 500, SV: 500] → [temperature – PV : 60°C, SV : 60°C,]

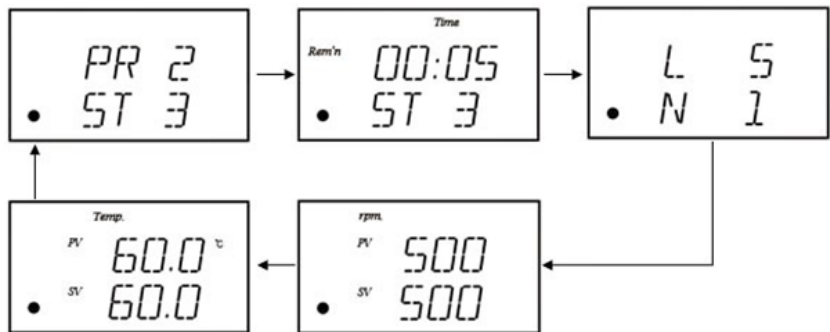

[Program 2 and step 3] → [remaining time: 5min and step 3] → [1st iteration of 5 total repeats] → [RPM – PV: 500, SV: 500] → [temperature – PV: 60°C, SV: 60°C,]

Display During Program Operation (continued) In case of ramping periods between two different steps, the display for remaining time is replaced to alternative displays indicating that the instrument is on temperature ramping.

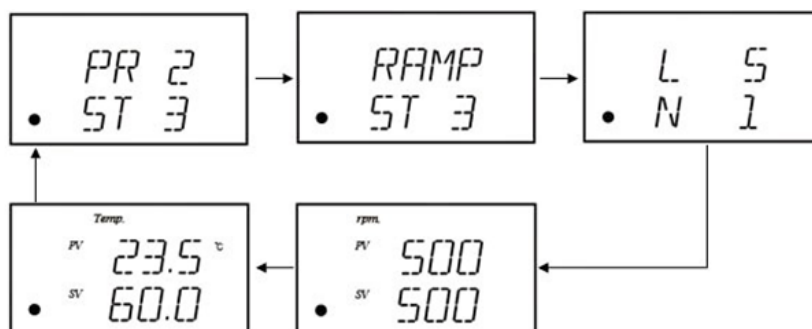

[Program 2 and step 3] → [ramping to step 3 temperature] → [1st iteration of 5 total repeats] → [RPM - PV: 500, SV: 500] → [temperature - PV: 23.5°C, SV: 60°C,]

Editing Program (1) Press PROGRAM when the instrument is on standby.

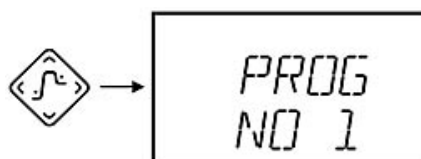

(2) Select a program you want to edit by turning and pushing Dial Knob.

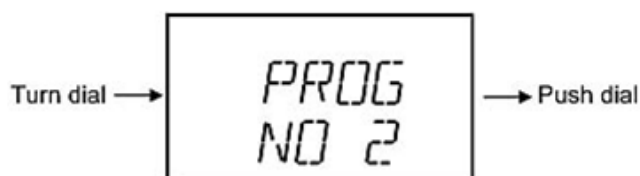

[In case of editing program no.2]

(3) Select a program execution "PR n EDIT" by turning and pushing Dial Knob as below (n : program number).



- Editing Program (continued)** (4) Enter the number of steps for the program. You can set up 10 steps for a program.

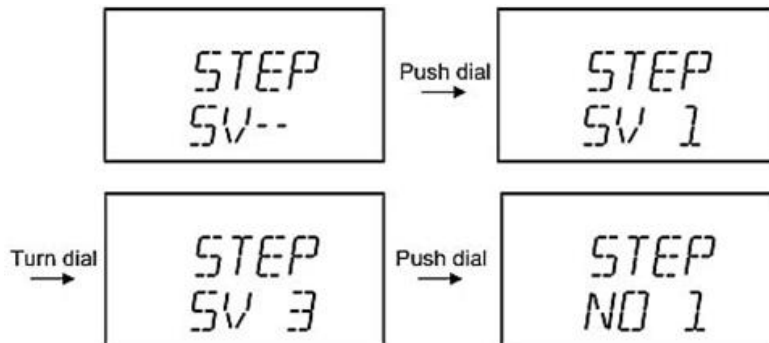

[In case of setting 3 steps for program 2]

- (5) The program is reset and generates new steps as many as step SV. Then you can set SVs for temperature, time and shaking RPM for each step by using Dial Knob.



- (6) Enter the target temperature and time for the step, and then save the entered value (SVs) as below.

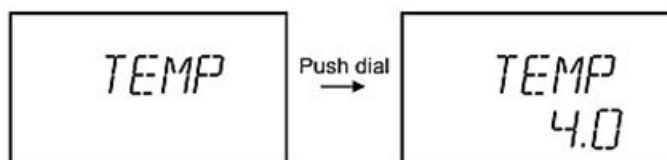

[Enter temperature for the step]

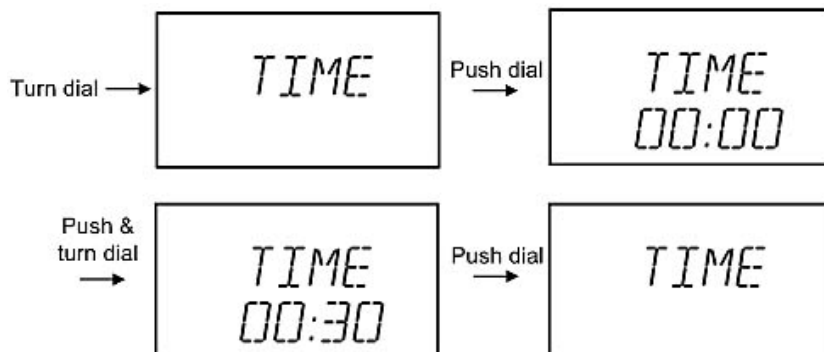

[Enter time for the step]

Editing Program (continued)

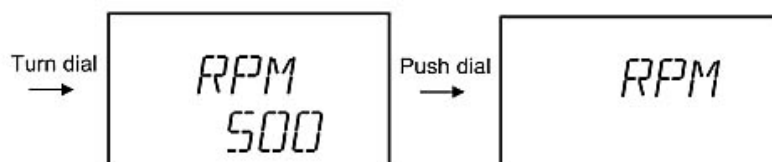
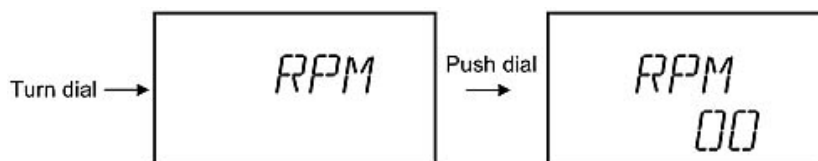

[Enter shaking RPM for the step]

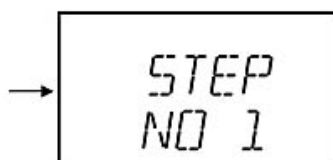

[Save the entered value]

If you skip the saving process, all entered inputs are not saved.

By applying (5) and (6) for every step, you can complete program editing

(7) After saving all generated steps, push START/STOP to escape program editing.

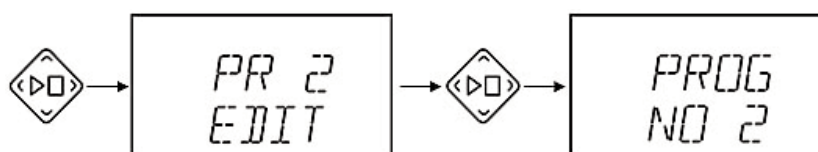

NOTICE

- If you want to write a new program on a program slot, set step size of the program slot. The step size setting includes clearing existing program and initializes a new program. [Refer to 4-18 Reset Individual User Program]
- Just after you set the step size for a program, every step generated is initialized (0° for temperature and 00:00 for time.) This instrument is supposed to skip steps that have 00:00 for time. So, non-edited steps will be skipped in program execution.

Viewing Program Setting

(1) Press PROGRAM when the instrument is on standby.



(2) Select a program you want to view by turning and pushing Dial Knob.



[In case of viewing program No.2]

(3) Select a program execution "PR n View" by turning and pushing Dial Knob as below (n : program number).

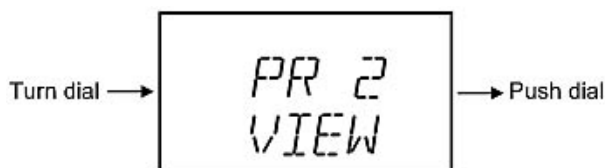

(4) Turn Dial Knob to find a specific step you want to view. Push Dial Knob to get into the step.



[In case of viewing step No.3]

And then you can view the SVs of temperature, time and RPM for the step.

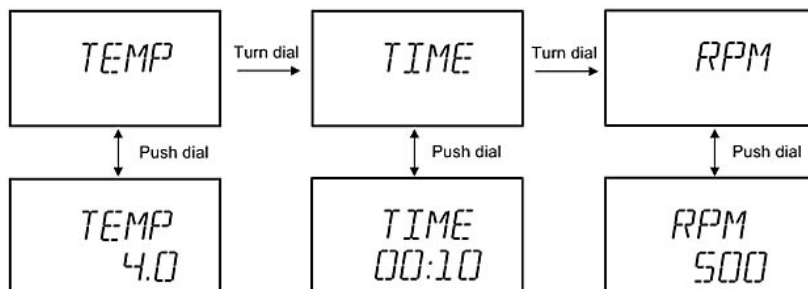

Viewing Program Setting (continued) (5) After viewing the program setting, move out by using START/STOP.

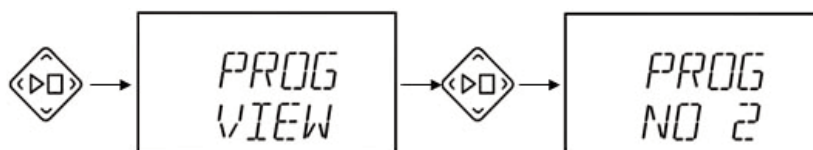

Stopping Program By pressing START/STOP, you can stop program operation.

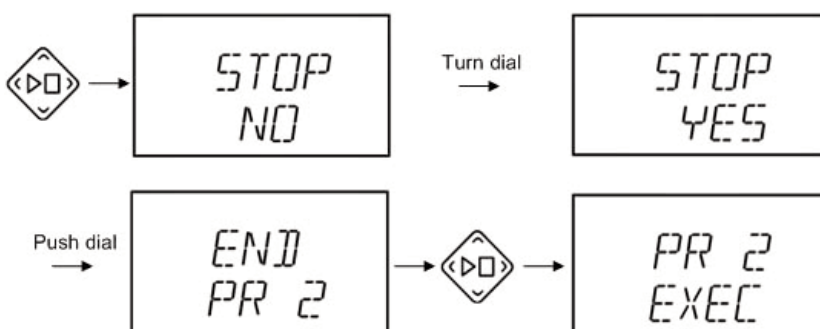

Confirming Program End "END PR n" is displayed with sound alarm at the end of a program (n:program number). Check the program end by pressing START/STOP.

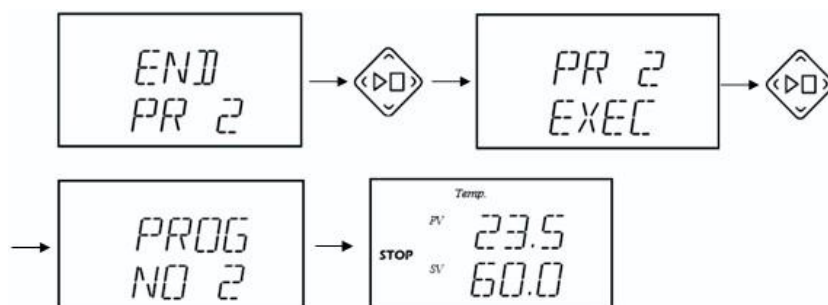

Resetting All User Programs

(1) Press PROGRAM at standby.



(2) Turn Dial Knob to the right end and select "PROG CLER".

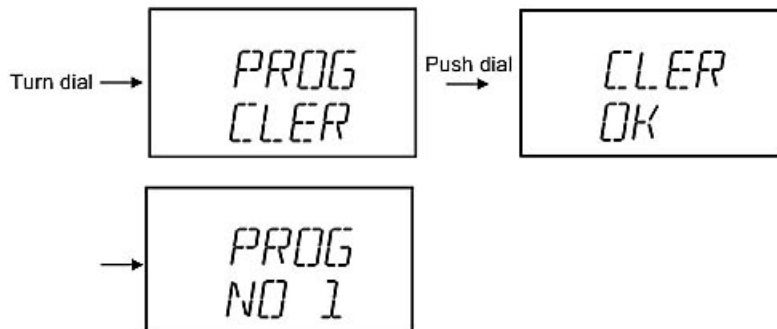

All User Programs are initialized. It takes some time for resetting all. Note that Interval Mix is not affected by the reset. All parameters except the number of repeats for Interval Mix is fixed.

Reset Individual User Program

(1) Press PROGRAM at standby.



(2) Select a target program that needs to be deleted.

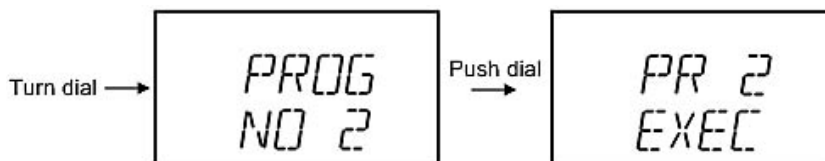

[In case of resetting program 2]

(3) Turn Dial Knob to the right and push "PR n EDIT" (n : program number).



Reset Individual User Program (continued) (4) Turn Dial Knob to the right end and press Dial Knob at “STEP CLER”.

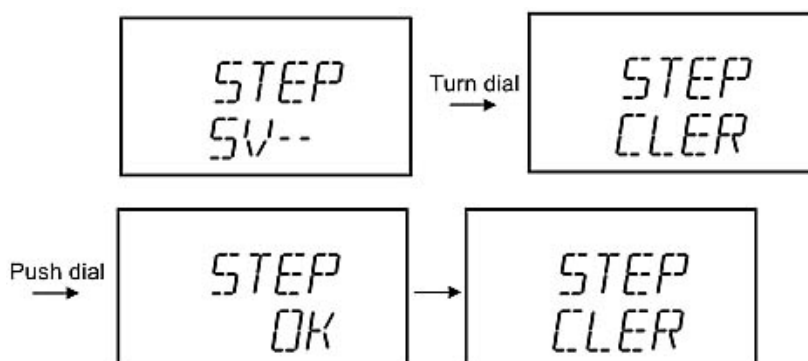

All previous steps of the program are deleted.

NOTICE

- Setting a step size (“STEP SV”) for a program includes resetting the previous program and generating new steps as many as the set step size.

Interval Mix Program The Digital Shaking Drybath provides 3 standard Interval Mixes that help enzyme reaction be more efficient. Interval Mixes are programmed in advance as follows.

Interval mix program			
SV (Set Value)	INTV T 45	INTV T 55	INTV T 65
Temperature (°Cm)	45	55	65
Shaking speed (rpm)	1000	1000	1000
Time pattern	1min operation, 1min pause	1min operation, 1min pause	1min operation, 1min pause

(1) Press PROGRAM at standby.

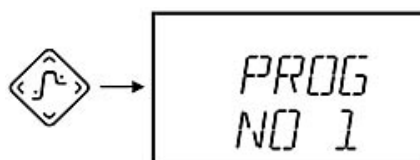

- Interval Mix Program (continued)** (2) Turn Dial Knob to the left and select a Interval Mix Program proper to your protocol.



- (3) Select "INTV EXEC" using Dial Knob.



- (4) Select the number of repeats by turning Dial Knob and operate the program by pushing Dial Knob.

- Turn Dial Knob to the number of repeats from 1~99.
- Turn Dial Knob to the left.
- you can select the number of repeats to infinity.

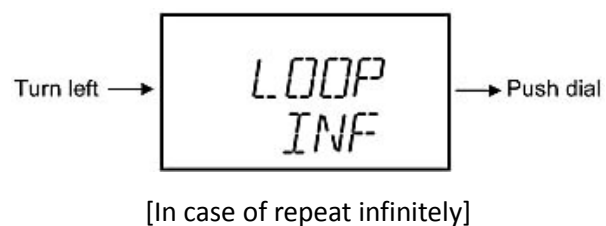
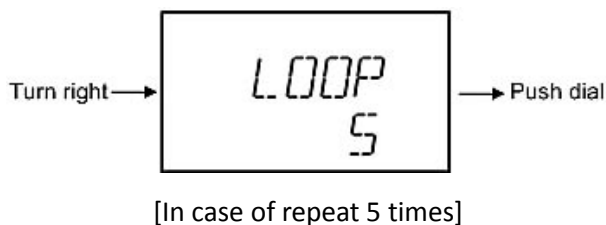

NOTICE

- Operating Interval Mix Program is almost the same to operating User Program.

How to Replace a Block

- (1) Take out the plug.
- (2) Remove a PEEK bolt by turning hexagon wrench counterclockwise.

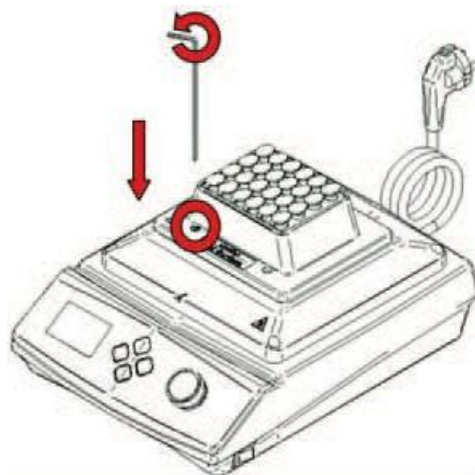

- (3) Take the cover and block out from the main body in order.

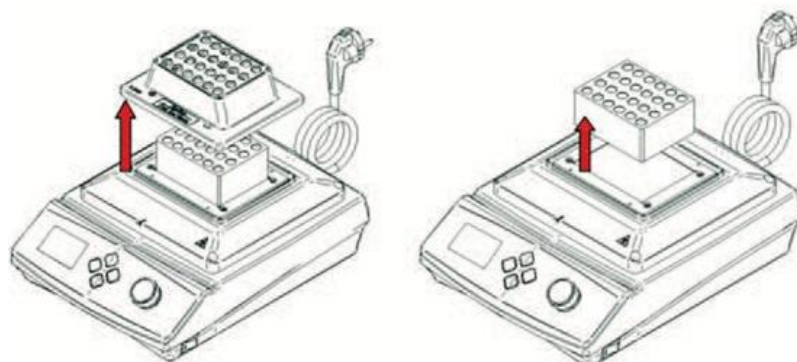

[Cover Separation]

[Block Separation]

- (4) Place another block and cover in order. Fix PEEK bolt to the cover by turning hexagon wrench clockwise.

⚠ CAUTION

- Before replacing a block, detach tubes, vials, microplate etc. from the block.
- You should be careful in handling the instrument. The instrument and its accessories can be hot even though the Power Switch is off.
- Make sure that the block and PEEK bolt are inserted correctly.

Offset The temperature shown on the VFD is measured by a temperature sensor inside the instrument. However, this temperature can be different from the temperature of your own thermometer which you may use as a standard for your specific applications. If needed, you can offset such temperature differences within the range of $\pm 50^{\circ}\text{C}$ at 0.1°C interval.

The temperature offset setting procedures are as follows:

- (1) Turn the power on.

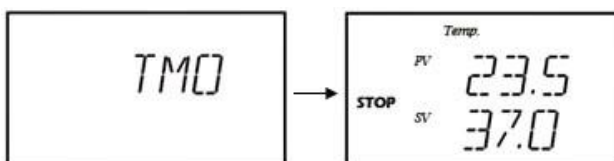

- (2) Press TEMP until the following temperature offsetting screen appears with audible alarm.

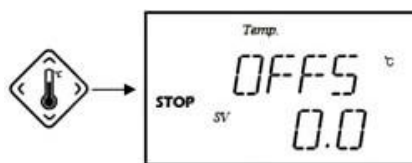

- (3) Select the offset value by turning the Dial Knob appropriately and, when selected, save it by pushing Dial Knob. When properly saved, the save confirmation screen will appear as shown below.

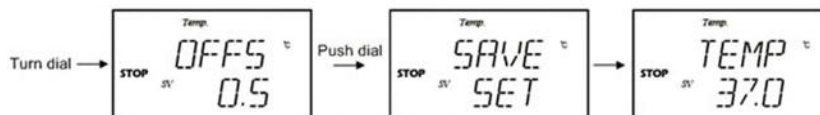

[Offset value selection 0.5°C ,]

- (4) After confirm saving offset, setting a SV temperature is automatically displayed as below. Finally, it returns to standby state with PV that offset is applied to and the changed SV.

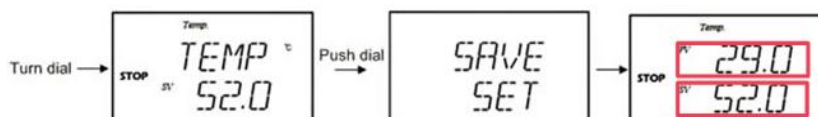

[Save setting temperature 52.0°C ,]

Offset (continued) If you press START/STOP or leave the instrument for about 15 seconds in this step, then it returns to standby and you can see that PV is affected by the offset.

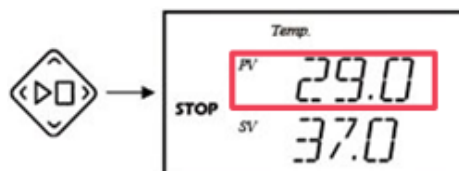

NOTICE

- You can except the offset by pressing the START/STOP during offset input.
- During operation, you can set offset by pressing TEMP.

Section 5 Safety Device

(1) The overheat protection device for Block.

The power of this instrument automatically cuts off when the block's temperature overheats more than 115°C, to protect the instrument.

(2) The circuit protection device.

The power automatically switches off when the circuit's temperature overheats in a certain degree which will activate this device to protect the circuit inside of the instrument.

(3) The overcurrent protection device.

The power automatically switches off when the current flows more than the given current value which will activate this device to protect the instrument.

(4) Overheating / undercooling protection system

In case that the sensed temperature is over 140°C and it maintains for 15 seconds, Err2 (Error 2) is displayed on the screen with a beep and temperature control stops.

In case that the sensed temperature is less than -5 °C and it maintains for 15 seconds, Err3 (Error 3) is displayed on the screen with a beep and temperature control stops.

NOTICE

- The instrument should be used after fully cooling it down when the instrument is switched off by these kinds of the protection devices.

Section 6 Maintenance

Classifications	Checking Time Period	
	Daily	Weekly
Power cord		
The conditions of connection for power supply and an adaptor.	•	
The presence of power supply and an adaptor contact wetting, and cable peeling off, and out of contact.	•	
Product surface cleaning		•
Block cleaning	•	
Controller function checking	•	
Check accessory attachments to the instrument are tight	•	

Cleaning Product Remove a contaminant by cleaning the instrument frequently with a soft cloth before and after using, otherwise it cannot be readily wiped out for a long time. Keep the unit clean always, without any contaminants.

CAUTION

- Do not put under the water.
- Do not damage inside of accessories and system. Use caution.
- Do not touch product with a high concentration of nitric acid, sulfuric acid, sodium hydroxide, acetone, benzene, phenol, toluene, chloroform, cresol, acetic acid series, and chlorine series corrosive solvent.
- Separate power cord from body, if not in use.
- Do not use chlorine bleach, ammonia-based cleaners, abrasives, ammonia, or metal scouring pads when cleaning.

Cleaning Accessories Remove a contaminant by cleaning the instrument frequently with a soft cloth before and after using, otherwise it cannot be readily wiped out for a long time. Keep the instrument clean always, without any contaminant.

- Relocation** (1) Disconnect the power cord from the power outlet.
(2) Pack the instrument and its accessories into the original packaging or any other suitable container before moving.

⚠ CAUTION

- Pay attention to avoid mechanical shock or vibration while moving instrument. Damages caused by mechanical shock or vibration may result in injury or fire.







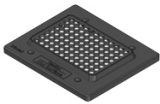

- Keeping Product** (1) Unplug the instrument from the main power.
(2) Clean the instrument with a soft cloth neatly.
(3) Store in a dry place after packing.

Section 7 Troubleshooting

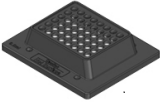

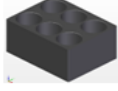
Electrical Trouble	Causes	Solution
The unit does not turn on	Incorrect electric power	Compare power source and voltage on the ID plate and make sure they are the same. ID plate is found on the back of unit.
	Power failure or circuit breaker shuts down	Find out the causes of power failure and recovery.
	Main plug not seated properly.	Check the electrical cord connection at the unit to ensure it is fully seated.
	Check the electrical cord connection at the unit to ensure it is fully seated.	If the socket / plug / main power line are cut, request service.
	PCB has damaged by reagent	Request service.
Room circuit breaker trips often when the unit is turned on or running	Too many plugs connect at the same time	<ol style="list-style-type: none"> 1. Check the circuit breaker size along with the voltage and current supplied to it. 2. Check that several similar units are inserted together, if so, you should not use overly.
	Product inner circuit problem	Request service.
No VFD	Power failure	Find out the causes of power failure and recovery.
	Main plug not seated properly.	Check the electrical cord connection at the instrument to ensure it is fully seated.
Button doesn't operate well	Power failure	Find out the causes of power failure and recovery.
	Button switch has damage	Request service.

Troubles During Operation	Causes	Action
Block is not heating up.	START/STOP is not pressed.	Press START/STOP on the control panel.
	Set temperature is lower than present temperature.	Check set temperature and adjust it properly.
	Heater failure	Request service.
	Circuit protection device cut off the power.	Take off the cord for cooling down the instrument and re-operate it.
	Product internal circuit problem	Request service.
Error 2 or Error 3 is displayed	<ol style="list-style-type: none"> 1. Temperature sensor problem 2. Board problem 	<ol style="list-style-type: none"> 1. Turn the power off and on after certain period of time 2. Request service
The Dial knob isn't operation correctly.	Dial knob or circuit problem	<ol style="list-style-type: none"> 1. Pull out the knob from the instrument and replace it again. 2. Request service.
Error message on the display	Product internal circuit problem	Request service.
The VFD lamp is not operating.	Product internal circuit problem	Request service.
Vibration is detected during acceleration, deceleration, and constant velocity.	Unit is out of balance.	Fix the unit on flat ground.
RPM is not operating well.	<ol style="list-style-type: none"> 1. Too heavy load of samples 2. Rubber band inside of the body is broken down. 	<ol style="list-style-type: none"> 1. Remove some samples. 2. Request service.

Section 8 Accessories

Designation			Order No.	Block dimension (W x D x H, mm)	Description
Block 96 well	Block		88880125	111 x 76.5 x 15	0.2ml x 96 holes
	Block cover				
Block 0.5 well	Block		88880126	98 x 76.5 x 30	0.5ml x 48 holes
	Block cover				
Block 1.5 ml / 2.0ml	Block		88880127	98 x 76.5 x 41	1.5ml / 2.0ml x 24 holes
	Block cover				
Block 50 ml	Block		88880128	98 x 76.5 x 51	50ml x 6 holes
	Block cover				
Block 15 ml	Block		88880151	98 x 76.5 x 51	15ml x 15 holes
	Block cover				

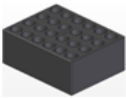
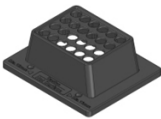
Section 8
Accessories

Designation			Order No.	Block dimension (W x D x H, mm)	Description
Block 12mm diameter	Block		88880152	98 x 76.5 x 51	12mm x 24 holes
	Block cover				
Block 13mm diameter	Block		88880153	98 x 76.5 x 51	13mm x 24 holes
	Block cover				

Section 9 Technical Specifications

Heating Shaker		Digital Shaking Drybath	
Temp	Control range (°C/°F)	Ambient + 5 to 100 / 41 to 212	
	Display	up to 100°C, 0.1°C resolution	
	Uniformity(±°C/°F)	0.5 / 0.9 at 80°C	
	Stability(±°C/°F)	0.15 / 0.27 at 80°C	
	Heater output, max. (W)	360	
	Control	PID feedback, 10 Memories, 10 steps/memory, Interval mix	
	Heating rate (°C/ min)	Approximately 5.0	
	Function	Offset	
Shaking	Speed range (guarantee)	96-well tube block	150 ~ 1500
		0.5ml tube block	150 ~ 1000
		1.5ml/2.0ml tube block	150 ~ 1000
		15ml tube block	150 ~ 900
		Ø12 tube block	150 ~ 850
		Ø13 tube block	150 ~ 850
		50ml tube block	150 ~ 800
	Speed display resolution (rpm)	0 ~ 1500	
	Orbital diameter (mm/Inch)	2 / 0.08	
	Motor type	BLDC	
Timer		1min to 99 hr 59 min	
Safety Device		Over temperature protection, Over current detection	
Control Panel		VFD (Vacuum Fluorescent Display), 4 Touch keys, Dial knob	
Material	External	PP, PC, Powder coated steel	
	Block	Black anodized Aluminum	
Electrical requirements (120V/60Hz, A)		3.4	
Electrical requirements (230V/50/60Hz, A)		1.7	
Exchangeable blocks		96-well, 0.5ml, 1.5ml/2.0ml, 15ml, Ø12, Ø13, 50ml tube block	
Overall dimension [W x D x H, (mm/inch)]		249x325x120/9.8x12.8x4.7	
Net weight (kg/lbs)		8.3 / 18.3	

Disposing of the Product



Before disposing of the shaker or any of its components:

1. The instrument should be cleaned and decontaminated to protect workers servicing the instrument, the environment or the public purchasing surplus instrument because the shaker can potentially be contaminated with biological material, chemicals or radioisotopes. Check with your institution or laboratory for individual policies and procedures for disposal of laboratory instrument.
2. Please contact your local governing body for regulations regarding disposal of electrical, electronic, metal (brass, aluminum, steel and stainless steel), refrigeration and rubber components. Thermo Scientific recommends the user find a local scavenger or laboratory instrument recycler to properly dispose of the instrument and its components.

THERMO FISHER SCIENTIFIC STANDARD PRODUCT WARRANTY

The Warranty Period starts two weeks from the date your equipment is shipped from our facility. This allows for shipping time so the warranty will go into effect at approximately the same time your equipment is delivered. The warranty protection extends to any subsequent owner during the first year warranty period.

During the first two (2) years, component parts proven to be non-conforming in materials or workmanship will be repaired or replaced at Thermo's expense, labor included. Installation and calibration are not covered by this warranty agreement. The Technical Services Department must be contacted for warranty determination and direction prior to performance of any repairs. Expendable items, glass, filters and gaskets are excluded from this warranty.

Replacement or repair of components parts or equipment under this warranty shall not extend the warranty to either the equipment or to the component part beyond the original warranty period. The Technical Services Department must give prior approval for return of any components or equipment. At Thermo's option, all non-conforming parts must be returned to Thermo Fisher Scientific postage paid and replacement parts are shipped FOB destination.

THIS WARRANTY IS EXCLUSIVE AND IN LIEU OF ALL OTHER WARRANTIES, WHETHER WRITTEN, ORAL OR IMPLIED. NO WARRANTIES OF MERCHANTABILITY OR FITNESS FOR A PARTICULAR PURPOSE SHALL APPLY. Thermo shall not be liable for any indirect or consequential damages including, without limitation, damages relating to lost profits or loss of products.

Your local Thermo Sales Office is ready to help with comprehensive site preparation information before your equipment arrives. Printed instruction manuals carefully detail equipment installation, operation and preventive maintenance.

If equipment service is required, please call your Technical Services Department at 1-800-438-4851 (USA and Canada) or 1-740-373-4763. We're ready to answer your questions on equipment warranty, operation, maintenance, service and special application. Outside the USA, contact your local distributor for warranty information.

Rev. 0 9/13



For the name of the authorized Thermo Scientific product dealer nearest you or any additional information, contact us:

North America: USA/Canada +1 866 984 3766 (866-9-Thermo) www.thermo.com

Europe: Austria +43 1 801 40 0, Belgium +32 2 482 30 30, France +33 2 2803 2180, Germany national toll free 08001-536 376, Germany international +49 6184 90 6940, Italy +39 02 02 95059 434-254-375, Netherlands +31 76 571 4440, Nordic/Baltic countries +358 9 329 100, Russia/CIS +7 (812) 703 42 15, Spain/Portugal +34 93 223 09 18, Switzerland +41 44 454 12 12, UK/Ireland +44 870 609 9203

Asia: China +86 21 6865 4588 or +86 10 8419 3588, India toll free 1800 22 8374, India +91 22 6716 2200, Japan +81 45 453 9220, other Asian countries +852 2885 4613

Countries not listed: +49 6184 90 6940 or +33 2 2803 2180

Thermo Fisher Scientific
401 Millcreek Road
Marietta, Ohio 45750
United States

www.thermofisher.com

ThermoFisher
S C I E N T I F I C