

Heating & Cooling Drybath

Digital Heating Cooling Drybath, 120 or 230V AC, 60 or 50/60Hz

Operation Manual 9240-11-020



Important Before using this product, read this entire operation manual carefully. Users should follow all of the operational guidelines contained in this manual and take all necessary safety precautions while using this product. Failure to follow these guidelines could result in potentially irreparable bodily harm and/or property damage. ▲

Caution All internal adjustments and maintenance must be performed by qualified service personnel. ▲

Material in this manual is for information purposes only. Thermo Fisher Scientific is committed to a continuing program of product development and improvement, and reserves the right to change information, such as specifications, appearance, and dimensions, described in this document without notice. Thermo makes no representations or warranties with respect to this manual. In no event shall Thermo be held liable for any damages, direct or incidental, arising out of or related to the use of this manual.

No part of this manual may be reproduced or transmitted in any form or by any means, including photocopying, recording, or using information storage and retrieval systems, for any purpose other than the purchaser's own use, without the express written permission of the manufacturer.

Any other product names and services identified in this manual are trademarks or registered trademarks of their respective owners. No such use, or the use of any trade name, is intended to convey endorsement or other affiliation with Thermo Fisher Scientific.





©2013 Thermo Fisher Scientific. All rights reserved.

MANUAL NUMBER 9240-11-020

0	--	12/19/13	Original	CCS
REV	ECR/ECN	DATE	DESCRIPTION	By

This manual contains important safety and operation information. You must carefully read, understand, and follow all the instructions in this manual prior to operating this instrument. Keep this manual in a safe place nearby for reference and make it easily available to all users.

- 1) This manual highlights DANGER/WARNING/CAUTION/NOTICE alerts to prevent injury or property damage and also to achieve optimum performance of your instrument.
- (2) These alerts are classified into four types in this manual depending on the importance and the risk levels as described below:

Symbols	Meaning
	Indicates a hazardous situation which, if not avoided, will result in death or serious injury.
	Ignoring this warning could cause serious injury or even death.
	Ignoring this caution could cause injury or property damage.
	Ignoring this notice could cause operational problems.

- 3) The claim which is out of the quality guarantee published by the Manufacturer is out of Manufacturer's responsibility.
- 4) The damage which is from unexpected fault or damage of user by Acts of God is out of Manufacturer's responsibility.

Do You Need Information or Assistance on Thermo Scientific Products?

If you do, please contact us 8:00 a.m. to 6:00 p.m. (Eastern Time) at:

1-740-373-4763	Direct
1-800-438-4851	Toll Free, U.S. and Canada
1-877-213-8051	FAX
http://www.thermoscientific.com	Internet Worldwide Web Home Page
service.led.marietta@thermofisher.com	Tech Support Email Address
www.unitylabservices.com	Certified Service Web Page

Our **Sales Support** staff can provide information on pricing and give you quotations. We can take your order and provide delivery information on major equipment items or make arrangements to have your local sales representative contact you. Our products are listed on the Internet and we can be contacted through our Internet home page.

Our **Service Support** staff can supply technical information about proper setup, operation or troubleshooting of your equipment. We can fill your needs for spare or replacement parts or provide you with on-site service. We can also provide you with a quotation on our Extended Warranty for your Thermo Scientific products.

Whatever Thermo Scientific products you need or use, we will be happy to discuss your applications. If you are experiencing technical problems, working together, we will help you locate the problem and, chances are, correct it yourself...over the telephone without a service call.

When more extensive service is necessary, we will assist you with direct factory trained technicians or a qualified service organization for on-the-spot repair. If your service need is covered by the warranty, we will arrange for the unit to be repaired at our expense and to your satisfaction.

Regardless of your needs, our professional telephone technicians are available to assist you Monday through Friday from 8:00 a.m. to 6:00 p.m. Eastern Time. Please contact us by telephone or fax. If you wish to write, our mailing address is:

Thermo Fisher Scientific
401 Millcreek Road, Box 649
Marietta, OH 45750

International customers, please contact your local Thermo Scientific distributor.

Table of Contents

Section 1	Warnings and Cautions	1-1
Section 2	Functional Descriptions	2-1
	Features	2-1
	Construction	2-2
Section 3	Installation	3-1
	Checking Instrument Components	3-1
	Installation Environment	3-1
	Location Conditions	3-2
	Checking Points	3-2
	Connecting to Main Power	3-2
	Instrument Plug-in	3-3
	Run/Stop	3-3
Section 4	Operation	4-1
	Setting Temperature	4-2
	Change Temperature During Operation	4-3
	Check Elapsed Time During Operation	4-4
	Stopping Operation	4-4
	Time Mode	4-4
	Setting T1 Timer	4-5
	Setting T2 Timer	4-6
	Checking Remaining Time During Timer Operation	4-7
	Stopping Timer During Operation	4-8
	Program Mode	4-8
	Starting Program	4-9
	Display During Program Operation	4-11
	Editing Program	4-12
	View Program Setting	4-14
	Stopping Program	4-15
	Confirming Program End	4-16
	Resetting All Program	4-16
	Resetting Individual Program	4-16
	How to Replace a Block	4-17
	Offset	4-19

Section 5	Safety Device	5-1
Section 6	Maintenance	6-1
	Cleaning the Main Body6-1
	Cleaning the Accessories6-1
	Relocation6-2
	Keeping Product6-2
Section 7	Troubleshooting	7-1
Section 8	Accessories	8-1
Section 9	Technical Specifications	9-1
	Disposing of the Product9-2
Section 10	Warranty Information	10-1

Section 1 Warnings and Cautions

WARNING

Ignoring the following warnings could cause serious injuries or even fatal accidents.

Case of explosive and flammable chemicals, you must use with sufficient safety countermeasures.

In accordance with experiment, you should install safety devices and should follow suitable regulations in your laboratory.

Do not install the product in the place that the gas could leak out. Do not use in a place that has industrial oil smoke and metallic dust. It causes fire or electric shock.

Do not use the machine near places where explosion can occur due to organic evaporating gases.

Explosive materials: Acid, Esther, Nitro compound

Inflammable materials: salt peroxides, inorganic peroxide, salt acids.

Do not use the machine at places where moisture is high and flooding can be happened.

Check electrical requirements described in this operation manual or on the ID plate of this instrument before use.

Connect this instrument to a dedicated power outlet nearby.

Make sure to connect this instrument only to properly grounded power outlets to protect you and your instrument. Do not ground to gas pipes or water pipes.

Unplug if there is a strange sound, smell or smoke from the product. Stop operating and request service.

Do not assemble, repair, modify on your own. The product may not work well and electric shock could change the efficiency of the product. Also this will void the warranty.

Section 1

Warnings and Cautions

CAUTION

Indicates a hazardous situation which, if not avoided, may result in minor or moderate injury.

Do not touch block immediately, even power off. Because the block might be have Residual heat. It may be cause burns from high temperature of block, seemingly invisible.

Do not forget plugging off, after product main switch off. It is safety regulations for the next user.

Do not put heavy things on the power line. Do not put the machine on the line. It may take off the wire coating and cause electric shock or fire.

Do not touch it with wet hands. It may cause the electric shock or injuries.

Do not pour or insert any inflammable materials into the product.

Do not pour water or put liquid on the top of the product when cleaning. Intercept the main power immediately and request the service when water may be in the product.

Do not let the product take any strong shock or vibration. It causes abnormal operation or trouble. It may deteriorate the ability of the product and not obtain correct results.

Do not install the instrument near strong electric field exposed environment.

Use caution, the pace maker or magnetic recording instrument might be influenced by our instruments and magnetic stick.

Do not sprinkle insecticide or flammable spray on the product. Use smooth cloths. Cleaning with solvent can cause fire and deformity.

Power off while product cleaning. It may cause the electric shock or fire.

Section 2 Functional Descriptions

Digital Cooling Drybath is designed for high heat conductivity and fast heating rate by peltier module with 200W Heater.

General application follows that;

- Enzyme reaction
- Enzyme kinetics
- Immunoprecipitation kinase assays
- Sample incubation and reaction
- RNA transcription
- DNA analysis
- Genetic analysis – extraction of DNA, RNA and further sample preparation

Features

Performance

- Precision accuracy is ensured (0.1°C) by its PID controller.
- Operation control range :
Available to use heating and cooling with provided wide temperature control range: 20°C below ambient ~ 95°C.
- Using a peltier module offers fast temperature approaching.
- Users can conveniently set timer operation (1min ~ 99hour 59min). Two kinds of timers are provided for proper uses. Also, the timer can be checked for remaining time and resting. [Refer to Timer Modes in Section 4.]
- Provide program modes that users can schedule as their experiment protocols.
 - Up to 10 programs allowed for memory storage. And each program can be set by maximum 10 steps temperature control functions.

Safety

- Designed with water-proof structure that minimizes influx of reagents or solution.
- Designed with threefold safety system to cut off main power; overheating protection for heater, overheating protection for circuit, and over-current protection circuit structure.
- Polypropylene (PP) material block covers decrease chances of accidental injuries.

Features (continued)

Ease of Use

- Available to use 0.5ml, 1.5ml, 50ml tube block. [Refer to Accessories section].
- Easy to check a set temperature value and operating conditions through VFD (Vacuum Fluorescent Display).
- Convenient to control the product by Touch Button and Dial Knob.
- The main body is made of polypropylene (PP). Polypropylene (PP) is resistant to chemicals and easy to clean.

Construction

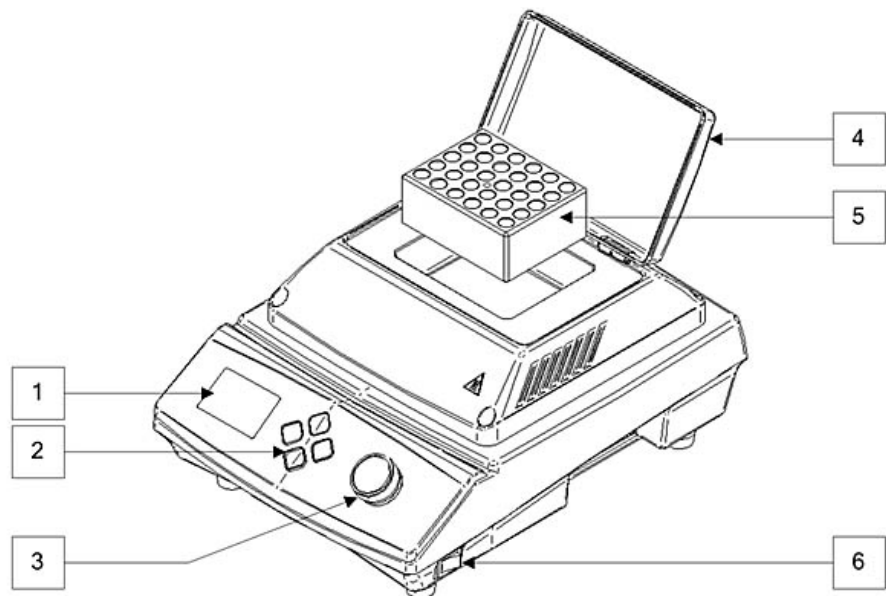

- (1) VFD (Vacuum Fluorescent Display): To display operating status.
- (2) Touch Button: To choose temperature and time
- (3) Dial Knob: To set a temperature value and time
- (4) Lid: User can indicate sample state during heating, and uniform temperature distribution.
- (5) 1.5ml tube block (optional): 0.5ml, 15ml, 50ml tube blocks can be used. [Refer to Accessories section.]
- (6) Power Switch: Power should be ON/OFF.

Construction (continued)

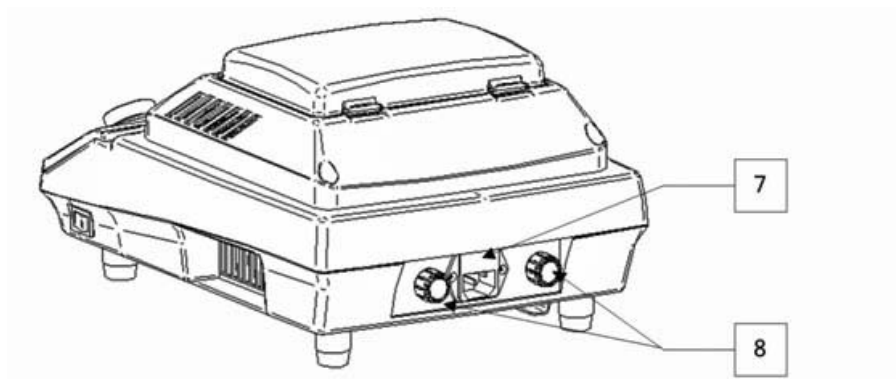

(7) Socket: Connecting the power cable into the socket.





(8) Block Lifter: Used during block exchange (refer to Section 4).

Section 3 Installation

Check to see if there is any damage in the instrument packaging before unpacking. Then unpack the instrument carefully. Inspect to see that the instrument was not damaged during transportation.

Checking Instrument Components

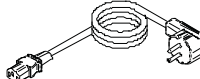
Check the instrument components supplied in the package after unpacking. If a noticeable issue or an omission is found, immediately notify your local Thermo Scientific dealer's Service Department.

BASIC COMPONENT	FIGURE	QUANTITY/ RECEIVED	DESCRIPTION
Main body		1	-
Block Lifters		2	-
Power cord		1	-
Operating manual		1	-

Installation Environment

The unit should be installed in a suitable environment as described below.



Avoid direct sunlight.



Room temperature should be 5°C ~ 30°C



Relative Humidity (RH%) should be less than 80%.



Altitude should be less than 2,000m.

Location Conditions

Place the instrument far from the other instruments and keep the proper distance (normally more than 30cm).

⚠ WARNING

- Place and install the instrument on a stable fireproof surface with non-slip and non-moisture and avoid direct sunlight & heat.

Checking Points

- Unit should be used on a flat working table with safety facility.
- Unit should not be used where a combustible gas leak might occur.
- Unit should not be used in high electric field environments.
- Unit should not be used in dangerous places of electric leakage, water leakage, and submersion.
- Unit should not be used where there are industrial harmful gases or metal dusts.

Connecting to Main Power

Connect the electric power to the unit according to the following process.

- (1) Switch off the main switch before connecting the power cable.
- (2) Connect the power cable to the socket of the main body and to the power supply.

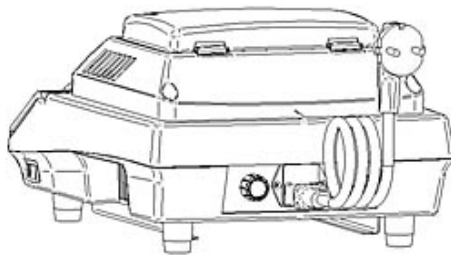

⚠ WARNING



Electrical Shock Hazard

- Ensure that the instrument is connected to an appropriate power supply in terms of voltage, phase and capacity.
- Use a grounded power source.
- Never use a forked socket, or a double-tapped socket.
- Failure to obey a safety warning will cause a drop in a line voltage, resulting in a loss of power and causing risk of fire by turning the cable.
- Do not handle or touch electric codes and devices with wet hands.
- Wrong power supply can cause serious damages to the instrument and body; even to death.

Instrument Plug-in

When you switch on, the instrument displays as below.

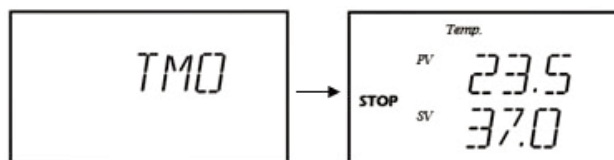

NOTICE

- Touch Buttons are displayed with green or red colored backlight. When a backlight color of a button is green, the button is valid so that it can sense user's touches to itself. When it is red, it cannot sense the touches of users.
- When the instrument is powered on, the fan starts operating.
- Before displaying the temperature, the instrument needs start-up latency time shortly.

Run / Stop

You can operate or stop the instrument by pressing START/STOP.

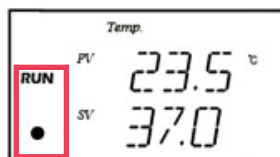

[Display when Heater is on]

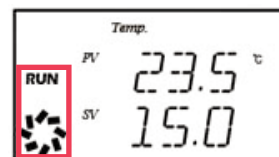

[Display when Cooler is on]

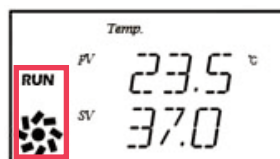

[Display: Heater and Cooler are on]

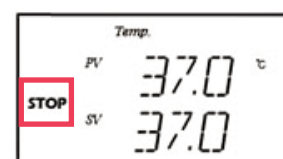

[Display: Heater and Cooler stop]

NOTICE

- If you set temperature less 50°C, Cooler and Heater work at the same time.
- If you set temperature over 50°C, Only Heater works.
- There might be some noises when Fan or Cooler works.



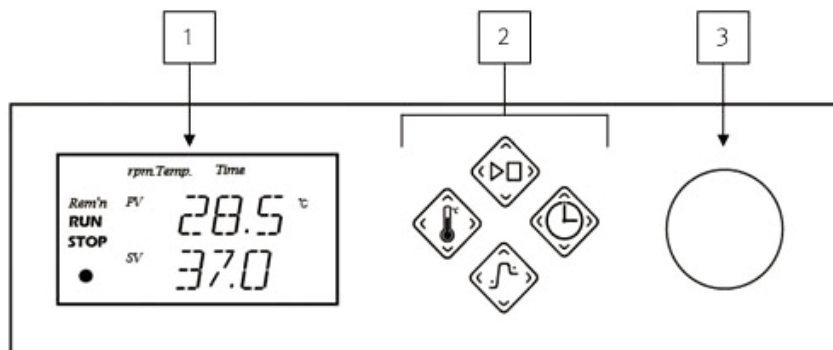

Section 4 Operation



(1) VFD (Vacuum Fluorescent Display): Check setting temperature and current state of operation.

A	<i>Rem'n</i>	Remaining time during operation
B	RUN	Indicates the instrument is operating
C	STOP	The instrument is stopped
D	●	Indicates heater is working.
E	⊗	Indicates cooler is working
F	<i>PV</i>	Process Value (Current value)
G	<i>SV</i>	Set Value (Target value)
H	<i>Temp.</i>	Indicate temperature is now displayed.
I	<i>Time</i>	Indicate time (elapsed time or remaining time) is now displayed or timer is operating.

(2) Touch buttons:

A		START/STOP	Start and stop the instrument. Go back one step when setting parameters for operation.
B		TEMP	Set temperature. Go into Offset setting.
C		PROGRAM	Step into the program mode.
D		TIMER	Set timer function. Check remaining time or elapsed time.

3) Dial knob: It can be used when setting temperature, timer and program parameters.

Setting Temperature

(1) Press TEMP when the instrument is on stand by.



(2) You can set temperature by adjusting Dial Knob with 0.1°C resolution (e.g., change the SV from 23.5°C to 60.0°C)

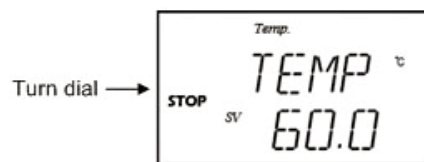

At any time, you can exit out of temperature set mode by pressing START/STOP.

(3) Pushing Dial Knob, you can save the target temperature as a temperature SV(Set Value).



Setting Temperature (continued)

(4) Then you can operate it by pressing START/STOP.

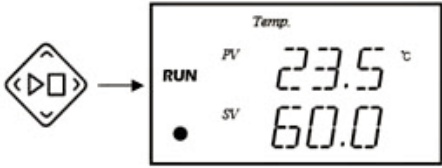

NOTICE

- To step back from temperature setting, press START/STOP. The instrument returns to standby.
- You can also change the temperature SV when the instrument is in operation. [Refer to Change Temperature During Operation]
- The instrument keeps the temperature after the temperature PV reaches to its SV by repeating heater and cooler on and off.
- SV of temperature is updated to the last set value. This will not be initialized even after Power Switch off and on.
- You can set Offset by pressing TEMP during operation.

CAUTION

- The instrument and its accessories can be hot even though the Power Switch is off.

Change Temperature During Operation

It is possible to change a target temperature by pressing TEMP during operation. Change the temperature SV by adjusting dial knob and you can start it by pushing dial knob.

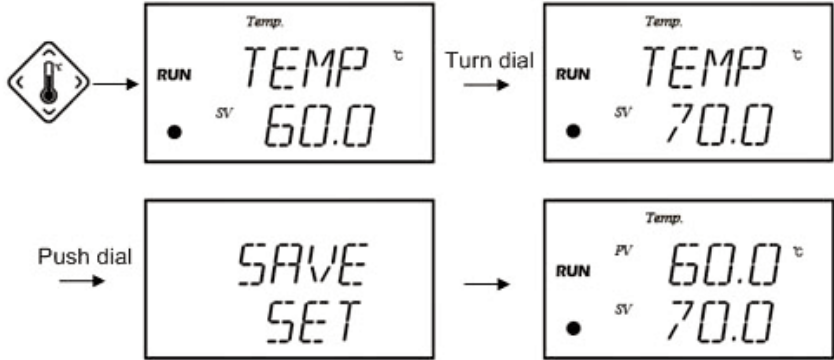

NOTICE

- You can escape from the temperature changing process by pressing START/STOP or leaving it without additional input for 10 seconds.

Check Elapsed Time During Operation

Elapsed time for operation can be checked by pressing TIMER once when the instrument is in operation.

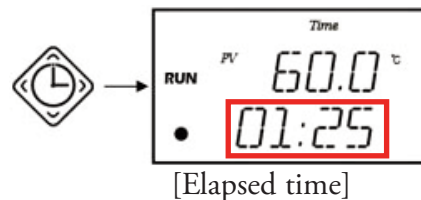

To step back from the elapsed time check, press START/STOP or leave the instrument for 10 seconds.

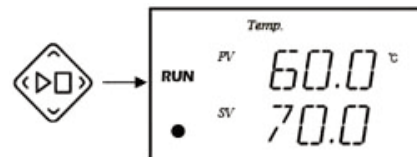

Stopping Operation

Press START/STOP during General Mode operation. The instrument will stop operation.

CAUTION

- Instrument and its accessories can be hot even though power switch is off.

Timer Modes

This instrument provides two types of timers (T1 and T2 timer). The timers are different in a operating condition and point of time countdown.

T1 timer	T2 timer
Set when heating control is operating	Set when heating control is not operating
Start counting down the timer immediately	Start counting down the timer just after it reaches temperature SV

NOTICE

- Timer can be set from 1min~99h 59min.
- Exit the timer setting mode by pressing START/STOP repeatedly.
- T1 timer starts counting down when set the timer, immediately and "Time" in VFD blinks.
- T2 timer starts counting down when temperature reaches to SV and "Time" in VFD blinks.
- Elapsed time can be checked by pressing TIMER once and get into T1 timer setting by pressing TIMER twice during temperature control operation.
- After a timer counting is finished, the cooler starts to make the instrument temperature converge to the room temperature.
If the user confirms the end of the timer operation by using touch buttons or dial knob, then the cooler does not operate and the instrument returns to standby state.

Setting T1 Timer

T1 timer is for setting a timer during temperature control operation. It also requires SVs for temperature and time.

In T1 timer mode, regardless of reaching the temperature SV, the timer starts to count down just after the timer setting.

- (1) Press TIMER twice during temperature control operation.

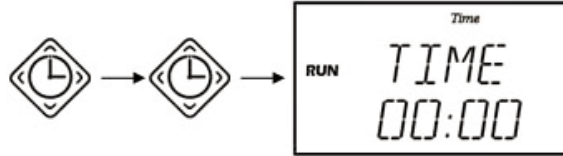

- (2) Select a desired time by using Dial Knob in the order of hour, minute.
You can set the timer from 1min to 99h 59min.

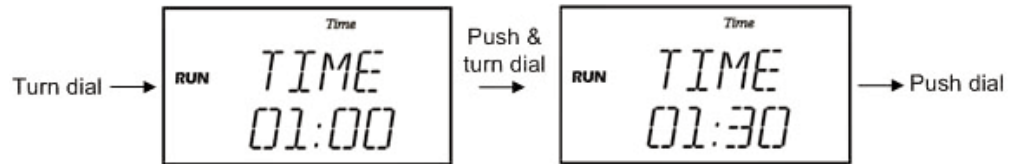

- (3) Input a target temperature by using Dial Knob and save it by pushing Dial Knob.

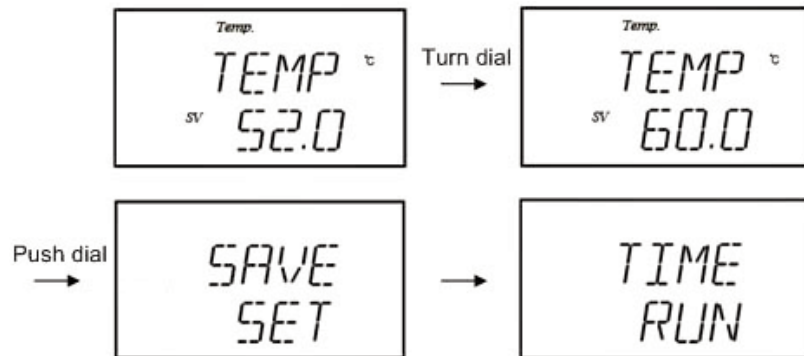

- (4) When the timer operation ends, the instrument generates a sound alarm with a display as follows. Confirm the end of the timer operation by using Touch Buttons or Dial Knob.

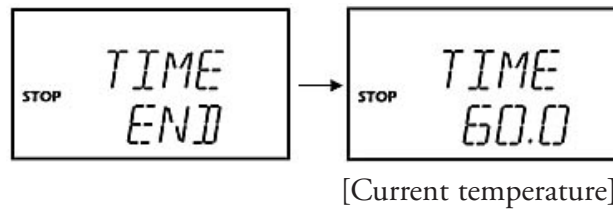

Setting T1 Timer (continued)

NOTICE

- Every set target time(time SV) is memorized as an initial value of timer. You can see the last set time SV when setting a new time SV, as an initial value.
- During the timer operation, you can stop the instrument by pressing START/STOP. [Refer to Stopping Timer during Operation in this section.]
- During timer setting, the instrument returns to standby if you leave it for about 10 seconds without saving the time value.

Setting T2 Timer

T2 timer can be set only when the instrument stops temperature control. After setting T2 timer, the temperature control starts operating to make the temperature PV the same to the temperature SV. When its temperature reaches to the temperature SV, the timer starts to count down.

- (1) Press TIMER when the temperature control is not operating.



- (2) Input Hour, Minutes by using Dial Knob.
(Timer range: 1min ~ 99hour 59min)

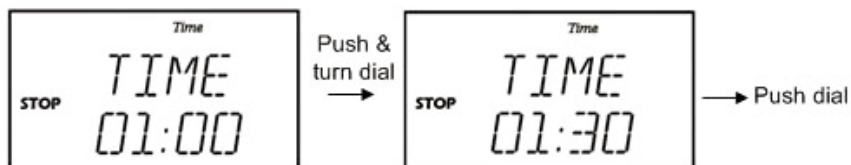

- (3) Input a target temperature by using Dial Knob and save it by pushing Dial Knob. In case of that you do not change the temperature SV, just push Dial Knob.

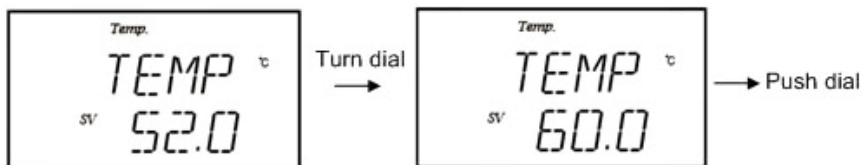

**Setting T2 Timer
(continued)**

(4) Select whether start operating the instrument or not by using Dial Knob.

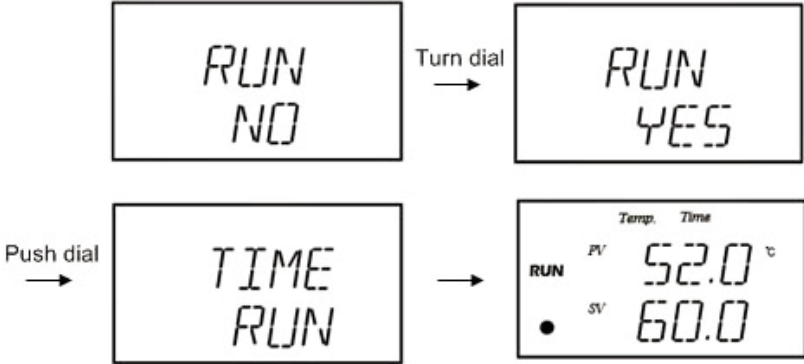

When it reaches to the set temperature, the timer starts with a sound alarm.

(5) When the timer operation ends, the instrument generates a sound alarm with a display as follows. Confirm the end of the timer operation by using Touch Buttons or Dial Knob.

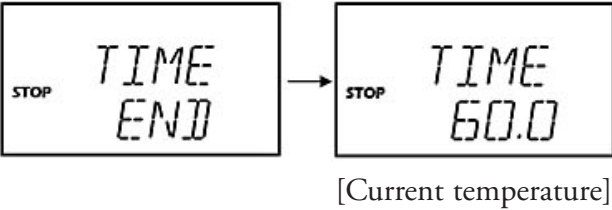

NOTICE

- If you press Dial Knob in "RUN NO", all inputs for T2 timer are canceled and the instrument returns to stand by.

**Checking Remaining Time
During Timer Operation**

Remaining time for timer operation can be checked by pressing TIMER once when the instrument is in operation.



[Remaining time]

During the checking process, you can escape from the process if you press START/STOP or leave the instrument without additional input for 10 seconds.

Stopping Timer During Operation

You can stop the operation by pressing START/STOP.

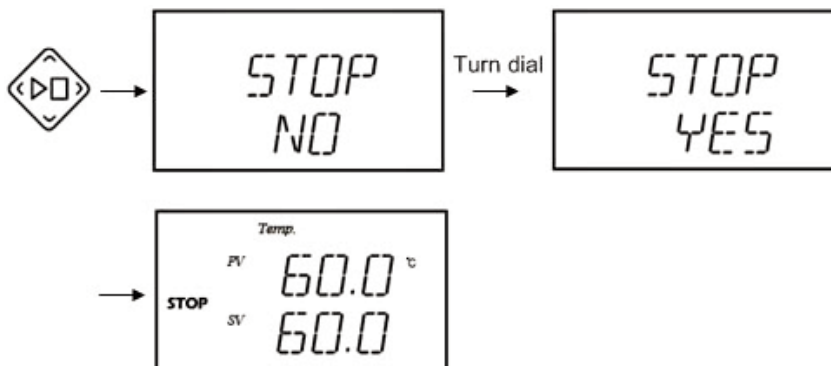

Confirm the end of the timer operation by using Touch Buttons or Dial Knob.

CAUTION

- The instrument and its accessories can be hot even though the Power Switch is off.

Program Mode

This instrument provides 10 user-programmable programs. Each program consists of steps (maximum 10 steps) that have parameters including temperature SV and time SV (step duration).

It also provides a looping function that repeats a program as many times as user selected (range: 1~99, infinity).

[Diagram of Program Mode]

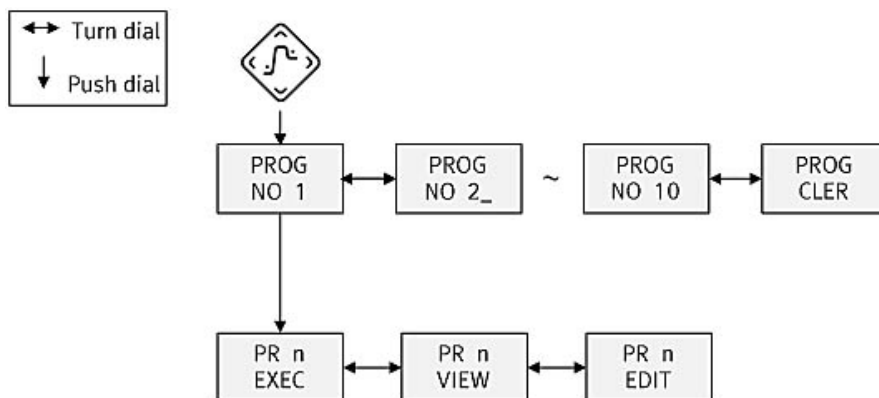

ABBREVIATIONS	Descriptions
PROG (PR)	Program
EXEC	Run a program
VIEW	View configurations of a program
EDIT	Edit configurations of a program
CLER	Clear all programs or a program.

Program Mode (cont.) [Temperature control in Program Mode]

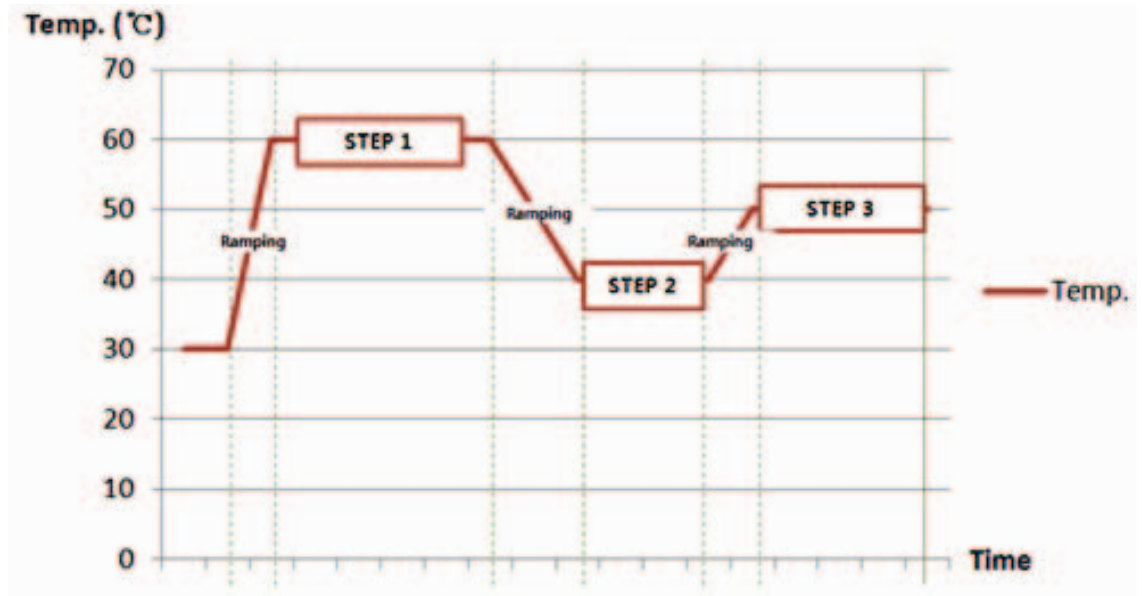

NOTICE

- A time SV for a step starts to be counted just after the instrument temperature reaches to the temperature SV of the step.
- If the time SV for a step is set as "00:00", then the step will be skipped and the next step will proceed.
- It is possible to repeat a program from 1 to 99 times or infinitely.
- The operation of a program mode can be stopped by pressing START/STOP. [Refer to Stopping Program in this section.]
- Saved programs can be repeated from 1 to 99 times or infinitely.

Starting Program

(1) Press PROGRAM when the instrument is on standby.



(2) Select a program by turning and pushing the Dial Knob.



Starting Program (continued)

- (3) Select a program execution “PR n EXEC” by pushing Dial Knob (n:program number).



- (4) Select the repetition loop number and operate the program by turning the Dial Knob.

- Turn Dial Knob to the right : You can select the number of repeats from 1 to 99.
- Turn Dial Knob to the left : Repeat the program infinitely.



[In case of repeating 5 times]



[In case of repeating infinitely]

Display During Program Operation

During program mode operation, the instrument displays its operating status, “program number and current step” → “remaining time of current step” or “the current number of repeats in infinite loop” or “the current onumber of repeats and total number repeats” → “process value and set value for temperature”.

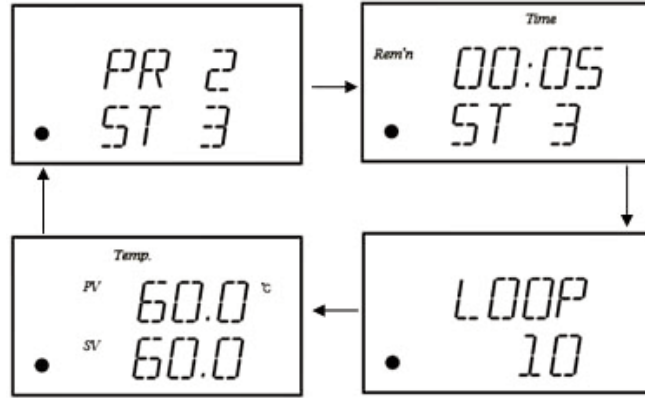

[Program 2 and step 3] → [remaining time: 5min and step 3] → [10th iteration of infinite loop] → [temperature – PV: 60°C, SV: 60°C,

In case of ramping periods between two different steps, the display for remaining time is replaced to alternative displays indicating that the instrument is on temperature ramping.

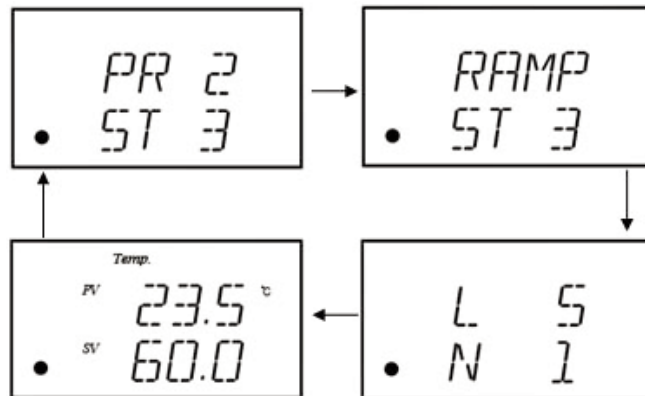

[Program 2 and step 3] → [ramping to step 3 temperature] → [1st iteration of 5 total repeats] → [temperature - PV: 23.5°C, SV: 60°C,

Editing Program

- (1) Press PROGRAM when the instrument is on standby.



- (2) Select a program you want to edit by turning and pushing Dial Knob.



[In case of editing program no.2]

- (3) Select a program execution "PR n EDIT" by turning and pushing Dial

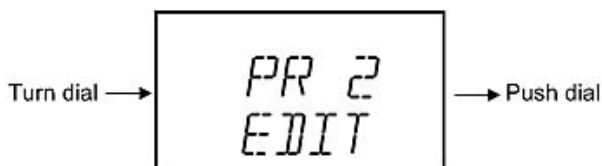

Knob as below (n: program number).

- (4) Enter the number of steps for the program. You can set up 10 steps for a program.

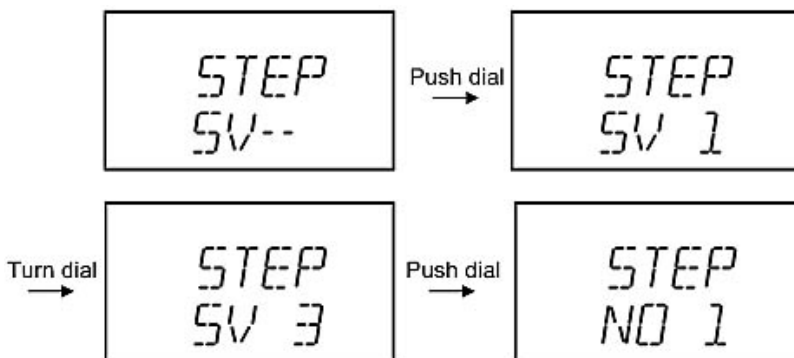

[In case of setting 3 steps for program 2]

- (5) The program is reset and generates new steps as many as step SV. Then you can set SVs for temperature and time for each step by using Dial Knob.



Editing Program (continued)

- (6) Enter the target temperature and time for the step, and then save the entered value (SVs) as below.

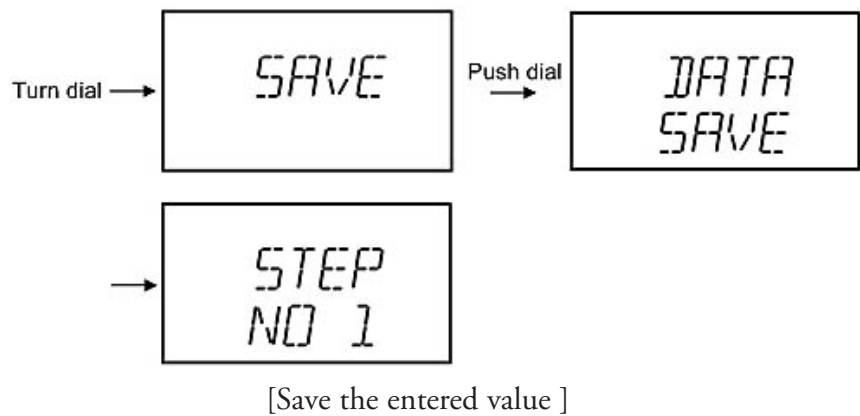
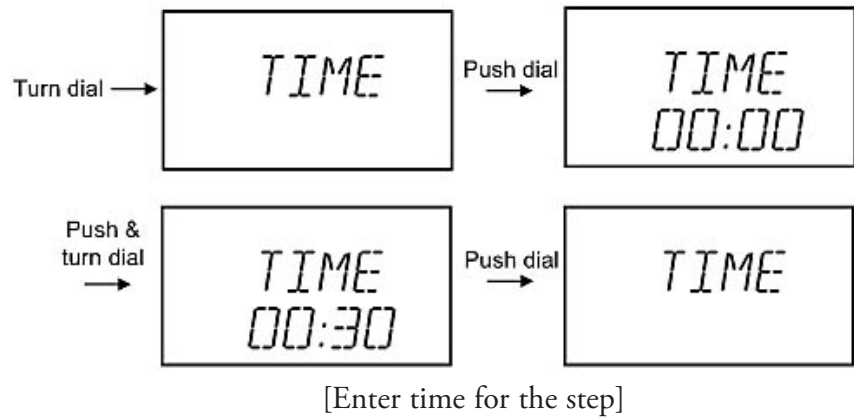
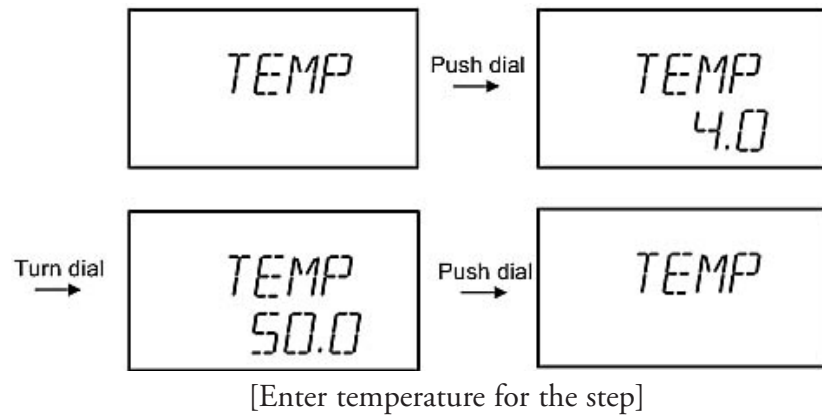

If you skip the saving process, all entered inputs are not saved.

By applying (5) and (6) for every step, you can complete program editing.

Editing Program (continued)

(7) After saving all generated steps, push START/STOP to escape program editing.

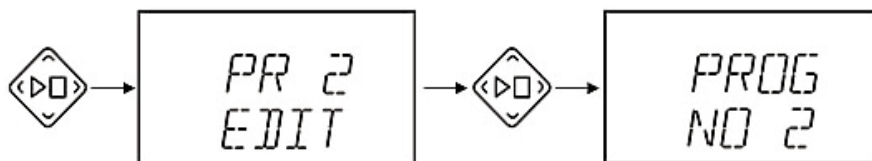

NOTICE

- If you want to write a new program on a program slot, set step size of the program slot. The step size setting includes clearing existing program and initializes a new program. [Refer to Reset Individual Program]
- Just after you set the step size for a program, each step has 4°C for temperature and 00:00 for time as initial values. This instrument is supposed to skip steps that have 00:00 for time. So, non-edited steps will be skipped in program execution.
- Temperature setting range for this instrument is 4°C~95°C, Recommended temperature control range is from 20°C below ambient to 95°C.
- When program operation ends, Cooler automatically operates until the temperature goes down to room temperature. If you confirm the end of the program by using Touch Button or Dial Knob, Fan stops and the instrument become standby.

View Program Setting

(1) Press PROGRAM when the instrument is on standby.



(2) Select a program you want to view by turning and pushing Dial Knob.



[In case of viewing program No.2]

(3) Select a program execution "PR n View" by turning and pushing Dial Knob as below (n: program number).

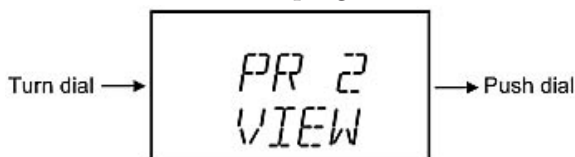

View Program Setting (continued)

- (4) Turn Dial Knob to find a specific step you want to view. Push Dial Knob to get into the step.



[In case of viewing step No.3]

Then the SVs of temperature, time and RPM for the step can be viewed.

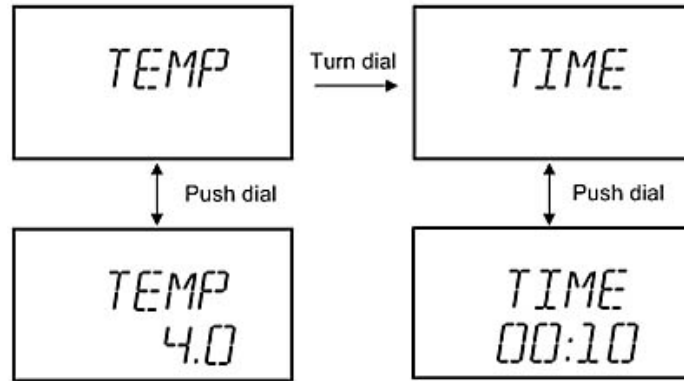

- (5) After viewing the program setting, move out by using START/STOP.

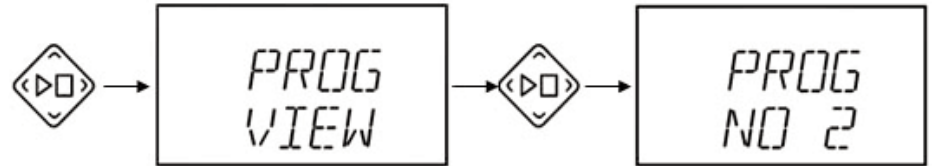

Stopping Program

By pressing START/STOP, you can stop program operation.

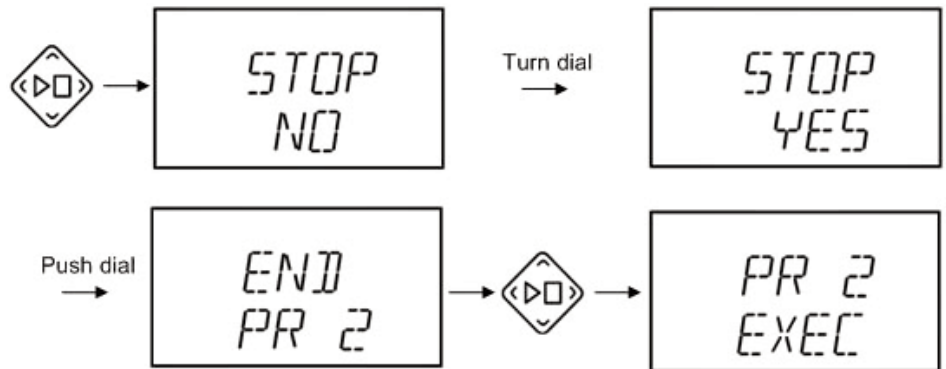

Confirming Program End

“END PR n” is displayed with sound alarm at the end of a program (n: program number). Check the program end by pressing START/STOP.

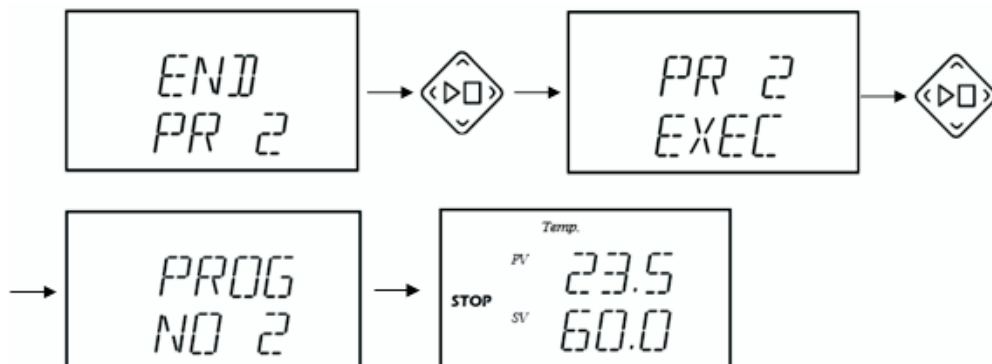

Resetting All Program

(1) Press PROGRAM at standby.



(2) Turn Dial Knob to the right end and select “PROG CLER”.

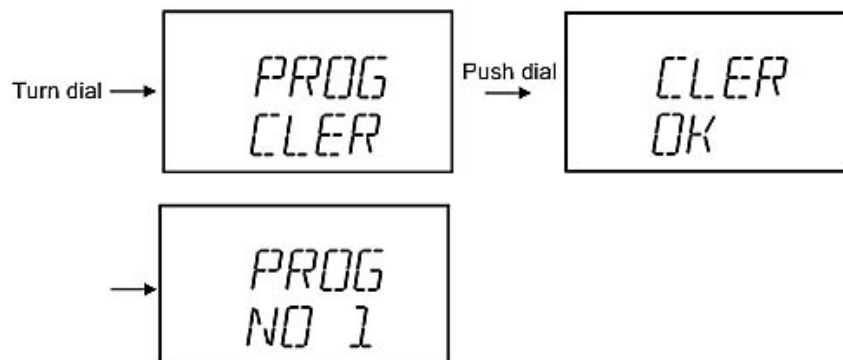

All programs are initialized. It takes some time for resetting all programs.

Resetting Individual Program

(1) Press PROGRAM at standby.



Resetting Individual Program (continued)

(2) Select a target program that needs to be deleted.



[In case of resetting program 2]

(3) Turn Dial Knob to the right and push “PR n EDIT” (n: program number).



(4) Turn Dial Knob to the right end and press Dial Knob at “STEP CLER”.

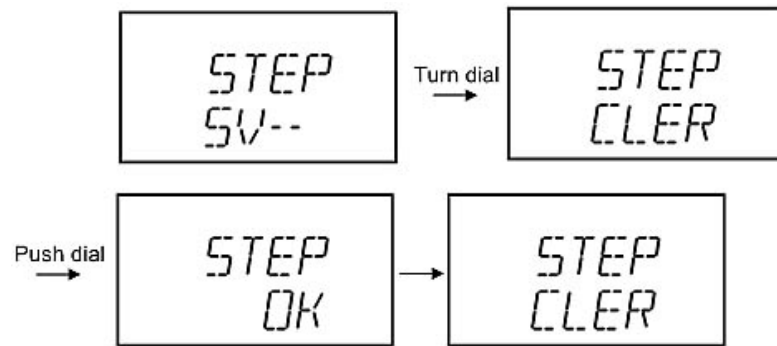

All previous steps of the program are deleted.

NOTICE

- Setting a step size (“STEP SV”) for a program includes resetting the previous program and generating new steps as many as the set step size.

How to Replace a Block

(1) Remove block lifter from the back of the instrument by turning the block lifter in a counter-clockwise direction.

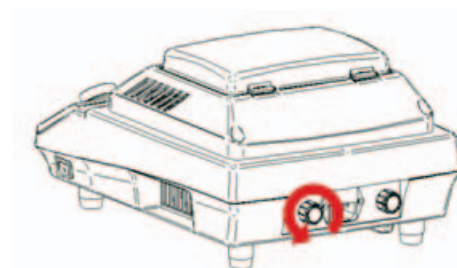

How to Replace a Block (continued)

- (2) Fix the detached block lifter to a hole in the middle of a block, by turning it clockwise as below.



- (3) Detach the block by lifting it up from the instrument in a direction of an arrow shown as shown below.



- (4) Insert a new block into the instrument through using the block lifter in the same way as above.

⚠ CAUTION

- Before replacing a block, detach tubes, vials, microplate etc. from the block.
- You should be careful in handling the instrument. Blocks and main body of the instrument can be hot even after the Power Switch is off.
- Make sure that blocks and block lifters are inserted correctly.

Offset

The temperature shown on the VFD is measured by a temperature sensor inside the instrument. However, this temperature can be different from the temperature of your own thermometer which you may use as a standard for your specific applications. If needed, you can offset such temperature differences within the range of $\pm 50^{\circ}\text{C}$ at 0.1°C interval.

The temperature offset setting procedures are as follows:

- (1) Turn the power on.

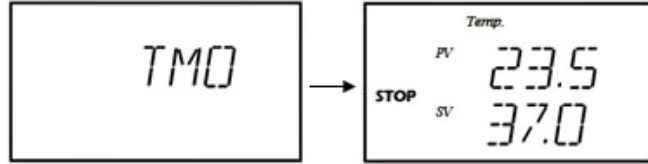

- (2) Press TEMP until the following temperature offsetting screen appears with audible alarm.



- (3) Select the offset value by turning the Dial Knob appropriately and, when selected, save it by pushing Dial Knob. When properly saved, the save confirmation screen will appear as shown below:

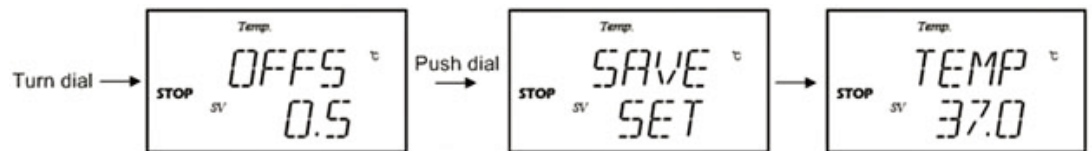

[Offset value selection 0.5°C ,

- (4) After confirm saving offset, setting a SV temperature is automatically displayed as below. Finally, it returns to standby state with PV that offset is applied to and the changed SV.

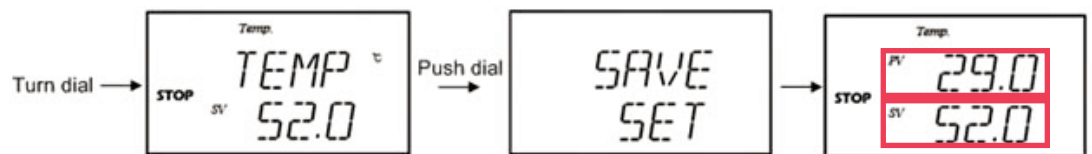

[Save setting temperature 52.0°C]

Offset (continued)

If you press START/STOP or leave the instrument for about 15 seconds in this step, then it returns to standby and you can see that PV is affected by the offset.

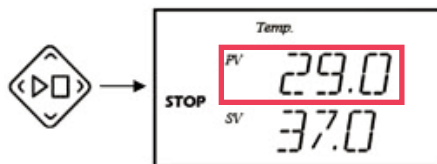

NOTICE

- You can except the offset by pressing the START/STOP during offset input.
- During operation, you can set offset by pressing TEMP.

Section 5 Safety Device

- (1) The overheat protection device for the block.
The power of this instrument automatically cuts off when the block's temperature overheats more than 115°C, to protect the instrument.
- (2) The circuit protection device.
The power automatically switches off when the circuit's temperature overheats in a certain degree which will activate this device to protect the circuit inside of the instrument.
- (3) The overcurrent protection device.
The power automatically switches off when the current flows more than the given current value which will activate this device to protect the instrument.
- (4) Overheating / undercooling protection system
In case that the sensed temperature is over 140°C and it maintains for 15 seconds, Err2(Error 2) is displayed on the screen with a beep and temperature control stops.
In case that the sensed temperature is less than -5 °C and it maintains for 15 seconds, Err3(Error 3) is displayed on the screen with a beep and temperature control stops.

NOTICE

- The instrument should be used after fully cooling it down when the instrument is switched off by these kinds of the protection devices.

Section 6 Maintenance

Classifications	Checking Time Period	
	Daily	Weekly
Power cord		
- The conditions of connection for power supply and an adaptor	•	
- The presence of power supply and an adaptor contact wetting, and cable peeling off, and out of contact	•	
Product surface cleaning		•
Block clean condition	•	
Controller function checking	•	
Check accessory attachments to the instrument are tight	•	

Cleaning the Main Body

Remove a contaminant by cleaning the instrument frequently with a soft cloth before and after using, otherwise it cannot be readily wiped out for a long time. Keep the unit clean always, without any contaminants.

CAUTION

- Do not put under the water.
- Do not damage inside of accessories and system. Use caution.
- Do not touch product with a high concentration of nitric acid, sulfuric acid, sodium hydroxide, acetone, benzene, phenol, toluene, chloroform, cresol, acetic acid series, and chlorine series corrosive solvent.
- Separate power cord from body, if not in use.
- Do not use chlorine bleach, ammonia-based cleaners, abrasives, ammonia, or metal scouring pads when cleaning.

Cleaning the Accessories

Remove a contaminant by cleaning the instrument frequently with a soft cloth before and after using, otherwise it cannot be readily wiped out for a long time. Keep the instrument clean always, without any contaminants.

Relocation

- (1) Disconnect the power cord from the power outlet.
- (2) Pack the instrument and its accessories into the original packaging or any other suitable container before moving.

CAUTION

- Pay attention to avoid mechanical shock or vibration while moving instrument. Damages caused by mechanical shock or vibration may result in injury or fire.

Keeping Product

- (1) Unplug the instrument from the main power.
- (2) Clean the instrument with a soft cloth neatly.
- (3) Store in a dry place after packing.





Section 7 Troubleshooting

Electrical Trouble	Causes	Solution
The unit does not turn on	Incorrect electric power	Compare power source and voltage on the ID plate and make sure they are the same. ID plate is found on the back of unit.
	Power failure or circuit breaker shuts down	Find out the causes of power failure and recovery.
	Main plug not seated properly.	Check the electrical cord connection at the unit to ensure it is fully seated.
	Check the electrical cord connection at the unit to ensure it is fully seated.	If the socket / plug / main power line are cut, request service.
	PCB has damage by reagent	Request service.
Room circuit breaker trips often when the unit is turned on or running	Too many plugs connect at the same time	1. Check the circuit breaker size along with the voltage and current supplied to it. 2. Check that several similar units are inserted together, if so, you should not use overly.
	Product inner circuit problem	Request service.
No VFD	Power failure	Find out the causes of power failure and recovery.
	Main plug not seated properly.	Check the electrical cord connection at the instrument to ensure it is fully seated.
Button doesn't operate well	Power failure	Find out the causes of power failure and recovery.
	Button switch has damage	Request service.

Section 7
Troubleshooting

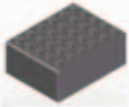
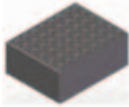
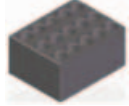
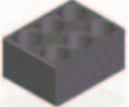
Troubles During Operation	Cause	Action
Block is not heating up.	START/STOP is not pressed.	Press START/STOP on the control panel.
	Set temperature is lower than present temperature.	Check set temperature and adjust it properly.
	Heater failure	Request service.
	Circuit protection device cut off the power.	Take off the cord for cooling down the instrument and re-start it.
	Product internal circuit problem	Request service.
Error 2 or Error 3 is displayed	1. Temperature sensor problem 2. Board problem	1. Turn the power off and on after certain period of time 2. Request service
The Dial knob isn't operating correctly.	Dial knob or circuit problem	1. Pull out the knob from the instrument and replace it again. 2. Request service.
Error message on the display	Product internal circuit problem	Request service.
The VFD lamp is not operating.	Product internal circuit problem	Request service.

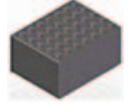
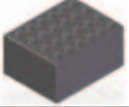
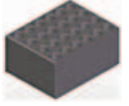
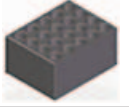
Section 8 Accessories

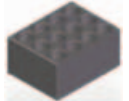
Designation			Order No.	Description (Dimension: W x D x H, mm)	
Block 1.5 microtube	1.5ml x 30		88880130	98 x 76.5 x 41	You can close or open instrument cover, when using these blocks.
Block 0.5 microtube	0.5ml x 48		88880129	98 x 76.5 x 41	
Block 15 centrifuge tube	15ml x 15		88880131	98 x 76.5 x 51	You cannot close instrument cover, when using these blocks.
Block 50 centrifuge tubes	50ml x 6S		88880132	98 x 76.5 x 51	
Block 50 centrifuge tube t	50ml x 6T		88880133	98 x 76.5 x 87	
Block Ø10mm	Ø10 x 35		88880134	98 x 76.5 x 51	
Block Ø12mm	Ø12 x 24		88880135	98 x 76.5 x 51	
Block Ø13mm	Ø13 x 24		88880136	98 x 76.5 x 51	
Block Ø15mm	Ø15 x 20		88880137	98 x 76.5 x 51	
Block Ø16mm	Ø16 x 16		88880138	98 x 76.5 x 51	
Block Ø18mm	Ø18 x 12		88880139	98 x 76.5 x 51	
Block Ø20mm	Ø20 x 12		88880140	98 x 76.5 x 51	

Section 9 Technical Specifications

Heating & Cooling Block		Digital Cooling Drybath
Temp	Control range (°C/°F)	Amb. -20 to 95 / Amb. -36 to 203 (Feedback Control PID)
	Setting Range (°C/°F)	4 to 95 / 39.2 to 203, 0.1°C resolution
	Uniformity (±°C/°F)	0.55 / 0.99 (at 37°C)
	Stability (±°C/°F)	0.15 / 0.27 (at 37°C)
	Heater output, max. (W)	200
	Peltier output, max. (W)	160
	Function	Offset
Program		10 memories, 10 steps/memory
Timer		1min to 99 hr 59 min
Safety Device		Over temperature protection, Over current detection
Control Panel		VFD (Vacuum Fluorescent Display), 4 Touch keys, Dial knob
Material	External	PP, PC, Powder coated steel
	Block	Black anodized Aluminum
Dimension	Internal (mm/inch)	99 x 77.5 x 36 / 3.9 x 3.1 x 1.4
	Overall (mm/inch)	249 x 330 x 168 / 9.8 x 13 x 6.6
Net weight (kg/lbs)		5.0 / 11.0
Electrical requirements (120V/60Hz, A)		4
Electrical requirements (230V/50/60Hz, A)		2
Exchangeable blocks		1.5ml x 30, 0.5ml x 48, 15ml x 15, 50ml x 6S, 50m x 6T, Ø10 x 35, Ø12 x 24, Ø13 x 24, Ø15 x 20, Ø16 x 16, Ø18 x 12, Ø20 x 12

** Specifications can be changed without prior notice for quality upgrade.*

** Permissible ambient condition: 2-60°C, Relative humidity up to 80%.*

Disposing of the Product



Before disposing of the shaker or any of its components:

1. The instrument should be cleaned and decontaminated to protect workers servicing the instrument, the environment or the public purchasing surplus instrument because the shaker can potentially be contaminated with biological material, chemicals or radioisotopes. Check with your institution or laboratory for individual policies and procedures for disposal of laboratory instrument.
2. Please contact your local governing body for regulations regarding disposal of electrical, electronic, metal (brass, aluminum, steel and stainless steel), refrigeration and rubber components. Thermo Scientific recommends the user find a local scavenger or laboratory instrument recycler to properly dispose of the instrument and its components.

THERMO FISHER SCIENTIFIC STANDARD PRODUCT WARRANTY

The Warranty Period starts two weeks from the date your equipment is shipped from our facility. This allows for shipping time so the warranty will go into effect at approximately the same time your equipment is delivered. The warranty protection extends to any subsequent owner during the first year warranty period.

During the first two (2) years, component parts proven to be non-conforming in materials or workmanship will be repaired or replaced at Thermo's expense, labor included. Installation and calibration are not covered by this warranty agreement. The Technical Services Department must be contacted for warranty determination and direction prior to performance of any repairs. Expendable items, glass, filters and gaskets are excluded from this warranty.

Replacement or repair of components parts or equipment under this warranty shall not extend the warranty to either the equipment or to the component part beyond the original warranty period. The Technical Services Department must give prior approval for return of any components or equipment. At Thermo's option, all non-conforming parts must be returned to Thermo Fisher Scientific postage paid and replacement parts are shipped FOB destination.

THIS WARRANTY IS EXCLUSIVE AND IN LIEU OF ALL OTHER WARRANTIES, WHETHER WRITTEN, ORAL OR IMPLIED. NO WARRANTIES OF MERCHANTABILITY OR FITNESS FOR A PARTICULAR PURPOSE SHALL APPLY. Thermo shall not be liable for any indirect or consequential damages including, without limitation, damages relating to lost profits or loss of products.

Your local Thermo Sales Office is ready to help with comprehensive site preparation information before your equipment arrives. Printed instruction manuals carefully detail equipment installation, operation and preventive maintenance.

If equipment service is required, please call your Technical Services Department at 1-800-438-4851 (USA and Canada) or 1-740-373-4763. We're ready to answer your questions on equipment warranty, operation, maintenance, service and special application. Outside the USA, contact your local distributor for warranty information.



Rev. 0 9/13

For the name of the authorized Thermo Scientific product dealer nearest you or any additional information, contact us:

North America: USA/Canada +1 866 984 3766 (866-9-Thermo) www.thermo.com

Europe: Austria +43 1 801 40 0, Belgium +32 2 482 30 30, France +33 2 2803 2180, Germany national toll free 08001-536 376, Germany international +49 6184 90 6940, Italy +39 02 02 95059 434-254-375, Netherlands +31 76 571 4440, Nordic/Baltic countries +358 9 329 100, Russia/CIS +7 (812) 703 42 15, Spain/Portugal +34 93 223 09 18, Switzerland +41 44 454 12 12, UK/Ireland +44 870 609 9203

Asia: China +86 21 6865 4588 or +86 10 8419 3588, India toll free 1800 22 8374, India +91 22 6716 2200, Japan +81 45 453 9220, other Asian countries +852 2885 4613

Countries not listed: +49 6184 90 6940 or +33 2 2803 2180

Thermo Fisher Scientific
401 Millcreek Road
Marietta, Ohio 45750
United States

www.thermofisher.com

ThermoFisher
S C I E N T I F I C