

Motic[®]

AE31E Series

Inverted Microscope

Instruction Manual



Note

If the equipment is used in a manner not specified by the manufacturer, the protection provided by the equipment may be impaired.

WWW.MOTIC.COM

MOTIC INCORPORATION LTD.

CE

We are constantly endeavouring to improve our instruments and to adapt them to the requirements of modern research techniques and testing methods. This involves modification to the mechanical structure and optical design of our instruments.

Therefore, all descriptions and illustrations in this instruction manual, including all specifications are subject to change without notice.

Content

1. Nomenclature	4
1.1 Application	4
1.2 Nomenclature	5
1.3 Technical data	7
2. Setting-up the Instrument	8
2.1 Working Environment	8
2.2 Input voltage and power	8
2.3 Illumination	9
2.3.1 Halogen bulb	9
2.3.2 LED module	9
3. Assembling the Microscope	10
3.1 Installing the bulb/ LED module	10
3.1.1 30W Halogen	10
3.1.2 100W Halogen	11
3.1.3 LED module	12
3.2 Filter Holder	14
3.3 Mounting the Condenser	14
3.4 Installing the Objectives	15
3.5 Mechanical Stage	16
3.6 Inserting the Eyepieces	16
4. Microscope Handling	17
4.1 Interpupillary Distance Adjustment	17
4.2 Diopter Adjustment	17
4.3 Coarse and fine focusing	18
4.4 Coarse focus torque adjustment	18
4.5 Brightfield Microscopy	19
4.6 Phase Contrast Microscopy	19
4.7 Filter selection	22
4.8 Brightness control	22
4.9. IR function	23
4.10 Auto light intensity reproduction	23

5. Photomicrographic Procedure (Only on AE31E TRI)	24
6. Troubleshooting Table	25
6.1 Optical and Operating Problems	25
6.2 Electrical	25
7. Care and Maintenance	26
7.1 Lenses and Filters	26
7.2 Cleaning of Painted or Plastic Components	26
7.3 When Not in Use	26
7.4 Warning Label	27

1. Nomenclature

1.1 Application

The new Inverted microscope AE31E is representing the ideal instrument for living cells observation and other microbiological samples. Due to our Colour Corrected Infinity Optics (CCIS) the AE31E offers superior image quality combined with excellent mechanical performance. Daily work is facilitated by a number of ergonomic features.

1.2 Nomenclature

Model AE31E TRI

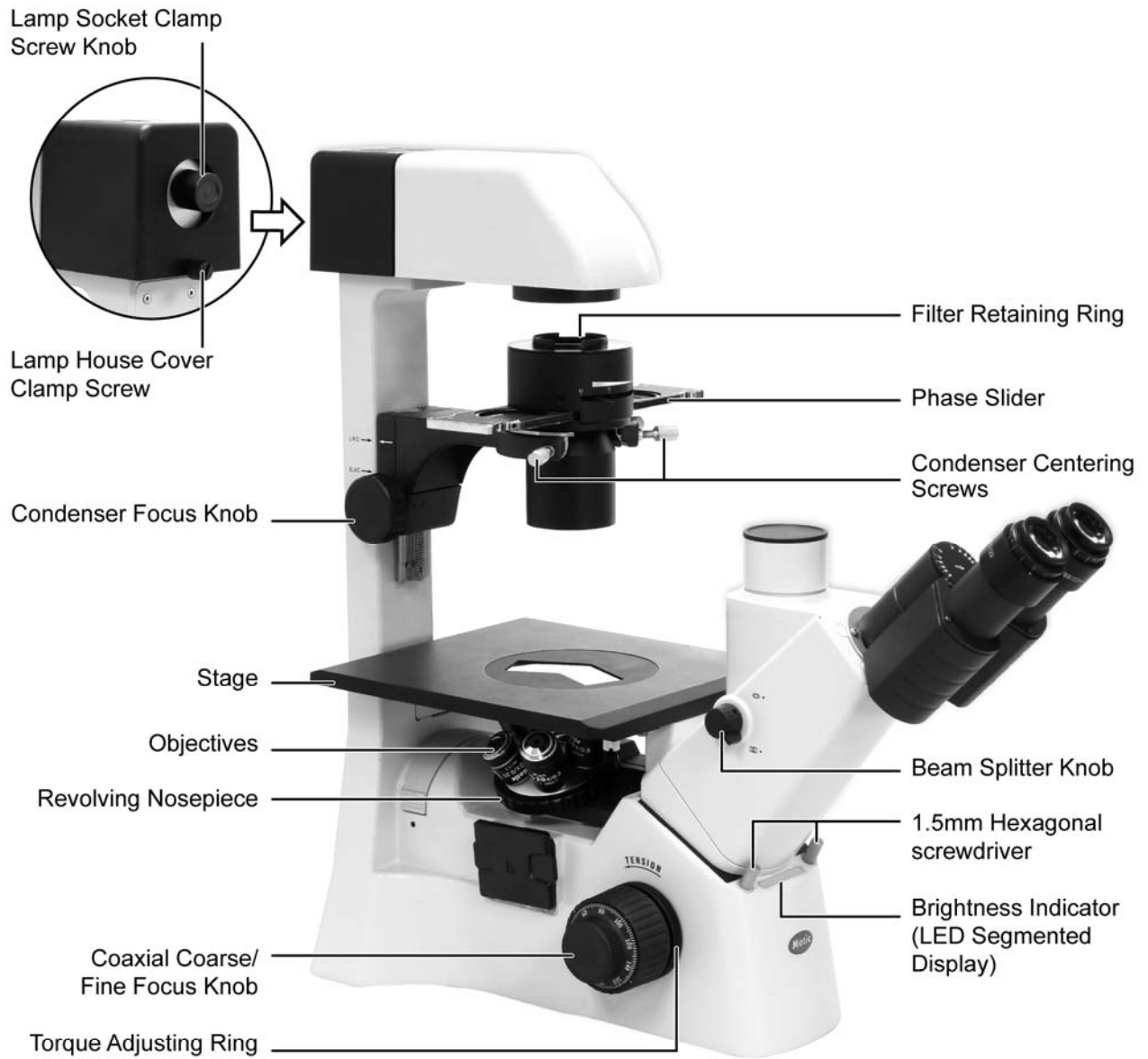

(Fig.1)

Model AE31E TRI

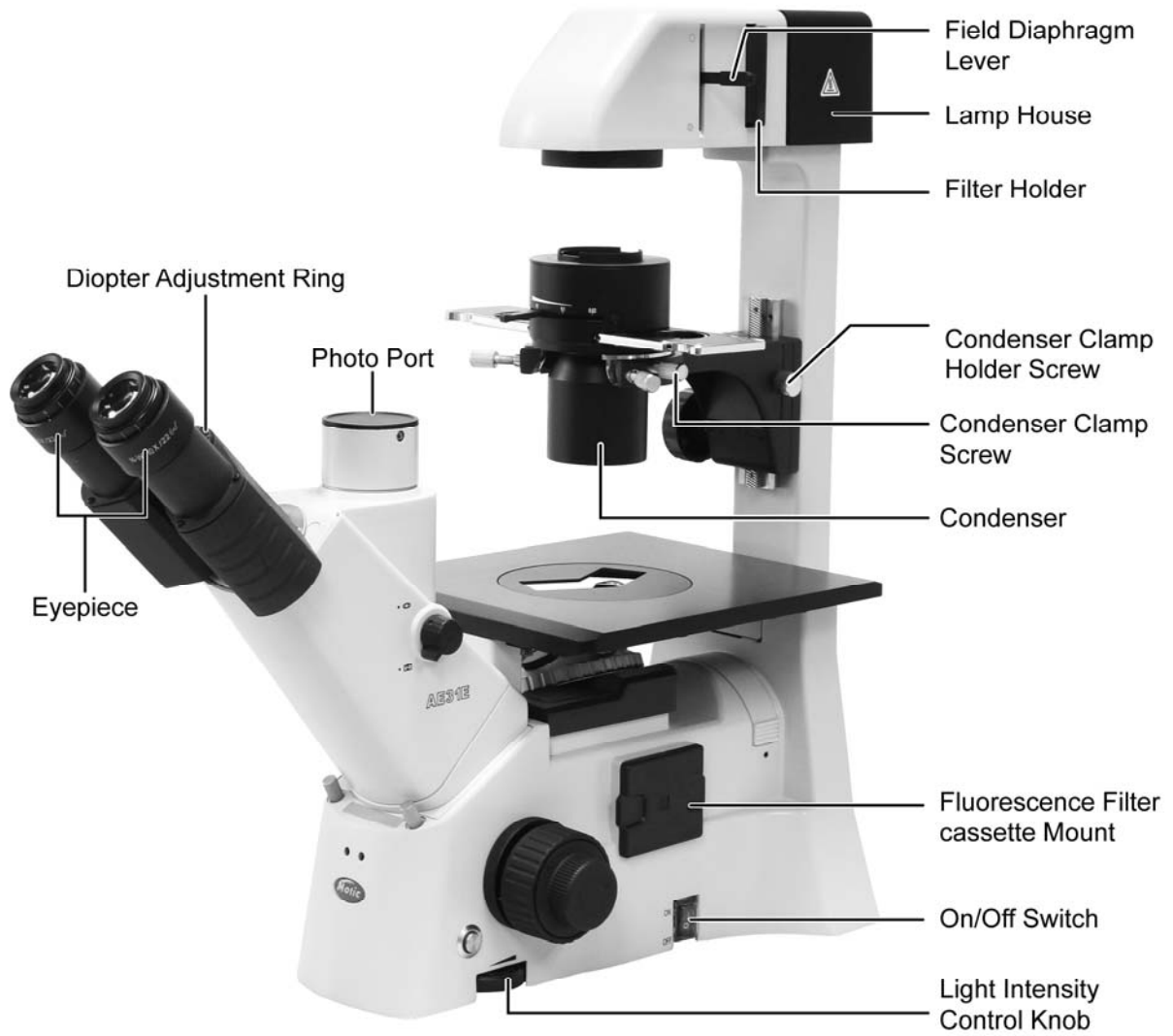

(Fig.2)

1.3 Technical data

Technical data	AE31E BIN	AE31E TRI
Optical system	Color Corrected Infinity Optics (CCIS)	
Total Magnification	40X - 400X	
Eyepiece tubes	360° Swiveling Siedentopf with upper and lower position: upper position offers approx. 40 mm extra viewing height	
	Interpupillary distance: 48 mm to 75 mm	
	Binocular 45° Inclined	Trinocular 45° Inclined
Eyepiece	N-WF 10X(Ø22), wide field, high eye point	
Nosepiece	Quintuple, inclined, sideways	
Stage	Fixed, Dimensions (width x depth): 200 x 239mm	
	Stage height 192mm	
Object guide	Verniers with numerical and alphabetic scale	
	X direction: numerical scale, readable from right to left	
	Y direction: alphabetic scale	
Objectives	Plan-Achromat 4x, N.A.0.1, W.D.12.6mm	
	Plan-Achromat 10x, N.A.0.25, W.D.16.8mm	
	LWD Plan-Achromat 20x, N.A.0.3, W.D.4.7mm	
	LWD Plan-Achromat 40x, N.A.0.5, W.D.3mm	
	Plan-Achromat PH 4x Ph0, N.A.0.1, W.D.12.6mm	
	Plan-Achromat PH 10x Ph1, N.A.0.25, W.D.4.1mm	
	LWD Plan-Achromat PH 20x Ph1, N.A.0.3, W.D.4.7mm	
	LWD Plan-Achromat PH 40x Ph1, N.A.0.5, W.D.3mm	
	LWD Plan-Achromat PH 40x Ph2, N.A.0.5, W.D.3mm	
Condenser	N.A.0.3, W.D.72mm	
	N.A.0.5, W.D.28mm	
Coarse focus	42mm/rot.	
Fine focus	0.2mm/rot.	
Transmitted illumination	6V/30W Halogen	
	12V/100W Halogen	
	3W LED module	
Dimension: W x D x H	217.5 x 556 x 497mm	

v2. Setting-up the Instrument

2.1 Working Environment

The location should be free from dust, moisture, chemical vapours and free of mechanical vibrations.

Don't locate the instrument in bright or direct ambient light, in front of a lamp, or a bright light wall.

Best imagequality will be achieved in a surrounding surrounding with low ambient light.

Environmental specification:

- Indoor use
- Altitude: Max 2000m
- Ambient temperature: 15°C~ 40°C;
- Maximum relative humidity: 75% for temperature up to 31°C decreasing linearly to 50% relative humidity at 40°C
- Supply voltage fluctuations: Not to exceed $\pm 10\%$ of the normal voltage
- Pollution degree: 2 (in according with IEC60664)
- Installation/Overtoltage category: 2 (in according with IEC60664)
- Air Pressure of 75kPa to 106 kPa

2.2 Input voltage and power

Automatic voltage selection works with electrical outlets worldwide. It is advised to always use a power cord that is rated for the voltage used in your area and that has been approved to meet local safety standards. Using the wrong power cord could cause fire or equipment damage.



In order to prevent electric fluctuation to the instrument electrics, always turn the power switch on the instrument off before connecting the power cord.

Electrical Specifications:

30W Halogen bulb

Input: 100-240V~, 45W, 50-60Hz

Lamp: DC6V  30W Halogen

Fuse: 250V T2.5A

(If the original fuse is damaged, please replace a new one with same specification)

100W Halogen bulb

Input: 100-240V~, 120W, 50-60Hz

Bulb: 12VDC 100W Halogen

Fuse: 250V T2.5A (If the original fuse is blown, please replace with specified fuse)

LED module

Input: 100-240V~, 80VA, 50-60Hz

LED: 3.4V $\overline{\text{---}}$ 3W

Fuse: 250V T2.5A (If the original fuse is blown, please replace with specified fuse)

- LED module high color temperature: $6000 \pm 300\text{k}$
- LED module low color temperature: $4500 \pm 300\text{k}$

Attention: The plug of the power adaptor is the "disconnect device" for whole unit. To save energy we recommend to unplug the instrument when not in use.

This device complies with Part 15 of the FCC Rules.

Operation is subject to the following two conditions:

- (1) This device may not cause harmful interference, and (2) this device must accept any interference received, including interference that may cause undesired operation.

2.3 Illumination

2.3.1 Halogen bulb

The quartz halogen bulb, used as a light source, has higher luminance and colour temperature than conventional tungsten lamps. The luminance of halogen bulb is approximately four times brighter than the conventional tungsten lamps.

As long as the lamp voltage is kept constant, the halogen lamp maintains the same level of brightness and colour temperature regardless of whether it is new or nearing the end of its life span.

2.3.2 LED module

The LED module is specially designed to be inserted into halogen bulb socket directly converting halogen illumination to LED illumination. LED is more economical and environmental friendly and combines the advantages of low heat and long life span.

3. Assembling the Microscope

3.1 Installing the bulb/ LED module

3.1.1 30W Halogen

- In order to prevent electric shock always turn the on/off switch off (Fig.3) and unplug the power cord before replacing the lamp.



(Fig.3)

- Release lamp housing cover clamp screw (Fig.4-1) to remove the cover (Fig.4-2).



(Fig.4-1)



(Fig.4-2)

- Firmly insert the bulb into the socket pinholes until it reaches the limit (Fig.4-3), be careful not to tilt the lamp when mounting. (Fig.4-4)
- When installing the lamp, do not touch the glass surface of the lamp with bare fingers. Doing so will cause fingerprints, grease, etc., to burn onto the lamp surface, reducing the illumination provided by the lamp. If surface is contaminated, wipe it clean using lens tissue.

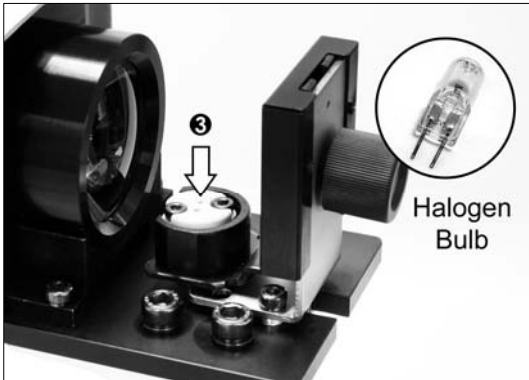

(Fig.4-3)



(Fig.4-4)

3.1.2 100W Halogen

- The applicable halogen bulbs are the 12V 100W HAL high-intensity bulb. (Osram, model: 64625 HLX)
- In order to prevent electric shock always turn the power switch off and unplug the power cord before installing or replacing the lamp.
- Loosen the lamp housing cover clamp screw (Fig.5-1) and remove the cover (Fig.5-2).
- When installing the bulb, do not touch the glass surface of the bulb with bare fingers. (Fig.24) Doing so will cause fingerprints, grease, etc., to burn onto the bulb surface, reducing the illumination provided by the bulb. If the surface is contaminated, wipe it clean using lens tissue.
- Firmly insert the bulb into the socket pinholes until it reaches the limit. Be careful not to tilt the bulb when mounting. (Fig.5-3)
- Close the cover and secure with it with lamp housing cover clamp screw. (Fig.5-4)



(Fig.5-1)

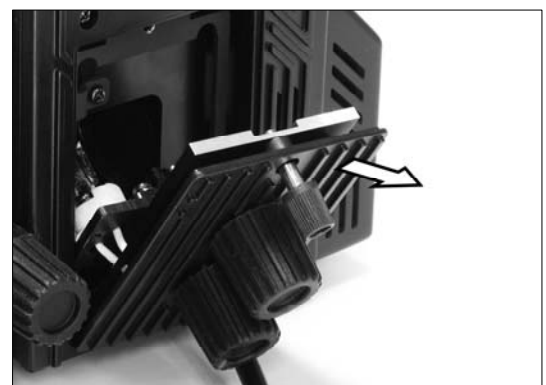

(Fig.5-2)

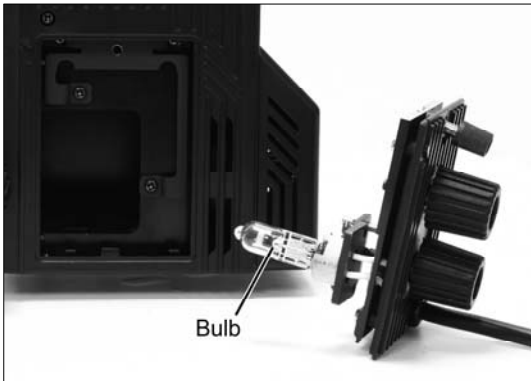

(Fig.5-3)

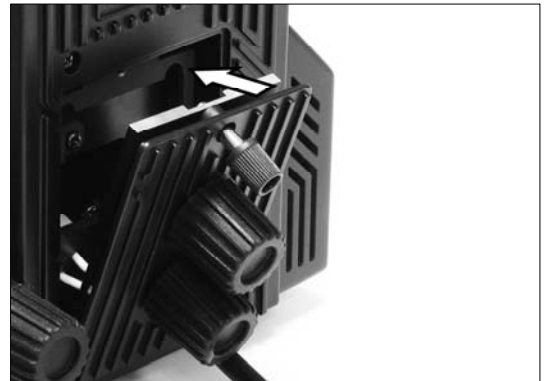

(Fig.5-4)

3.1.3 LED module

- In order to prevent electric shock always turn the on/off switch off and unplug the power cord before replacing the lamp. (Fig.6-1)



(Fig.6-1)

- Release lamp housing cover clamp screw (Fig.6-2) using a coin to remove the cover. (Fig.6-3)



(Fig.6-2)



(Fig.6-3)

- Firmly insert the LED module into the socket pinholes (Fig.6-4) until it reaches the limit (Fig.6-5). This is a Motic **patented** design to exchange LED module and halogen bulb on the same socket directly. (3W LED module is used for 30W lamp house only)
- After the LED module installation, secure it with the clamp screw by 1.5mm hexagonal screwdriver supplied with the microscope. (Fig.6-6)

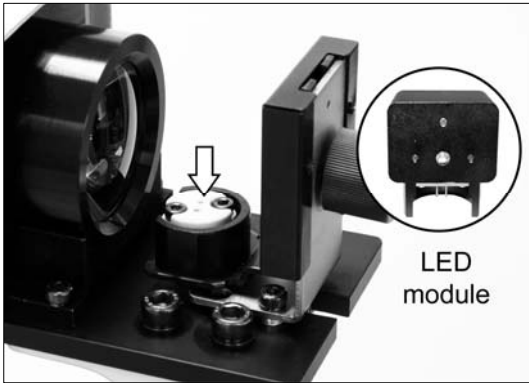

(Fig.6-4)

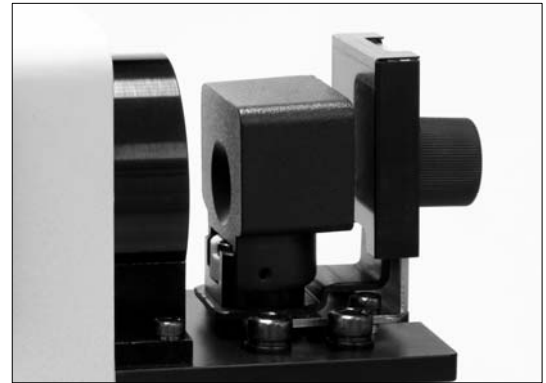

(Fig.6-5)

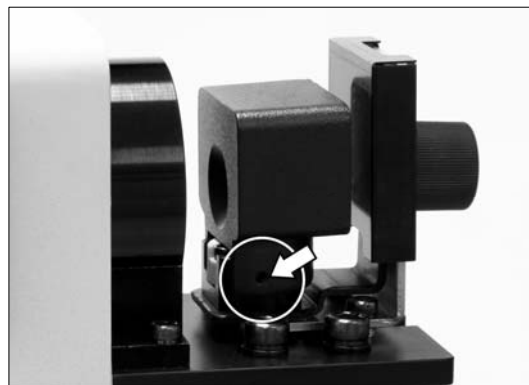

(Fig.6-6)

- Close the cover and fasten with it with lamp housing cover clamp screw.
- Insert the filter slider with mat surface of the diffuser turned towards the user.

3.2 Filter Holder

- Filter holder is located in front of the lamp house (Fig.7-1) for easy replacement of the filter. (Fig.7-2)



(Fig.7-1)



(Fig.7-2)

3.3 Mounting the Condenser

- Mount the condenser on the dovetail mount of the condenser holder (Fig.5-1) with the aperture diaphragm lever facing the front. Secure it with the clamp screw by the 2.5mm hexagonal screwdriver (supplied with the microscope, Fig.8-2)



(Fig.8-1)



(Fig.8-2)

- If Phase contrast is to be used, insert the Phase slider into the slot of the condenser. The centering screws of Phase slider have to face the front side. (Fig.8-3)

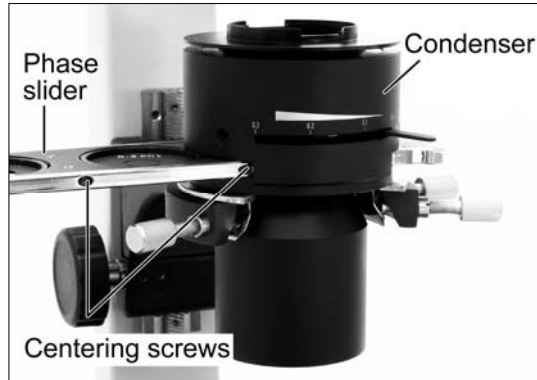

(Fig.8-3)

3.4 Installing the Objectives

- Remove the stage insert from the stage. (Fig.9-1)
- Screw in the objectives in the nosepiece thread holes in a manner that the magnification increases with clockwise rotation of the revolving nosepiece. (Fig.9-2)
- Place back the stage insert.

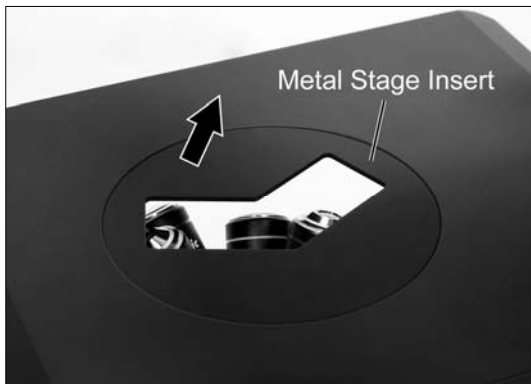

(Fig.9-1)



(Fig.9-2)

3.5 Mechanical Stage (Fig.10)

- An attachable mechanical stage is available as an option. This stage allows the precise x/y movement of common vessels for cell culture. For choosing the respective vessel carrier, please contact your local Motic supplier.
- Secure the mechanical stage to the AE31E plain stage using the two mounting screws located beneath the stage on the right side (user facing the front of the instrument).



(Fig.10)

3.6 Inserting the Eyepieces

- Remove the dust caps from the eyepiece tubes.
- Use the same magnification eyepieces for both the eyes.
- Insert each eyepiece into the eyepiece sleeve by a twisting movement. (Fig.11)
- Should the rubber eye guards are to be used, fit them in the groove around the eyepiece.



(Fig.11)

4. Microscope Handling

4.1 Interpupillary Distance Adjustment (Fig.12-1)

- Before adjusting the interpupillary distance, bring a specimen into focus using the 10x objective.
- Adjust the interpupillary distance so that both the right and left field of view become one. This adjustment will enable the user to observe the specimen with both eyes.

4.2 Diopter Adjustment (Fig.12-2)

- Diopter adjustment compensates for the differences in vision between the left and right eyes. In addition to making observation through both eyes easier, this adjustment also reduces the extent to which focusing is lost when the objective magnification is changed. In particular, this occurs when a low magnification objective is used.
- Set the diopter on both eyepieces to the “0” position.
- Swing in the 10x objective, focus with one eye only (as everybody has got a “strong” eye, use this one for this first focussing).



(Fig.12-1)



(Fig.12-2)

- When in focus, close this eye and use the other one. Focus by only using the diopter ring on the respective eyepiece, do not use the coarse/fine knob!
- Change to a higher magnification and repeat the complete procedure.
- As the focus depth is less in high magnification lenses, a precise adjustment of the diopters here is easier. Keep this final diopter position for all lenses.

4.3 Coarse and fine focusing (Fig.13-1)

- For focusing of the instrument please use the coarse and fine focus knobs on the left and right side of the microscope stand.
- The direction of vertical movement of the revolving nosepiece corresponds to the turning direction of the focus knobs.
- One full rotation of the fine focus knob moves the nosepiece 0.2mm in z-direction. One scale unit on the fine focus knob equals 2 microns.

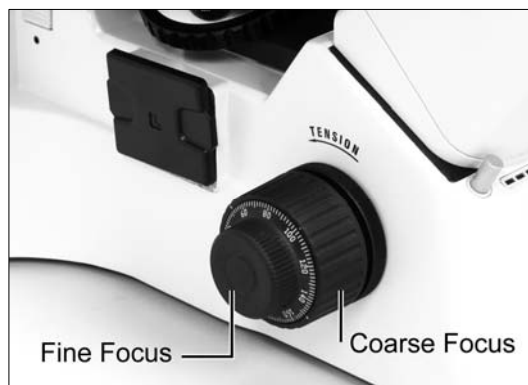

(Fig.13-1)

Please avoid following action:

Never attempt either of the following actions, since doing so will damage the focusing* mechanism.

- Rotate the left or right knob while holding the other.
- Turning the coarse and fine focus knobs further than their limit.

4.4 Coarse focus torque adjustment (Fig.13-2)

- To increase the torque, turn the torque adjustment ring located behind the left-hand coarse focus in the direction of the arrow. To reduce the torque, turn the ring in the direction opposite.



(Fig.13-2)

4.5 Brightfield Microscopy

- Set the Phase slider to the centre position (in standard configuration this position does not contain an illumination annulus) (Fig.14). In case all 3 positions of the slider are occupied due to personal setup of the microscope, pull out the complete slider.
- Bring the specimen into focus.
- The aperture diaphragm of the condenser is needed for adjusting the numerical aperture (N.A.) of the illumination.
- Closing the aperture diaphragm will lower the resolution and brightness but increase the contrast and depth of focus. An image with appropriate contrast in most cases can be obtained with an aperture diaphragm closed down to 2/3.



(Fig.14)

4.6 Phase Contrast Microscopy

- Phase contrast objectives are labelled "Ph": Ph0; Ph1; Ph2.
- For using phase contrast, be sure to use the annular ring in the slider has the same phase label as the objective:
Ph0: Objective 4x
Ph1: Objective 10x/20x/40x
Ph2: Objectives 20x/40x
- Always open the aperture diaphragm completely. If the aperture diaphragm is closed, it will obstruct the annular diaphragm and the phase contrast effect cannot be obtained.
- Bring the 10x (Ph1) objective into optical path.
- Position the Phase annular diaphragm slider to Ph1.

- Remove one eyepiece from the eyepiece tube and insert the phase centering telescope instead. (Fig.15)
- Loosen the fixing screw on the centering telescope. By pulling out the inner part of the centering telescope, you may focus on a dark ring inside the phase contrast objective (this circular phase plate is responsible for the phase effect). Simultaneously, you will realize the image of the illumination annulus which is projected into the same “back focal plane” by the condenser.



(Fig.15)

- If the objective phase plate and the illumination annulus do not coincide, use the two allen keys (1.5mm) supplied with the microscope (Fig.16-1). Insert the keys into the countersunk screws. Turn the keys to move the illumination annulus in the slider until the image of the illumination annulus is concentric with the phase plate (Fig.16-2).
- This complete procedure has to be performed for the respective phase lens/illumination ring combinations.
- If the image of the illumination ring is diverging from the phase plate in the objective, a low phase contrast image will result.
- For construction reasons the phase rings in the different objectives are located in different levels (“back focal planes”). So for each objective you will have to focus again with the centering telescope.



(Fig.16-1)

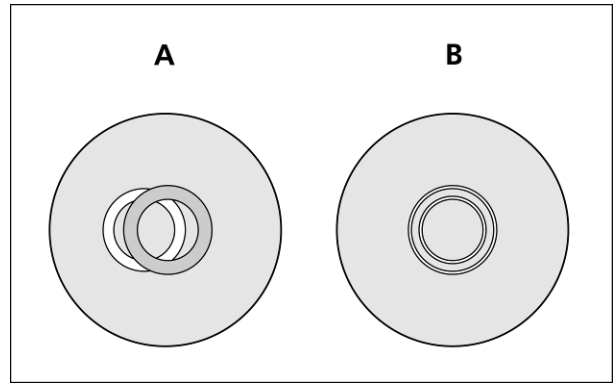

(Fig.16-2)

- To achieve maximum contrast in phase contrast a Green Interference filter is recommended. It may be inserted in the filter mount of the condenser carrier.
- To insert/replace an annular diaphragm take care the diaphragm has got the correct orientation (Fig.16-3). Push the diaphragm against the flexible filament until it fits in the hole (Fig.16-4). If necessary, use the allen keys to bring the annulus to the center of the hole. A fine adjustment will be done by using the centering telescope (see above).



(Fig.16-3)

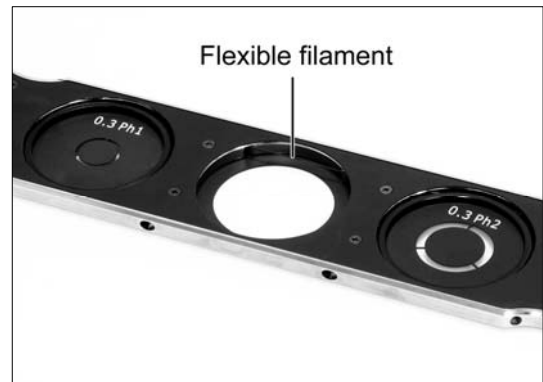

(Fig.16-4)

4.7 Filter selection

Filter holder can hold two filters

Filter type	Procedure
ND (Neutral Density) filter	For intensity adjustment in photomicrography
GIF (Green Interference) filter 546nm	For phase contrast and contrast adjustment with black and white film
Blue filter	For general microscopy and colour photomicrography

4.8 Brightness control

- Turn on the microscope by on/off switch (Fig.17-1), then adjust the brightness with light intensity control knob (Fig.17-2).
- The selected intensity is shown on the brightness indicator (Fig.17-3).
- When switch to maximum level, the red light will light up. (Fig.17-3)



(Fig.17-1)



(Fig.17-2)



(Fig.17-3)

4.9. IR function

- Push the button (Fig.18-1), the blue pilot lamp indicates that an IR-sensor is activated (Fig.18-2). If no user is detected in front of the microscope, the microscope illumination will automatically switch off after 15 minutes. When the user returns, the illumination will start again.



(Fig.18-1)



(Fig.18-2)

4.10 Auto light intensity reproduction

- Rotate the desired Objective into the light path by turning the nosepiece on its knurled collar and adjust Intensity according to the actual slide sample. After 10 seconds of constant illumination, the system will store this brightness value as setting and it will repeat this illumination setting once the same Nosepiece position with Objective will be rotated into the light beam again.
- Manual changes to this setting are possible every moment of time, once the new illumination brightness will be constant for 10s again, it will override the last setting
- Repeat procedure according to above procedure for all installed nosepiece positions

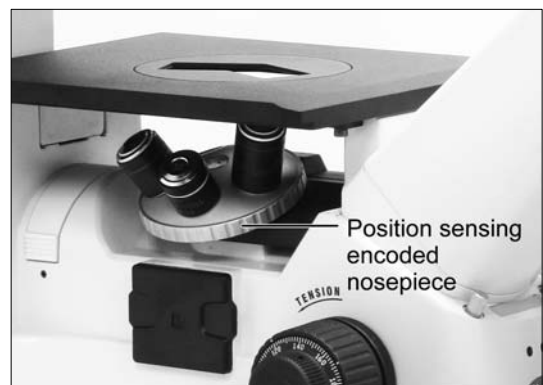

(Fig.19)

5. Photomicrographic Procedure (Only on AE31E TRI)

- To ensure vibration free operation, set the microscope on a sturdy vibration free table or a bench with a vibration proof device.
- Turn the beam splitter knob of the eyepiece tube to the “photo position” (Fig.20). The photo exit is activated, 80% of the light will enter the camera.
- Select a blue filter for routine application. An additional colour-compensating filter can also be used depending on the colour rendition.
- A change of depth of focus, contrast and resolution of image is attainable with an aperture setting of about 2/3 maximum. Fine setting of the condenser aperture is depending on the individual sample.
- For photomicrographic procedures, refer to the manual of the specific camera being used.

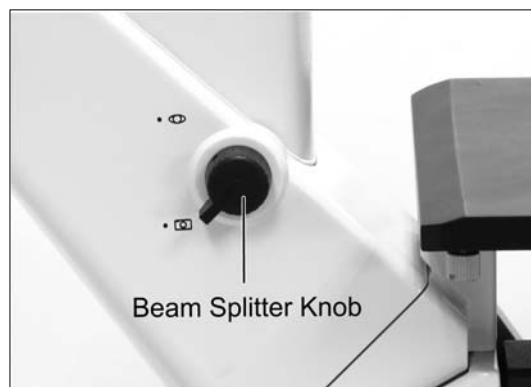

(Fig.20)

6. Troubleshooting Table

As you use your microscope, you may occasionally experience a problem. The troubleshooting table below contains the most frequently encountered problems and their possible causes.

6.1 Optical and Operating Problems

Problem	Possible Cause
Vignetting or uneven brightness in the field of view or field of view only partially visible	Bulb not installed properly
	Filter slider in intermediate position
	Phase slider not in click-stop position
	Incorrect condenser mounting
	Aperture diaphragm closed too far
	Revolving nosepiece not clicked into position
	Beam splitter knob not clicked into position (Mod. AE31E trinocular only)
Dust or dirt in field of view	Aperture diaphragm closed too far
	Dust or dirt on specimen's surface
Inadequate image quality	Brightfield objective used with Phase illumination
	Annular ring does not fit to objective phase ring
	Annular ring has to be readjusted
Eye strain or fatigue	Interpupillary distance not adjusted
	Diopter adjustment not made
	Inadequate illumination

6.2 Electrical

Problem	Possible Cause
Lamp does not light	Power supply not plugged in
	Light Bulb not installed
	Light Bulb burnt out
Inadequate brightness	Specified lamp not being used
Lamp blows out immediately	Specified lamp not being used
Lamp flickers	Connectors are not securely connected
	Near end of life time
	Light Bulb not securely plugged into socket

7. Care and Maintenance

7.1 Lenses and Filters

- To clean lens surfaces or filters, first remove dust using an air blower. If dust still persists, use a soft / clean brush or gauze.
- A soft gauze or lens tissue lightly moistened with Isopropyl alcohol to remove grease or fingerprints.
- To remove immersion oil residues from objective lenses, use a soft gauze or lens tissue lightly moistened with Isopropyl alcohol.
*** Warning: Isopropyl alcohol is highly flammable, be careful with handling and never use in the presence of open flames or hot surfaces. ***
- Do not use same area of gauze or lens tissue to wipe more than once.

7.2 Cleaning of Painted or Plastic Components

- Do not use organic solvents (thinners, alcohol, ether, etc.). Doing so could result in discolouration or in the peeling of paint.
- For stubborn dirt, moisten a piece of gauze with diluted detergent and wipe clean.
- For plastic components, only moisten a piece of gauze with water and wipe clean.

7.3 When Not in Use



- When not in use, cover the instrument with vinyl dust cover and store in a place low in humidity where mould is not likely to form.
- Store the objectives, eyepieces and filters in a container or desiccator with drying agent.

Note:

If equipment is used in a manner not specified by the manufacturer, the protection provided by the guarantee terms may be effected.

7.4 Warning Label

The following warning symbols are found on the microscope. Study the meaning of the warning symbols and always use the equipment in the safest possible manner.

Warning Label / Symbol	Explanation
	Indicates that the surface becomes hot, and should not be touched with bare hands.
	CAUTION! Risk of danger. (See user manual)

Proper handling of the microscope will ensure years of trouble free service.

If repair become necessary, please contact your Motic Dealer or our Technical Service directly.

Motic®

CE NO.: 1300901109221

Motic Incorporation Ltd. (Hong Kong)

Rm 2907-8, Windsor House, 311 Gloucester Road, Causeway Bay, Hong Kong Tel: 852-2837 0888 Fax: 852-2882 2792

Motic Instruments Inc. (Canada)

130-4611 Viking Way, Richmond, B.C., V6V 2K9 Canada Tel: 1-877-977 4717 Fax: 1-604-303 9043

Motic Deutschland GmbH (Germany)

Christian-Kremp-Strasse 11 D-35578 Wetzlar, Germany Tel: 49-6441-210 010 Fax: 49-6441-210 0122

Motic Spain, S.L. (Spain)

Polígon Industrial Les Corts, Camí del Mig, 112 08349 Cabrera de Mar, Barcelona Spain Tel: 34-93-756 6286
Fax: 34-93-756 6287

Website: <http://www.motic.com>

E-mail: info@moticon.com.hk

Motic China Group., Ltd. (China)

Motic Building, Torch Hi-Tech Industrial, Development Zone, Xiamen P.R.C. Tel: 86-0592-562 7866 Fax: 86-0592-562 7855

© 2007-2013 Motic China Group Co., Ltd. All rights reserved. Motic is a registered trademark and service mark of Motic China Group Co., Ltd. Microsoft Windows logo is a registered trademark of Microsoft Corporation. All other trademarks are the property of their respective owners.

Design Change: The manufacturer reserves the right to make changes in instrument design in accordance with scientific and mechanical progress, without notice and without obligation.