

**Motic**<sup>®</sup>

MORE THAN MICROSCOPY



LS

**AE2000**

ROUTINE LIVE CELL MICROSCOPE SOLUTION

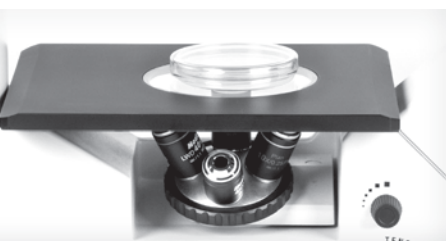

## CONTENTS AE2000 CATALOGUE

<b>INTRODUCTION</b>	<b>02</b>
THE MECHANICS	04
THE OPTICS	06
THE ILLUMINATION	08
CONTRAST METHODS	10
DOCUMENTATION	12
SPECIFICATIONS	14

The AE2000 microscopes are Motic's entry models of inverted microscopes, providing a flexible optical concept to meet best image quality and robust design for a long lifetime under rough lab conditions. The AE2000 is the perfect microscope for routine microbiology in clinical and pharmaceutical laboratories, also offering best options for university teaching.

In full accordance with Motic's CCIS® Infinity System, the LWD Plan Achromatic objectives with an ingenious Phase contrast concept deliver a remarkable image quality. 10X and 20X Phase Contrast objectives are an integral part of all standard packages, while the optional 4X Phase objective is dedicated to fast screening. A 40X Phase objective is available too.

The AE2000 stand carries a quadruple nosepiece with a precise click stop of objective positions. Rich illumination power is given by the 30 Watt Halogen light source in a Fixed-Koehler setup, simply interchangeable with 3W LED modules of different color temperatures.

The Auto ON/OFF function, based on a built-in IR-sensor, deactivates the microscope in case it is left by the user: no need for a final instrument check when work is finished.

The complete AE2000 microscope is manufactured in compliance with European RoHS standards to avoid contact with lead-containing materials. An anti-fungus treatment is applied to all parts of the microscope to protect the system in humid environments.

*Your Motic Europe Team*

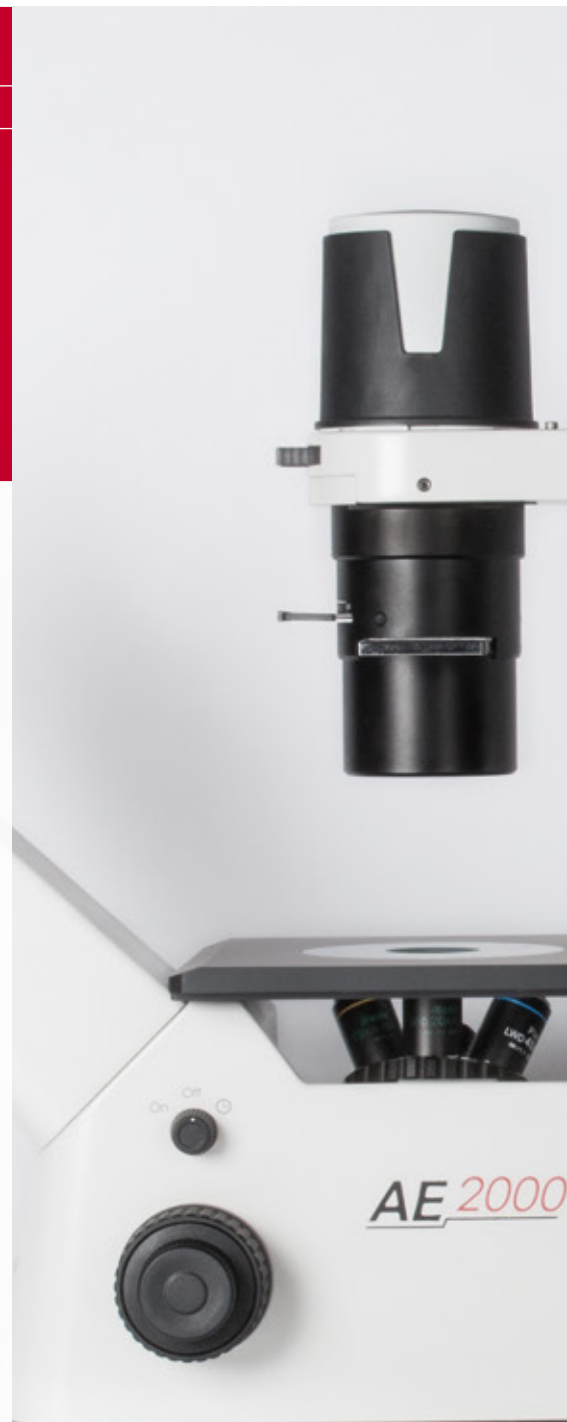

# AE2000

ROUTINE LIVE CELL MICROSCOPE SOLUTION



# THE MECHANICS

STAND & STAGE | EYEPIECE TUBES



INTRODUCTION

**THE MECHANICS**

THE OPTICS

THE ILLUMINATION

CONTRAST METHODS

DOCUMENTATION

SPECIFICATIONS



## IMPROVED ERGONOMY FOR EFFICIENT WORK

Motic's AE2000 models display smart functionality and ergonomics in all mechanical aspects. Elegant and robust, the microscope stand follows all needs for an intense daily use. The fixed stage plate with optional lateral extensions carries a glass or metal insert for quick overview and comfortable change of objectives. An optional x/y object guide for convenient sample examination under high magnifications is available.

Focusing is done by a 4-fold nosepiece. With a fine focus step size of 2 microns a smooth drive through cell cultures and water samples, using the Long-Working-Distance objectives, is easily performed.

The AE2000 eyepiece tubes allow an individual seating position as the "butterfly" mode may increase the viewing height by 60mm. A fatigue-free work is guaranteed by a viewing angle of 45° and an improved interpupillary distance of 48-75mm.



MECHANICAL STAGE



GLASS STAGE INSERT



# THE OPTICS

OBJECTIVES | EYEPIECES



- INTRODUCTION
- THE MECHANICS
- THE OPTICS**
- THE ILLUMINATION
- CONTRAST METHODS
- DOCUMENTATION
- SPECIFICATIONS



## SMART PHASE CONTRAST FOR DAILY ROUTINE WORK

Motic's new LWD Plan Achromatic objectives for inverted microscopes provide a clever concept for Phase contrast. One illumination ring (Ph1) covers the objective magnifications 10X, 20X and 40X. No need to move the Phase ring slider when changing the magnification. The optional 4X Phase lens requires Phase ring Ph0 and is dedicated to quick and efficient sample screening.

An optimized multi-layer coating for improved contrast as well as carefully selected glass quality for better transmission leads to significantly brighter images, especially in fluorescence. Motic is pleased to offer this newly developed optics following the RoHS regulations for lead-free manufacturing.

All optical components work together to deliver a perfect image: condenser, objectives, tube lens and eyepieces. Since the intermediate image is already fully corrected, no colored fringes will affect digital documentation results.



# THE ILLUMINATION

LIGHT SOURCES | LIGHT MEMORY FUNCTION

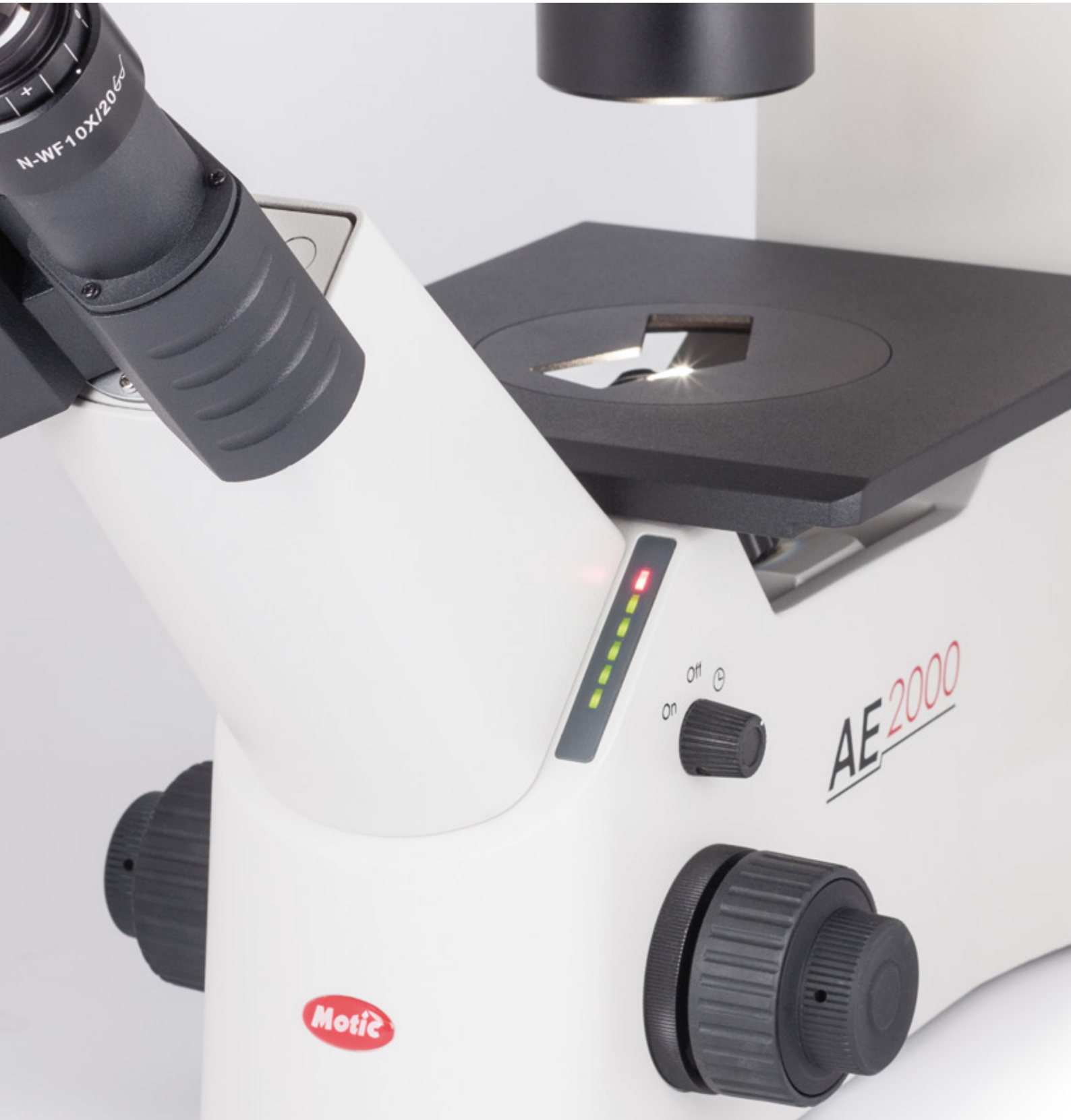



INTRODUCTION

THE MECHANICS

THE OPTICS

**THE ILLUMINATION**

CONTRAST METHODS

DOCUMENTATION

SPECIFICATIONS



## A POWERFUL AND FLEXIBLE ILLUMINATION CONCEPT

To take profit of Motic's improved optics, the illumination concept has to take care of power and quality. All stand versions of the AE2000 carry a Fixed-Koehler setup. The 30 Watt Halogen transmitted light source is standard and displays full interchangeability with 3 Watt LED modules of different color temperatures (4500K, 6000K). For higher illumination apertures, an LWD condenser with NA 0.5 can be implemented.

The built-in IR-sensor activates an Auto ON/OFF function in case the microscope is left and reactivates the microscope by return of the user. From an environmental perspective, this feature saves energy and increases lab safety.



HAL / LED INTERCHANGEABILITY

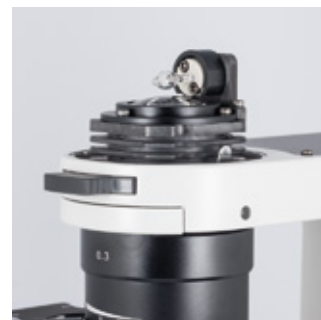

# CONTRAST METHODS

## PHASE CONTRAST



INTRODUCTION

THE MECHANICS

THE OPTICS

THE ILLUMINATION

**CONTRAST METHODS**

DOCUMENTATION

SPECIFICATIONS

0.02

Ph1

## PHASE CONTRAST FOR UNSTAINED SAMPLES

The standard configurations of the AE2000 already offer the full functionality of a microbiology workstation. Cell cultures in a petri dish or flask, but also other living (unstained) material like water samples from a pond require Phase Contrast to visualize internal structures from fungi, protozoans or algae, structures which are hardly visible by the Bright Field illumination, even if the condenser diaphragm is used perfectly.

In Phase contrast, differences in refractive index are translated into a black/white contrast image. Cell organelles, cell compartments and boundaries can be seen by an easy-to-handle technique. The switch from Bright Field (BF) to Phase Contrast is done by a simple push of the Phase ring slider from BF position to a Phase ring position. As one Phase ring (Ph1) corresponds to the objectives 10X/20X/40X, no need to change the slider position when changing the respective objectives.

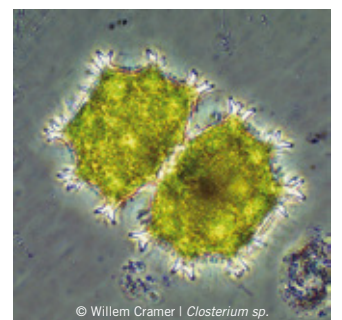

# DOCUMENTATION

STANDARD PHOTOMICROGRAPHY | DIGITAL DOCUMENTATION



INTRODUCTION  
 THE MECHANICS  
 THE OPTICS  
 THE ILLUMINATION  
 CONTRAST METHODS  
**DOCUMENTATION**  
 SPECIFICATIONS

## REPRODUCIBLE DOCUMENTATION RESULTS WITH HIGH RELIABILITY

Documentation is a key issue in every aspect of microscopy, with special importance in biomedical applications like microbiology. The AE2000 follows this requirement by traditional photomicrography or more flexible C-mount solutions.

Traditional photomicrography requires a Trinocular version of the AE2000. This setup delivers high resolution images of small fields. Live images for presentation and discussion may be supplied by the software of the SLR camera manufacturer.

A more convenient approach is provided by Motic's philosophy of easy digitization. The combination of the AE2000 with a member of Motic's camera series delivers excellent live images which can easily be shared with a larger public and saved for future analysis. All Moticams come equipped with a proprietary software package to transform the AE2000 into an analysis and documentation station.

For limited bench-top space, Moticam 1080 is ideal for the presentation of High Resolution images on an HDMI screen without a computer. The wireless models Moticam X and X<sup>3</sup> are dedicated to run under tablet and smartphone control through our "MotiConnect" App. Our tablet cameras with touch screen in first instance work as a fixed monitor solution, but may also create a hot-spot for remote tablet/smartphone access.

### MOTICAM TABLET SOLUTIONS

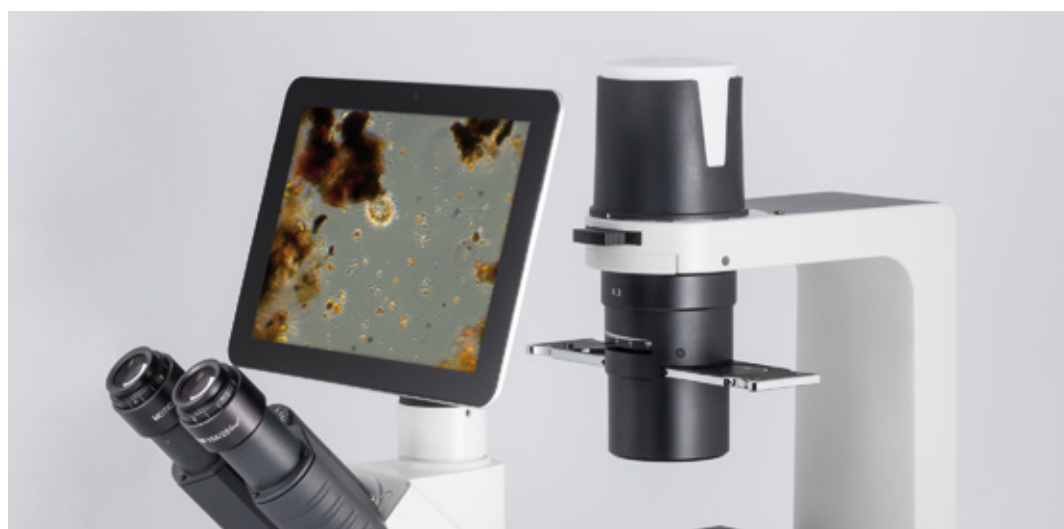

# SPECIFICATIONS

## AE2000

### STANDARD CONFIGURATION & OPTIONAL ACCESSORIES



General Specifications



Optional Configuration

Optical system	CCIS®	
Observation system	Swiveling 360° with 45° inclination	
Interpupillary distance (mm)	48-75	
Eyepieces	N-WF 10X/22	N-WF 12.5X/18; N-WF 15X/16
Eyepieces diopter adjustment	+/- 5 dpt	
Reticles (Ø25mm)		Crosshair 10mm/100 divisions Crossed double scale 10mm/100 divisions
Trinocular light split	20/80	
Nosepiece	Quadruple, side orientated	
Plan Achromat objectives	4X/0.10; Ph 10X/0.25; LWD Ph 20X/0.3; LWD 40X/0.5	Ph 4X/0.10; 10X/0.25; LWD 20X/0.3; LWD Ph 40X/0.5
Objective mounting thread RMS standard (W 4/5" X 1/36")	Yes	
Phase ring	Ph1 - universal phase ring from 10X up to 40X	Ph0 - for Ph 4X
Size stage plate (mm)	200 x 239	
Attachable x/y stage with inserts		Yes
Condenser	ELWD condenser N.A. 0.3 (WD 72mm)	Condenser NA 0.5 (WD 28mm); LWD condenser NA 0.4 (WD 53mm)
Focus mechanism	Coaxial; tension adjustment	
Fine focus precision (µm)	2	
Z-axis movement (mm)	8	
Illumination	30W Halogen/3W LED	
Halogen / LED interchangeability	Yes	
Illumination position	Built-in	
Koehler	No	
Auto ON/OFF	Yes	
Light memory	No	
Transformer	30W Halogen/3W LED Built-in	
Power supply	110-240V (CE)	
Filters	Blue, Green	Didymium, ND filters
Dimensions (mm)	556 x 218 x 496	
Weight (Kg)	12,2	
<b>Contrast techniques</b>		
Brightfield	Yes	
Phase contrast	Yes	
Relief contrast	No	

# SPECIFICATIONS

## AE2000

SCHEMATIC DIAGRAMS & SYSTEM DIAGRAM (units: mm)

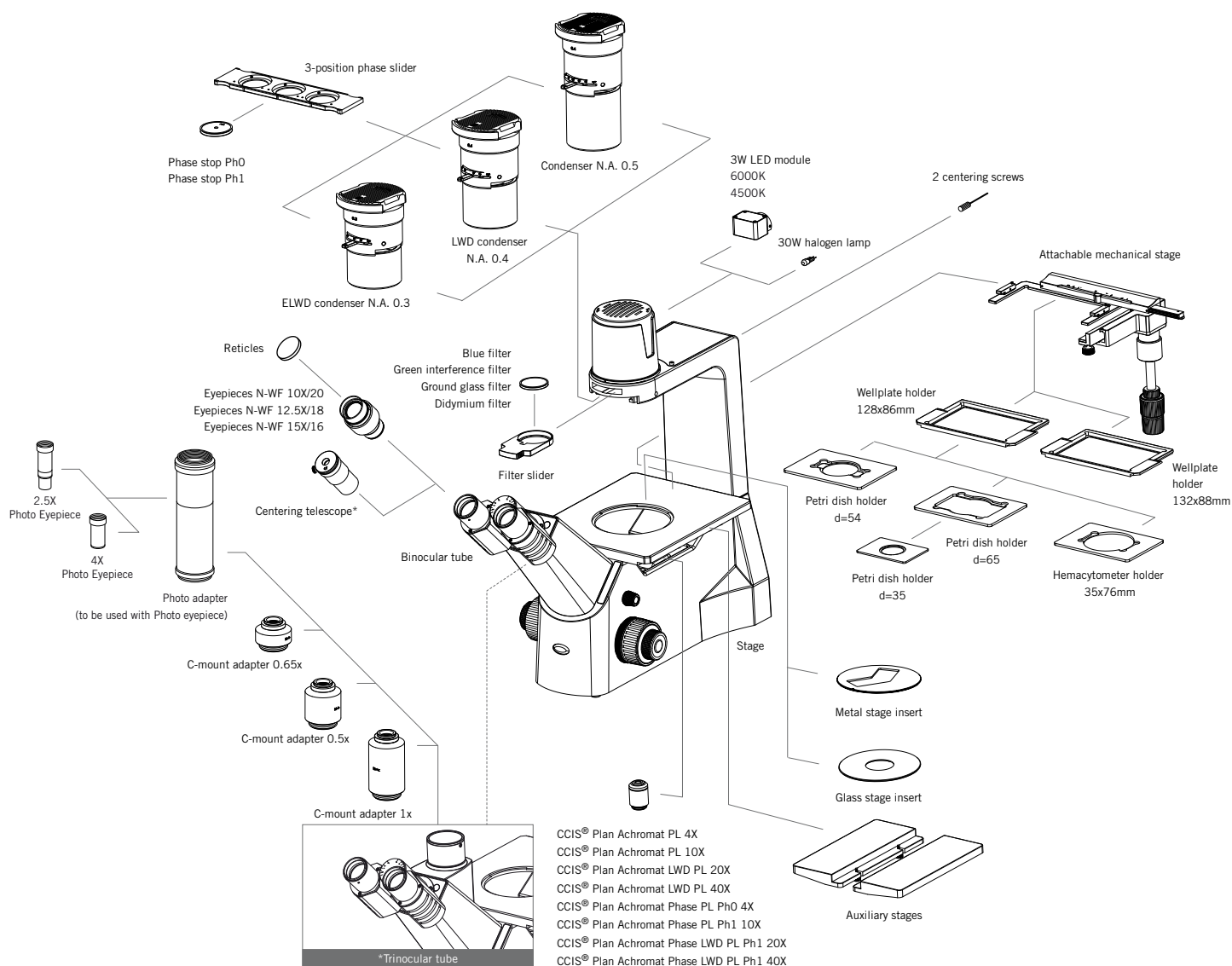
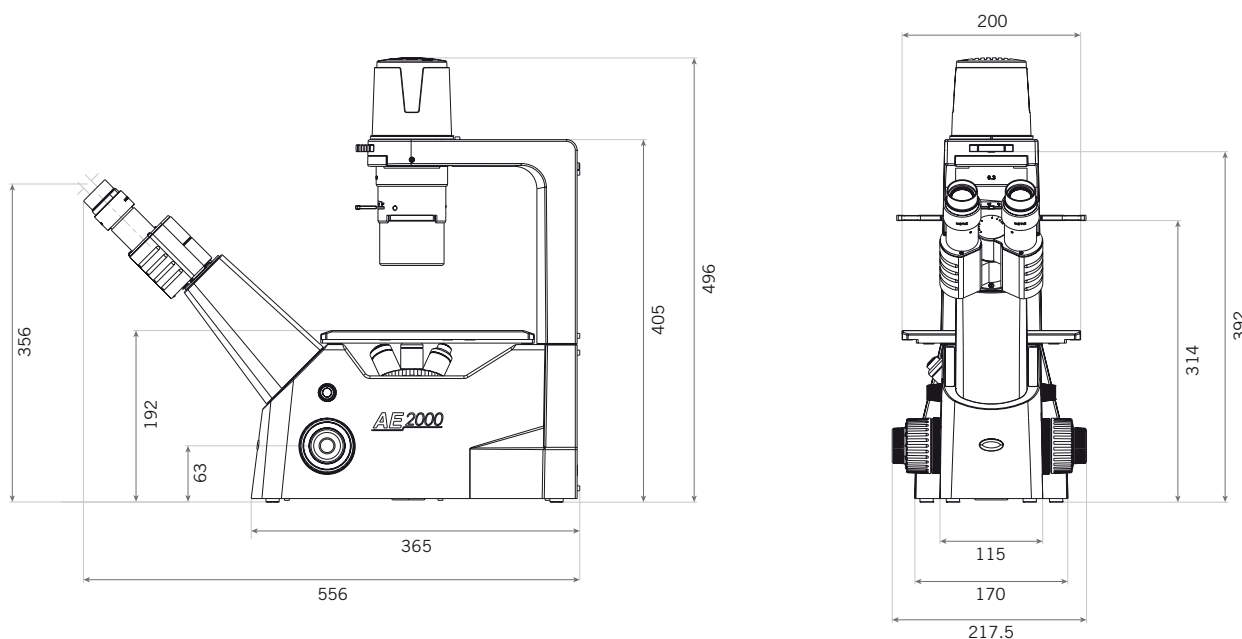

\*Tube version (binocular; trinocular) is an integral part of the respective microscope model and not interchangeable.



Canada | USA | Europe | China



[www.moticmicroscopes.com](http://www.moticmicroscopes.com)

**Motic Instruments, Inc. (Canada)**

130-4611 Viking Way, Richmond, BC V6V 2K9 Canada  
Tel: 1-877-977-4717 | Fax: 1-604-303 9043  
info@motic-america.com

**Motic Instruments USA Inc.**

6508 Tri-County Parkway Schertz, TX 78154 USA  
Tel: 1-800-275-3716

**Motic Europe (Spain)**

C. Les Corts 12, Pol. Ind. Les Corts. 08349 Cabrera de Mar, Barcelona, Spain  
Tel: 34-93-756 6286 | Fax: 34-93-756 6287

**Motic Incorporation Ltd. (Hong Kong)**

Unit 2002, L20, Tower 2, Enterprise Sq. 5, 38 Wang Chiu Rd, Kowloon Bay, Kowloon  
Tel: 852-2837 0888 | Fax: 852-2882 2792

Design Change: The manufacturer reserves the right to make changes in instrument design in accordance with scientific and mechanical progress, without notice and without obligation.

Motic Incorporation Limited Copyright © 2002-2019. All Rights Reserved.

Updated: October 2019

