

Operating instructions

METTLER TOLEDO PR/SR balances

METTLER TOLEDO

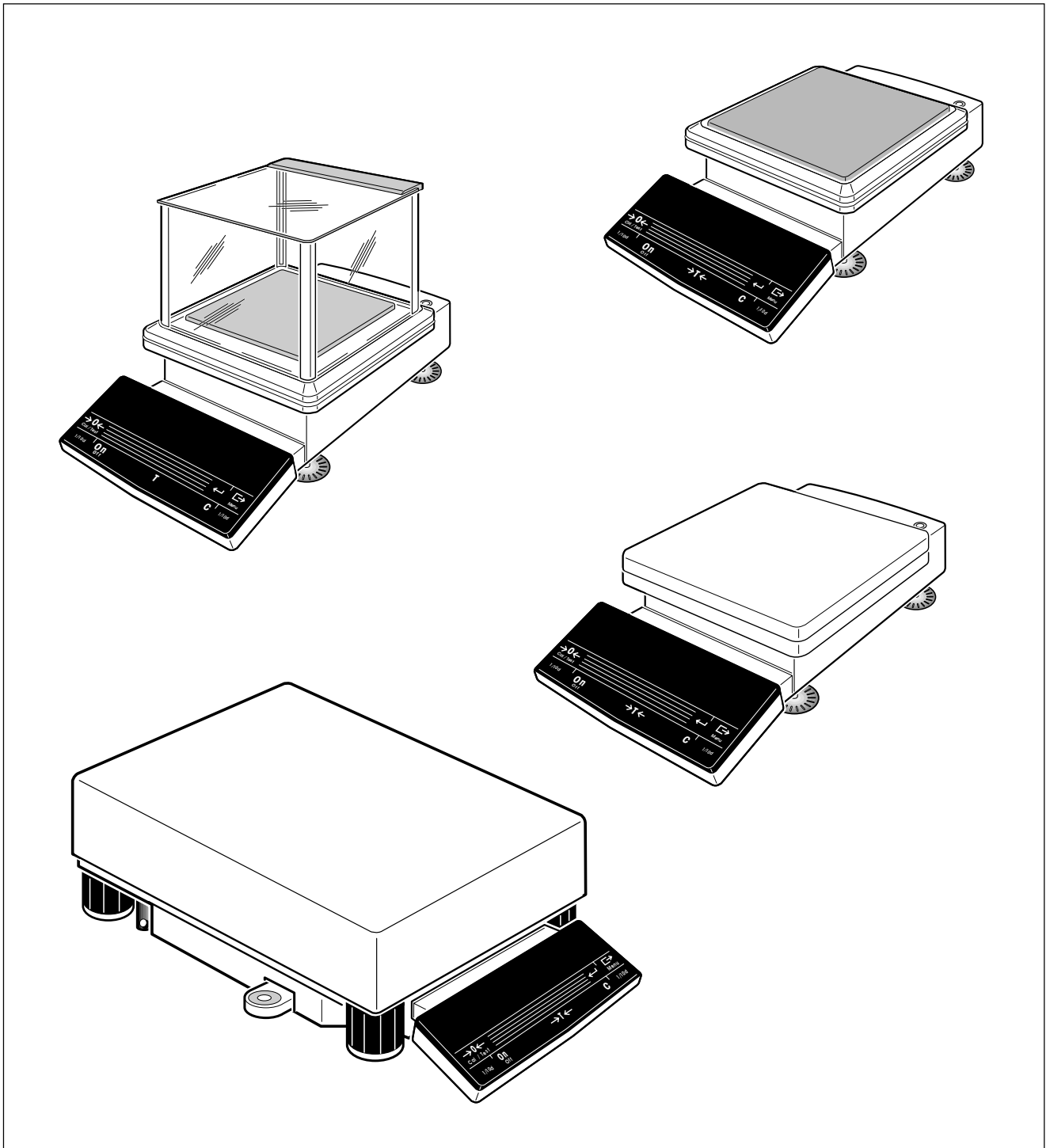

Dear customer

Many congratulations on your purchase of a new balance of the PR/SR series from METTLER TOLEDO. You have acquired a balance which will meet the very highest weighing and quality demands regarding accuracy, function and processing. It allows you to fulfill the exacting requirements of the quality systems following ISO or GLP/GMP and at the same time to simplify the work procedures in your daily weighing tasks. The PR/SR balances are thus among the most powerful weighing instruments on the market.

With our worldwide sales and service network, we can offer you our wide range of know-how in the field of analytical instruments and balances as a follow-up to your purchase. Thanks to service engineers trained by us, we are in a position to assure you of unvarying quality of our products for years to come.

Should you desire further information on your balance, its application or expansion to a weighing station, contact your METTLER TOLEDO dealer, who will be more than pleased to help you.

I wish you every success in your work with your new balance.

Yours sincerely

Mettler-Toledo GmbH
Laboratory & Weighing Technologies



Mario Hochstrasser
General Manager

Contents	Page
1 Getting to know the PR/SR balances	4
1.1 Introducing the PR/SR balances	4
1.2 Unpacking / Standard equipment	5
1.3 Layout	5
1.4 Key assignment	6
1.5 Display field	8
1.6 Model designation list	8
2 Startup procedure	9
2.1 Cautionary notes	9
2.2 Setting up	9
2.3 Leveling	11
2.4 Connecting to the power supply	12
2.5 Calibrating balance (adjustment)	13
2.6 Testing balance	16
2.7 Determining the repeatability	18
3 Weighing – basic functions	20
3.1 On / off switching	20
3.2 Simple weighing	20
3.3 Zero setting and taring	21
3.4 Weighing with the analog display – METTLER DeltaTrac	22
3.5 Weighing with DeltaRange balances with movable fine range	22
3.6 Quicker weighing with reduced readability	23
3.7 Recording / printing data	23
3.8 Working with the SmartBar	24
3.9 Alphanumeric entry using the SmartBar	25
3.10 Entry with bar-code reader or external keyboard	27
4 Extended basic functions	28
4.1 Header printout – " Header "	28
4.2 Series identification – " LotID "	29
4.3 Sample identification – " SampleID "	29
4.4 Entering a fixed tare weight – " PreTare "	30
4.5 Switching units – " Unit2 ", " CustomUnit "	32

5	Applications	33
5.1	Dynamic weighing with statistics – " Dynamic "	33
5.2	Piece counting – " Count "	38
5.3	Totalization – " Tot "	42
5.4	Plus/minus statistics – "+/-Stats"	47
5.5	Formulation – " Formula "	56
6	Menu	61
6.1	Selecting weighing application – " APPL "	67
6.2	Setting weighing parameters – " WEIGH "	72
6.3	Selecting the calibration (adjustment) and test function – " CAL "	79
6.4	Balance settings – " SYSTEM "	82
6.5	Setting the language – " LANGUAGE "	89
7	LocalCAN universal interface, technical data and optional equipment	90
7.1	LocalCAN universal interface	90
7.2	Technical data of the PR/SR balances	91
7.3	Optional equipment	101
8	Appendix	103
8.1	Inquiry of software version numbers	103
8.2	Parameter settings and admissible values	104
8.3	Messages in the display	108
8.4	Adjustment of the internal calibration	110
8.5	Maintenance	112
8.6	Changing the fuse (only with balances with built-in power supply unit)	113
8.7	Changing the battery	114
8.8	SOP (Standard Operating Procedure)	115
8.9	Index	117

1 Getting to know the PR/SR balances

1.1 Introducing the PR/SR balances

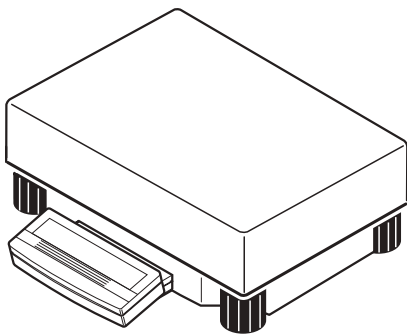
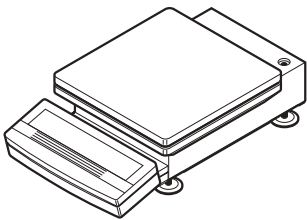
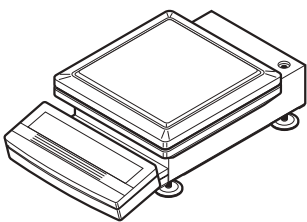
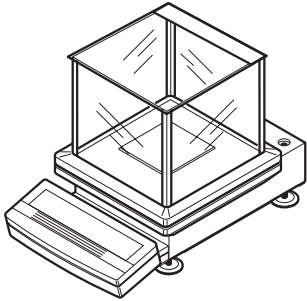

PR/SR balances are high-quality precision balances with readabilities from 1 mg to 1 g. The weighing ranges span 200 g to 8 kg in the case of the compact PR models. For the SR models with detachable terminal, the ranges span 8 kg to 64 kg. Thanks to their numerous functions, PR/SR balances can not only be used for weight determination. You can employ your balance in a wide range of weighing applications in a simple fashion with unmistakable documentation of the measurement results.

The most important features

- **Fully automatic and/or time-controlled self-calibration (adjustment) proFACT**
proFACT assures the high accuracy of your weighing results at all times, even under changing ambient conditions.
- **Simple operation with the SmartBar key field**
With the SmartBar you always have precisely those functions you need for your current weighing task.
- **Result recording conforming to GLP**
Thanks to the alphanumeric input possibility offered by the SmartBar and the corresponding display, you can provide results with a freely selected name as well as the current date and time to identify them unambiguously. Each adjustment and each test of the balance can also be automatically recorded.
- **Graphic display of the METTLER DeltaTrac**
This easily readable analog display supports you in weighing-in and in weight checks.
- **Built-in LocalCAN universal interface**
LocalCAN not only allows you to attach a printer or computer with an RS-232C interface or an auxiliary display and a bar-code reader, but all these peripherals **at the same time**. You can thus expand your balance when required to a convenient weighing station.

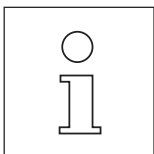

- METTLER TOLEDO **DeltaRange** balances also have a movable fine range with 10 times higher resolution. You will find further details in section 3.5.
- PR/SR balances are also available in a **certified version**. Ask your METTLER TOLEDO dealer for details.
- For special applications, e.g. space-saving installation in a machine, PR/SR balances are also available without a terminal. They are then operated via the built-in interface with a powerful set of commands.
- If you wish to build on what you have learned about weighing in these operating instructions, you will find valuable tips in the booklet "Weighing the right way" 720906.

1.2 Unpacking / Standard equipment

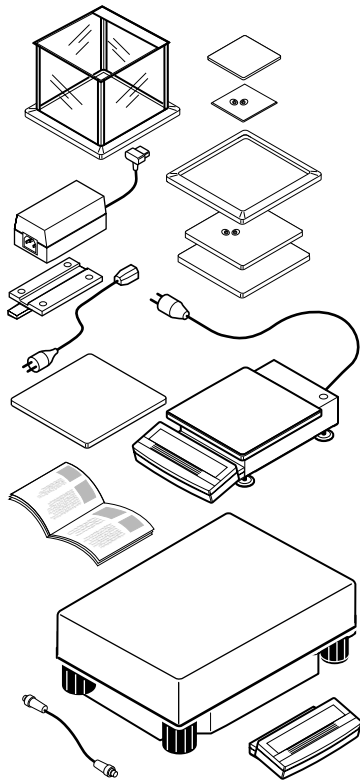

PR/SR balances are supplied in an environmentally friendly package.

→ Check the standard equipment for completeness.

PR balances with readability 1 mg

- Operating instructions
- Weighing pan support
- Weighing pan
- Draft shield

PR balances with readability 10 mg

- Operating instructions
- Weighing pan support
- Weighing pan
- Draft shield element

PR balances with readability 0.1 g* and 1 g

- Operating instructions
- Weighing pan support
- Weighing pan

* Type of construction of 0.1 g certified version corresponds to that of 10 mg model

Additional equipment for PR balances with separate power supply unit

- Power cable
- AC adapter
- Holder for AC adapter

SR balances

- Operating instructions
- Weighing pan
- Terminal with holder
- Terminal connection cable

1.3 Layout

The control unit (terminal) of the PR/SR balances is separated from the base unit to facilitate your operation and loading of the balance.

The terminal with its display and keypad is identical for all PR/SR balances. The size of the weighing pan depends on the readability and maximum capacity of the balance.

- 1 Keypad
- 2 Display field
- 3 Weighing pan
- 4 Leveling control
- 5 Power cable
- 6 Stand fastening
- 7 Provision for anti-theft device
- 8 Attachment for the LocalCAN universal interface
- 9 Leveling feet
- 10 Draft shield
- 11 Draft shield element
- 12 Model plate
- 13 Model designation
- 14 AC adapter
- 15 Holder for AC adapter
- 16 Power cable for AC adapter

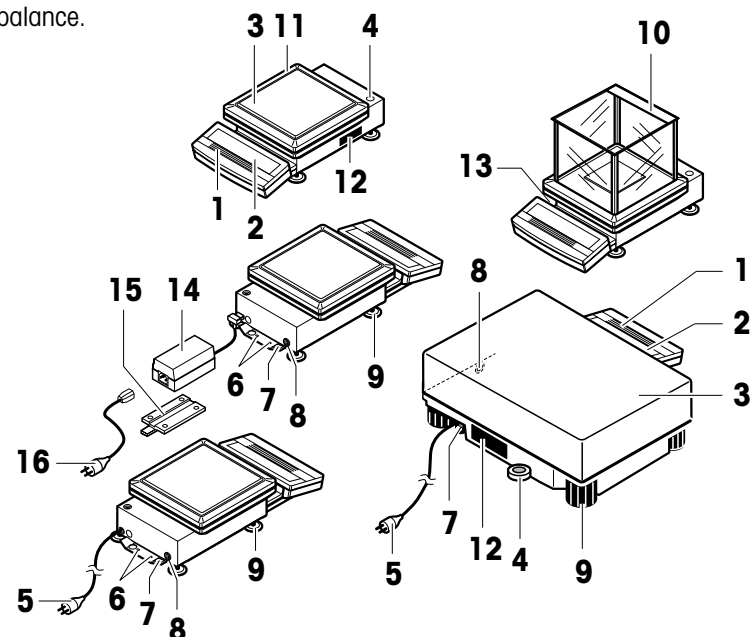

1.4 Key assignment

The keypad of the PR/SR balances comprises a variable key field, the SmartBar, and the dedicated or labeled keys.

The SmartBar

The most important and versatile key field of the PR/SR balances is the SmartBar. Its configuration changes in accordance with the weighing task and facilitates your operation of the balance. You can discover the current configuration from the bottom line of the display directly above the SmartBar.

You can use the SmartBar to

- set balance parameters and applications,
- select the parameters of an application,
- call up or execute functions,
- assign alphanumeric identifications,
- preset numeric values such as date, time and target weight values.

Dedicated keys

A **brief** keystroke activates the **main function** of the key, which is printed in **large** letters.

Pressing and holding the key activates the **auxiliary function** of the key, which is printed in **smaller, green** letters.

Pressing and holding a key is shown by the **symbol**  in these operating instructions.

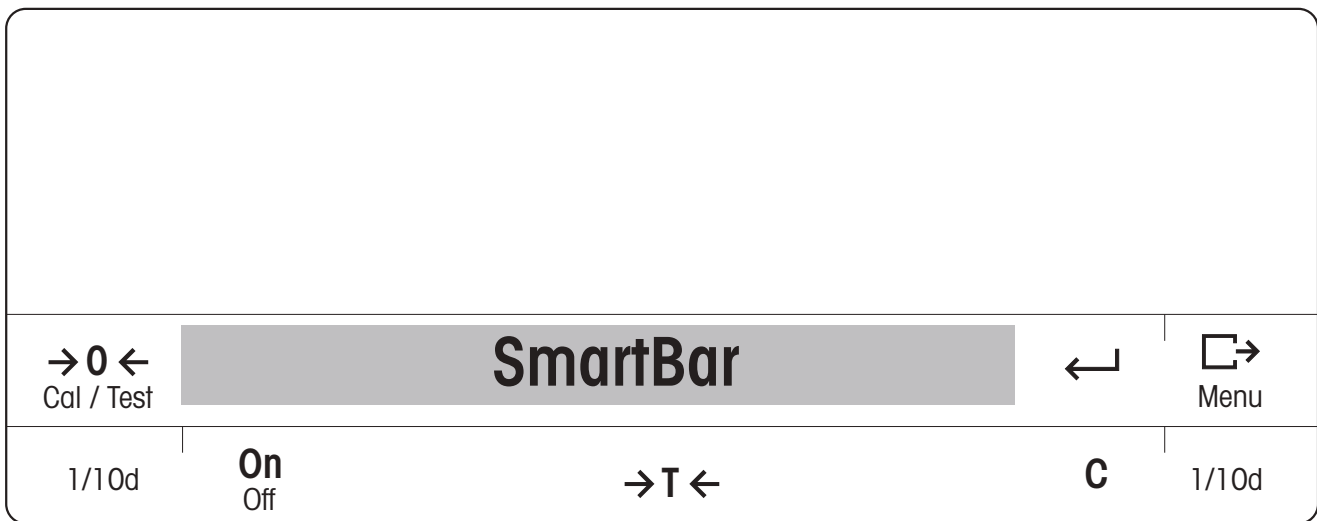

When the balance is switched on, there are two operating modes.







1. Weighing mode

Mode after switching on in which you weigh or use one of the weighing applications (sections 3, 4 and 5).



2. Menu

Here you can match the PR/SR balance to your needs or your weighing task, change the weighing behavior of the balance or set basic parameters (section 6).

In some cases, the function of the dedicated keys differs in accordance with the mode.

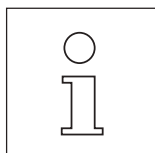
Weighing mode		Key	Menu	
Press briefly	Press and hold 		Press briefly	Press and hold 
<ul style="list-style-type: none"> • Taring • With entries: cancel entry 	<ul style="list-style-type: none"> • Switch off balance 	On Off  C	<ul style="list-style-type: none"> • Quit menu without saving settings 	<ul style="list-style-type: none"> • Quit menu without saving settings, switch off balance
<ul style="list-style-type: none"> • Zero setting 	<ul style="list-style-type: none"> • Calibration (adjustment or initiating test) 	 Cal / Test	<ul style="list-style-type: none"> • No function 	<ul style="list-style-type: none"> • No function
<ul style="list-style-type: none"> • No function 	<ul style="list-style-type: none"> • Suppress or call up last decimal place 	1/10d	<ul style="list-style-type: none"> • No function 	<ul style="list-style-type: none"> • No function
<ul style="list-style-type: none"> • Confirm entry and return to weight display 	<ul style="list-style-type: none"> • Confirm entry and return to weight display 		<ul style="list-style-type: none"> • Confirm entry and return to last display 	<ul style="list-style-type: none"> • Confirm entry and return to last display
<ul style="list-style-type: none"> • Print out displayed value 	<ul style="list-style-type: none"> • Enter menu 	 Menu	<ul style="list-style-type: none"> • Confirm entry and return to start of menu 	<ul style="list-style-type: none"> • Save menu settings and return to weighing mode



- You can initiate the functions on/off switching (**On**_{Off}), taring () and cancel (**C**) over the entire width of the corresponding key field. If the balance is switched off, but connected to the power supply, only the  key is active. Pressing this key briefly switches the balance on ("On" function).
- All **actions** that you as the user have to perform at the balance such as loading the balance are **marked by →** in these operating instructions.

1.5 Display field

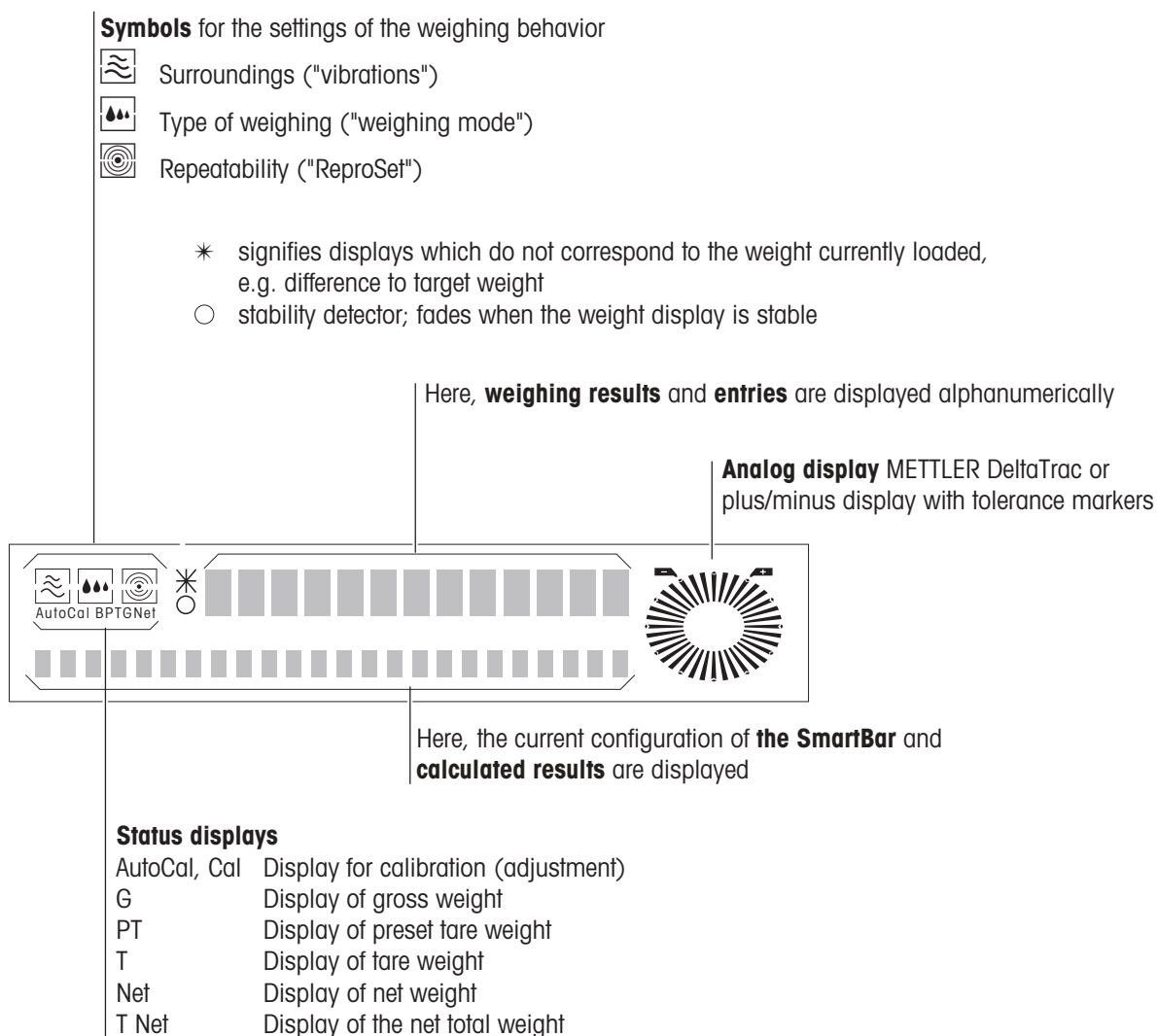

1.6 Model designation list

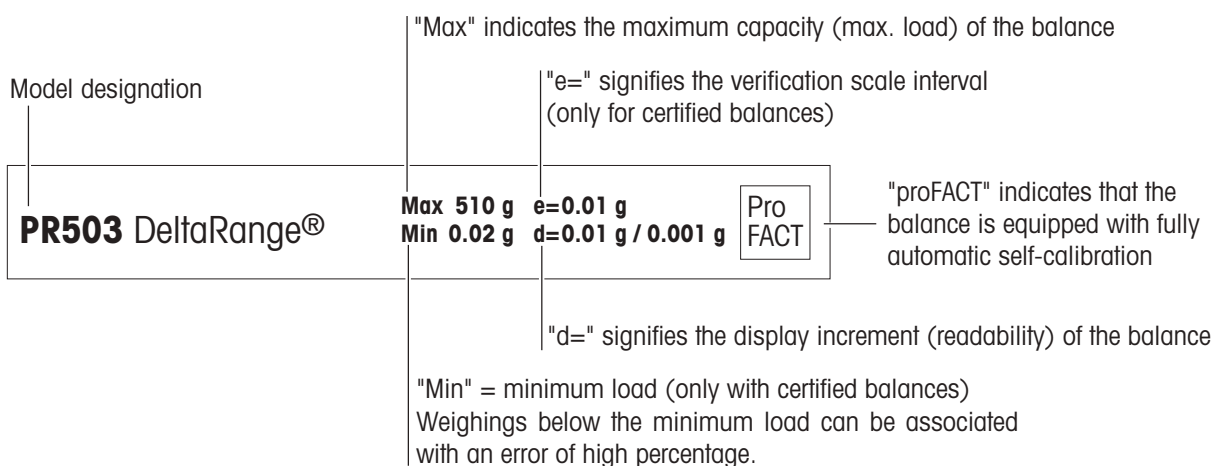

2 Startup procedure

2.1 Cautionary notes



- PR/SR balances may only be used indoors.
- Never operate PR/SR balances in hazardous areas.
- Operate PR/SR balances only when connected to receptacle outlets with a ground connection.
- PR/SR balances with built-in power supply unit can be made dead only by disconnecting the power plug. The receptacle outlet must thus be near the balance and readily accessible.
- In the case of PR balances with a separate power supply, use only the AC adapter supplied. The voltage value printed on the adapter must match the local line voltage.
- Electronics and measuring cells of the PR/SR balances are protected against the ingress of water and dust, but they are not absolutely tight.
- Never operate PR balances in surroundings which are always humid or extremely dusty.
- In the case of SR balances, operation in humid or dusty surroundings is possible provided the balance is carefully maintained.
- Follow cleaning instructions (section 8.5). Protect power plug to ensure it never gets wet.
- Never open your balance. Should you have problems with your balance on the odd occasion, please contact your responsible METTLER TOLEDO dealer.

2.2 Setting up

The optimum location for precise weighing

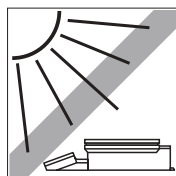
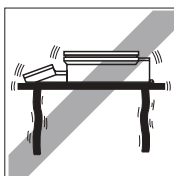

Proper location of high-resolution balances is one of the decisive factors affecting the accuracy of the weighing results. Hence, pay attention to the following points:

- stable, vibration-free support as horizontal as possible,
- no direct sunlight,
- no excessive temperature fluctuations,
- no drafts.

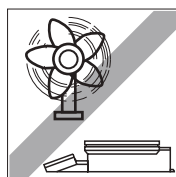
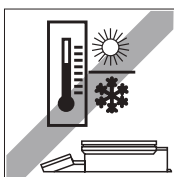

The best location is a stable bench in a corner protected against drafts and as far as possible from doors, windows, heating systems or ventilation slots of air conditioning units.

If vibrations can not be avoided, the balance can still provide precise results if it is matched to its environment (see section 6.2).

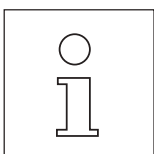

Influence of ambient conditions on the weighing sample

Ambient conditions not only influence the informative value of the measurement results with regard to accuracy, but can also have an effect on the mass of the weighing sample.

- The atmospheric humidity influences the mass, e.g. by a film of moisture, by water absorption in the case of hygroscopic weighing samples or through sample desiccation.

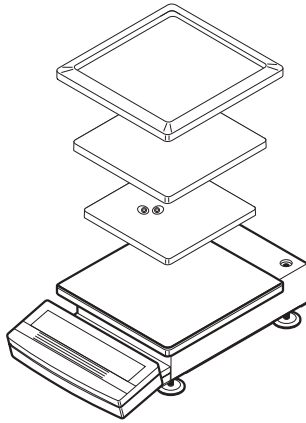

Setting up the balance

PR balances with draft shield or draft shield element (readability 1 mg or 10 mg)

- Mount weighing pan support.
The weighing pan support is protected against distortion.
- Mount weighing pan.
- Mount draft shield or draft shield element.

PR balances with large weighing pan (readability 0.1 g or 1 g)

- Mount weighing pan.

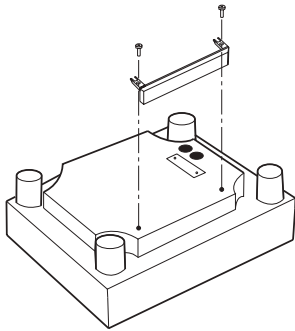

SR balances

- Remove balance, weighing pan and terminal from package.

Mounting terminal on balance

- Remove buffer protecting strip.
- Fasten terminal with screws of the detached buffer protecting strip.
- Plug connection cable into the balance and the terminal.
- Insert connection cable in the cable channel provided.
- Mount weighing pan, detach protective cover.

Mounting terminal separately

- Unscrew separator from terminal.
- Retighten screws to ensure continued protection against wet conditions.
- Plug connection cable into balance and terminal.
- Mount weighing pan, remove protective cover.

Anti-theft device of PR/SR balances

PR/SR balances have provision for an anti-theft device. When the anti-theft device is fitted (see Optional equipment, section 7.3), PR/SR balances can be protected against theft.

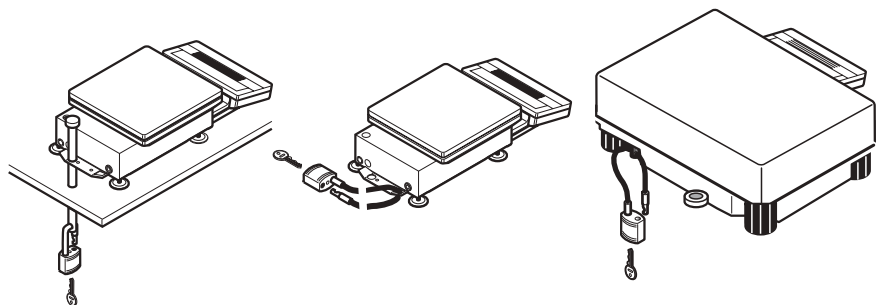

2.3 Leveling

Exact horizontal positioning of high-resolution balances is a prerequisite if reproducible weighing results are to be obtained at all times. PR/SR balances thus have a leveling control (level) and adjustable leveling feet to compensate slight irregularities in the surface of the balance location. The balance is exactly horizontal when the air bubble (1) is in the middle of the level.

Procedure with PR balances

With PR balances, you need **only align the two front leveling feet**.

The imprint surrounding the level makes the leveling of PR balances particularly simple.

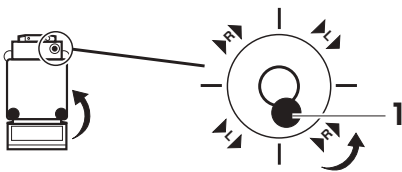

→ Turn the **two front** leveling feet as shown in the imprint or illustration until the air bubble is in the middle of the level.

If, for instance, the air bubble is at the bottom right, ►R► in the imprint signals that you must turn the **R**ight front leveling foot in the direction of the arrow (counterclockwise).

Several leveling steps are usually necessary.

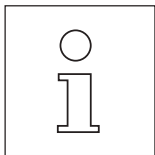

- The balance must be releveled each time it is moved to a new location.
- If you work with heavy loads and wish to obtain results with the highest possible accuracy, the two rear leveling feet of the PR balances must be unscrewed until they touch the bench surface.

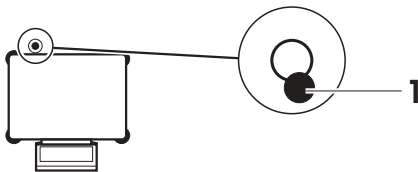

Procedure with SR balances

→ Screw in one of the four leveling feet as far as it will go.

Level balance using the **three** remaining leveling feet, which should be at the same level.

Unscrew the leveling foot first screwed in until it touches the supporting surface.

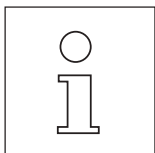

The balance must be releveled each time it is moved to a new location.

2.4 Connecting to the power supply



- PR/SR balances can be made dead only by disconnecting the power plug. The receptacle outlet must therefore be near the balance and readily accessible.
- Protect AC adapter and power plug against moisture and wet conditions.
- PR/SR balances may be operated only when connected to receptacle outlets with a ground connection.

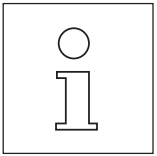

- PR/SR balances with built-in power supply unit automatically adjust themselves to a line voltage between 100 V~ and 240 V~ (50/60 Hz).
- In the case of PR balances with a separate AC adapter, the voltage value printed on the AC adapter must match the local line voltage.



Connecting PR balances with built-in power supply

- Connect balance to power supply.

The balance performs an extended display and self-test. The test is at an end when "OFF" appears in the display.

Connecting PR balances with separate AC adapter

- Check the AC adapter to ensure the voltage value printed on it matches the local line voltage.
- Connect AC adapter to balance and power supply.

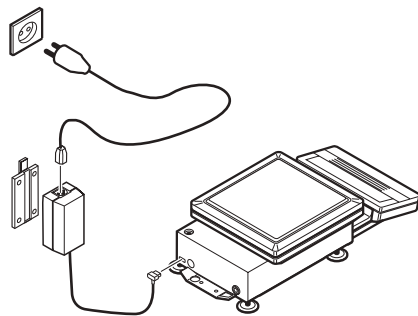

Holder for AC adapter

You can install the AC adapter in a fixed position using the holder supplied.

- Fasten holder with 2 screws to a suitable, sufficiently stable surface, e.g. on the wall or the underside of a bench top.
- Press AC adapter into holder.
- Connect AC adapter to balance and to power supply.

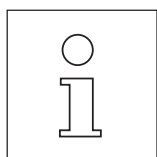

The AC adapter can be removed from the holder by pressing the protruding lug.

2.5 Calibrating balance (adjustment)

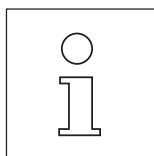

PR/SR balances offer you various possibilities to calibrate or test the balance. In the menu (section 6.3) you can choose between

- calibrating (adjustment) or testing the balance,
- internal or external weights,
- automatic and/or time-controlled as well as manual initiation of the adjustment operation.

In addition, the last 50 adjustment operations can be displayed or printed out if a printer is attached.

```

- BALANCE CALIBRATION --
17.06.95          10:36:04
METTLER TOLEDO
Type:             PR5002DR
SNR:              1114051374
Bal:              Your entry

Int. calibration done
----- END -----

```

Factory setting is fully automatic and time-controlled calibration (adjustment) with an internal weight proFACT (Professional Fully Automatic Calibration Technology). In this setting, you do not need to worry about calibrating (adjustment) your balance.

The balance calibrates (adjusts) itself automatically

- after the warm-up phase following connection to the power supply,
- with certified balances: immediately after switching on from the "OFF" condition (after a power outage),
- if a change in the ambient conditions, e.g. temperature could lead to an appreciable deviation in the measurement,
- weekdays at 12.00 a.m.

If a printer, e.g. the LC-P43 from METTLER TOLEDO is attached, the adjustment procedure can be recorded automatically and in conformance with GLP, see section 6.3.

Sequence of the calibration (adjustment) of the balance with an internal weight**Requirement**

The calibration setting in the menu corresponds to the factory setting "proFACT" (see section 6.3).

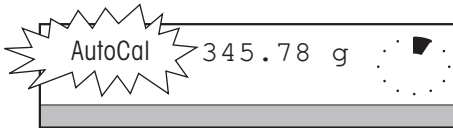

If the balance wishes to calibrate (adjust) itself, "AutoCal" flashes in the display.

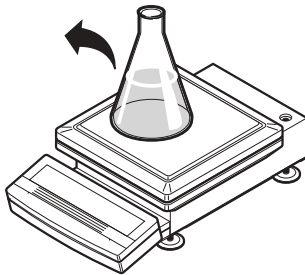

→ On completion of the current weighing series or when the work allows, remove any load from weighing pan.



After a few minutes, the calibration (adjustment) is triggered automatically by the balance.

Or

→ initiate the calibration (adjustment) manually by pressing and holding the  key and by pressing the SmartBar under the word "Calibration".

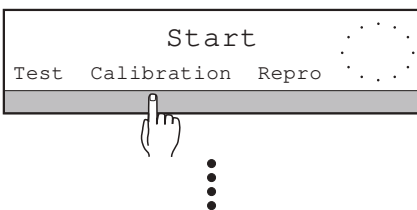

During the calibration, "BALANCE CALIBRATION" appears in the bottom line of the display.



Finally, a completed calibration (adjustment) is confirmed by "Cal done" and the balance returns automatically to the weighing mode. A tare value displayed before the calibration reappears in the display.

```

- BALANCE CALIBRATION --
17.06.95      10:57:59
METTLER TOLEDO
Type:        PR5002DR
SNR:         1114051374
Bal:         Your entry

Int. calibration done

Signature:

.....
----- END -----

```

If a printer is attached, the adjustment can be recorded automatically, see section 6.3.

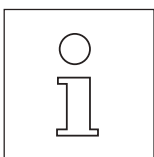

- You can terminate the calibration procedure at any time by pressing the **C** key.
- "Signature" appears on the printout if the calibration was started using the keypad.
- Within a weighing series (item counter $n > 0$), the calibration is not initiated automatically, but it can be started using the  key.

Sequence of the calibration (adjustment) of the balance with external weights Requirement

The key word "VariCal" is marked under "Calibration" in the "CAL" menu (see section 6.3).

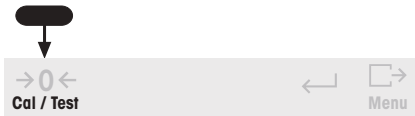

→ Trigger the calibration (adjustment) by pressing and holding the $\rightarrow 0 \leftarrow$ key and by pressing the SmartBar under the word "Calibration".



"BALANCE CALIBRATION" appears in the bottom line of the display.

After a short time, the balance flashes the weight value it needs for calibration (adjustment). It is the weight value selected (marked) in the menu.



→ Place weight whose value flashes in the top line of the display in center of weighing pan. The balance is calibrated (adjusted).



→ When zero flashes in the display, remove weight.



Finally, a completed calibration (adjustment) is confirmed by "Cal done" and the balance returns automatically to the weighing mode. A tare value displayed before the calibration reappears in the display.

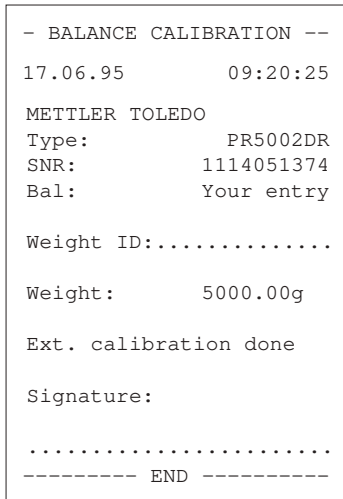

If a printer is attached, the adjustment can be recorded automatically, see section 6.3.

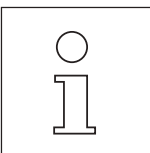

- You can terminate the calibration procedure at any time by pressing the **C** key.
- If you have activated the word "VariCal" under "CAL" in the menu (section 6.3), "Cal" flashes in the display to signal that the balance has determined a noticeable change in the ambient conditions and should thus be calibrated (adjusted).
- You will find further details regarding selection of the calibration (adjustment) in section 6.3.

2.6 Testing balance

The "Test" function, which you can call up by pressing and holding the $\rightarrow 0 \leftarrow$ Cal/Test key, allows you to check the accuracy of your PR/SR balance at any time. The deviation from the target value determined by the balance is displayed and recorded in conformance with GLP. You have a choice of two methods here:

- Checking with an internal (built-in) weight; here, the test point is fixed, or
- Checking with an external weight whose value can be freely entered within the load range of the balance.

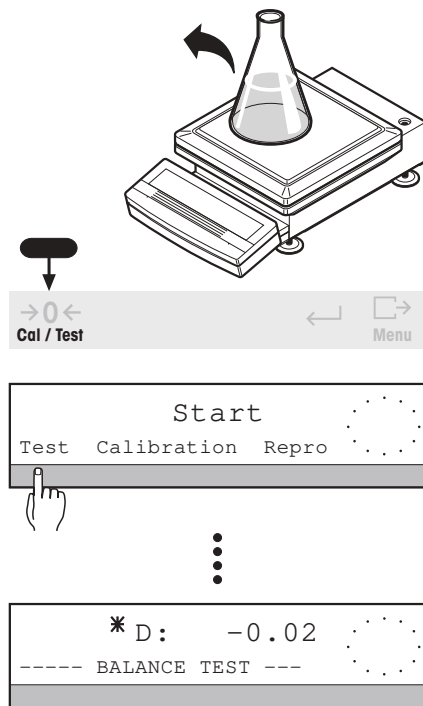

Procedure for testing the balance with the internal weight

Requirement

The setting of the test function under "CAL" in the menu corresponds to the factory setting (see section 6.3).

→ Remove any load from the weighing pan.

→ Initiate test with pressing and holding the $\rightarrow 0 \leftarrow$ Cal/Test key and by pressing the SmartBar under the word "Test".

During the test, "BALANCE TEST" appears in the bottom line of the display.

When the test is complete, the difference between the actual value and the target value appears for a few seconds in the top line of the display marked by "*" and "D". The balance then returns automatically to the weighing mode. A tare value displayed before the test reappears in the display.

If a printer is attached, e.g. LC-P43 from METTLER TOLEDO, the test result is automatically printed out.

```

----- BALANCE TEST -----
17.06.95      11:03:06
METTLER TOLEDO
Type:         PR5002DR
SNR:          1114051374
Bal:          Your entry

Target  :    800.00
Actual  :    799.98
Diff    :    -0.02

Internal test done

Signature:

.....
----- END -----

```

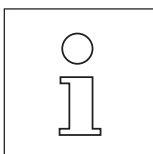

- You can terminate the test at any time by pressing the **C** key.
- The deviation determined by the balance depends on the ambient conditions!

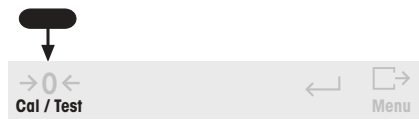

```

----- BALANCE TEST -----
17.06.95      11:27:16
METTLER TOLEDO
Type:         PR5002
SNR:         1114051375
Bal:         Your entry

Weight ID:.....

Target  :    1999.98 g
Actual  :    1999.95 g
Diff    :     -0.03 g

External test done

Signature:
.....
----- END -----
    
```

Procedure for testing the balance with external weights

Requirement

The key word "External" is marked under "CAL -> Test" in the menu (see section 6.3).

→ Initiate test by pressing and holding the  key and by pressing the SmartBar under the word "Test".

During the test, "BALANCE TEST" appears in the bottom line of the display. After a short time, the balance flashes the preset target weight it needs for the test in the display (section 6.3).

→ Place weight whose value flashes in the top line of the display in the center of the weighing pan. The balance is tested.

→ When zero flashes, remove weight from weighing pan. When the test is complete, the difference between the actual value and the preset target value appears in the top line marked by "*" and "D". The balance then returns automatically to the weighing mode. A tare value displayed before the test reappears in the display.

If a printer is attached, the test result is printed out automatically.

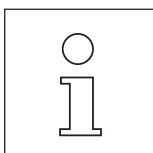

- You can terminate the test at any time by pressing the **C** key.
- The deviation determined by the balance depends on the ambient conditions and the setting of the balance parameters under "Weight" in the menu, particularly on the setting of the repeatability "Repro"!
- If immediately following a calibration (adjustment) with the internal weight the difference to your weight standard is greater than that specified under "long-term stability" in the technical data, you can configure your balance to your weight (see Appendix, section 8.4).
- Flashing of the status display "AutoCal" or "Cal" signals that the balance should be calibrated and is stopped by the check.

2.7 Determining the repeatability

The "ReproCheck" function offers you a statistical determination of the repeatability of the balance at its location. Through repeated measurement of a single sample you can determine the quality, i.e. the uncertainty of the measurement. Influences on the result of this measurement include on the one hand the balance environment and on the other hand the internal balance repeatability "ReproSet" in the menu option "Weighing" (see section 6.2.3).

With this function you determine

- the ideal location,
- the minimum sample weight,
- the optimum configuration of your balance at its location.

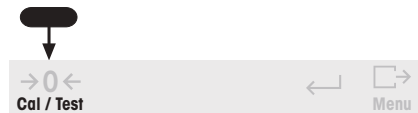

Procedure

→ Press and hold the $\rightarrow 0 \leftarrow$ key until the display changes.



→ Press the SmartBar under "Repro".

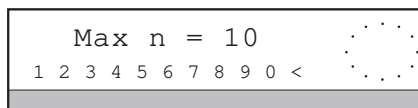

→ Enter the number n of repetitions numerically and confirm with \leftarrow . Possible values: 3 ... 10. If the entry is outside the admissible range, the message "Illegal value" appears.

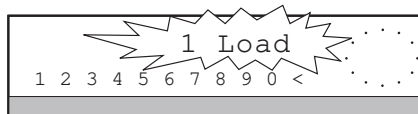

→ The balance display flashes to prompt you to load the sample for the first time.

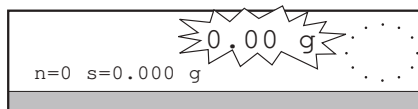

→ When zero flashes in the display, remove the sample.

→ Reload the sample.

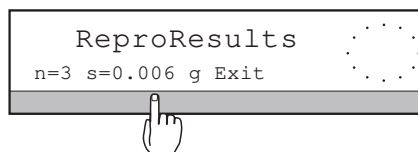

→ After the sample has been loaded n times, the display "ReproResults" appears. Press the SmartBar under "s= ..." to obtain the following values:

"s" Standard deviation

"srel" Relative standard deviation (standard deviation in % of the calculated mean value $srel = \frac{s}{\bar{x}}$)

" \bar{x} " Mean value

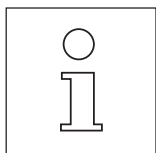

- You can terminate the procedure at any time with the **C** key.
- The greater the number of repetitions, the more reliable the result.

```

----- REPRO CHECK -----
03.01.96          09:20:25

METTLER TOLEDO
Type:             PR5002
SNR:             1114051374
Bal:             Your entry
ReproSet         Good

1                1.11 g
2                1.10 g
3                1.10 g
n                3
x                1.103 g
s                0.006 g
s rel            0.52 %

Signature:

.....
----- END -----

```

If a printer is attached, the result is automatically recorded. The printout also shows the "ReproSet" setting specified in the "Weighing" menu (see section 6.3.2).

Determining the minimum sample weight at the location of the balance

If your measured values have to comply with particular tolerance systems (e.g. pharmacopoeia), you can determine the minimum sample weight which allows you to meet these requirements at the balance location.

For this you consider the relative standard deviation *srel*, which indicates the percentage error in the measured value. The standard deviation *s* is not suitable for this purpose as it shows only the deviation for the particular weight value.

Weight	s	srel
10.0 g	0.01 g	0.1%
1.0 g	0.01 g	1.0%

Example 1

Same standard deviation *s*, but different percentage errors *srel*, depending on the sample weight.

Weight	s	srel
10.0 g	0.01 g	0.1%
1.0 g	0.001 g	0.1%

Example 2

Same percentage error *srel* despite different sample weights and different standard deviations *s* of the individual measured values- The absolute standard deviation *s* is thus not suitable for the comparison of the quality of measured values.

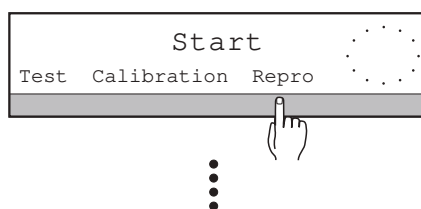

Procedure

- For all sample weights, define a relative standard deviation (for instance, *srel* should always be less than 0.1%).
- Perform the ReproCheck function several times and systematically lower the weight of the test specimen to determine the weight at which you are below the defined relative standard deviation.
- If you can not achieve the specified accuracy, you can adapt the repeatability under "ReproSet" in the "Weighing" menu (see section 6.2.3) to improve the relative standard deviation.
- If the results are still unsatisfactory, change the conditions at the balance location. For example, use a draft shield or place the balance on a special weighing table to minimize the influence of external disturbances.

3 Weighing – basic functions

3.1 On / off switching



Switching on

1st possibility with **On**_{Off} key

→ Press **On**_{Off} key briefly.

When "0.00 g" appears in the display, the balance is ready for operation. For your information, the bottom line of the display shows the current weighing application, e.g. "SIMPLE WEIGHING".

→ Press any key briefly. The current configuration of the SmartBar is displayed.

2nd possibility with loading the balance ("QuickStart")

→ Switch the balance on by placing a load of at least 10 grams on the weighing pan.

In this case, the total weight is shown immediately.

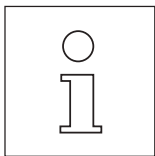

- If you use the setting "QuickStart" (section 6.4), the current total weight (gross weight) is automatically displayed after a loaded balance has been switched on with the **On**_{Off} key.
- In addition to "QuickStart", you can set other startup routines in the menu (see section 6.4).

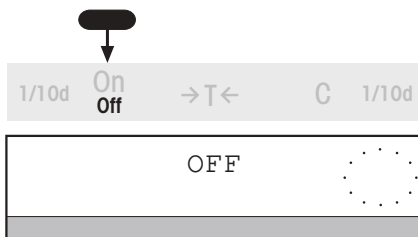

Switching off

→ Press and hold **On**_{Off} key until "OFF" appears in the display. Release key.

→ The display fades. If the balance remains connected to the power supply, there is no need for a warm-up phase the next time it is switched on.

3.2 Simple weighing

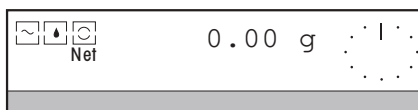

→ Tare balance with →T← key (see also section 3.3).

→ Place weighing sample in center of weighing pan.

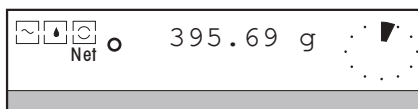

→ Wait until the stability detector (o) fades.

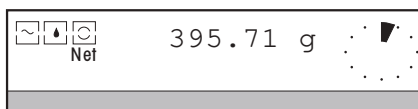

→ Read off result.

3.3 Zero setting and taring

PR/SR balances have separate keys for the zeroing function $\rightarrow 0 \leftarrow$ and taring function $\rightarrow T \leftarrow$ which enable you to determine correct tare and net weight values.

Zeroing with the $\rightarrow 0 \leftarrow$ key sets a new zero point, all weight values including the tare weight are measured with reference to this point.

The following holds after zeroing: tare weight = 0, net weight (= gross weight) = 0.

Use the zeroing key always when you start the weighing and wish to determine the tare weight first.

With taring using the $\rightarrow T \leftarrow$ key, the weight loaded on the balance since the last zeroing is set as a new tare weight. The previous tare weight is overwritten. The status display "Net" signals that after taring all displayed weight values are net values.



\rightarrow Set balance to zero with $\rightarrow 0 \leftarrow$ key.

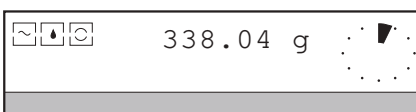

\rightarrow Place empty container on the balance.
The container weight is displayed.



\rightarrow Press $\rightarrow T \leftarrow$ key briefly to tare.

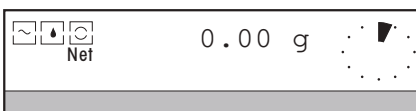

Zero and the "Net" symbol are displayed.



\rightarrow Add weighing sample to container.
The fill weight is displayed.

The tare weight remains stored until the next taring operation. All subsequent weighing results are net weights referred to the stored tare weight.

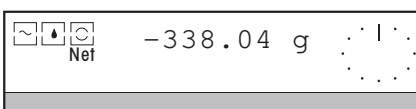

Clearing tare

\rightarrow Remove load from weighing pan.
The display shows the negative tare weight.

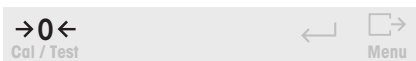

\rightarrow Press $\rightarrow 0 \leftarrow$ key briefly.

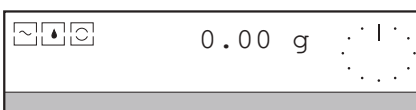

Zero is displayed. Tare weight and gross weight are cleared.

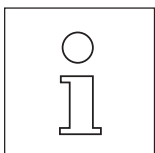

- If you zero the loaded balance, remove the load and then attempt to tare the balance with the $\rightarrow T \leftarrow$ key, the message "Press $\rightarrow 0 \leftarrow$ " appears. A negative tare value is inadmissible. In this case you must first rezero the balance with the $\rightarrow 0 \leftarrow$ key after removing the load.
- With certified balances, zeroing with load is allowed only up to $\pm 2\%$ of the weighing range of the balance. If the load after switching on the balance is greater, the message "Not allowed" appears if a zeroing attempt is made. Please first reduce the load.
- The parameter "PreTare" can be activated in the menu under "Weigh" (see section 6.2). This allows a known container weight to be entered and called up at any time.

3.4 Weighing with the analog display – METTLER DeltaTrac

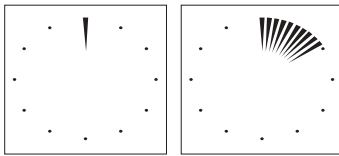

0 % in use

15 % in use

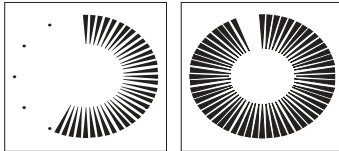

55 % in use

95 % in use

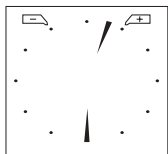

Weight within tolerance

METTLER **DeltaTrac** is a dynamic graphic display with 60 radial indicators showing the weighing range in use and that still available. You can thus see at a glance when the load on the balance approaches the maximum capacity.

In plus/minus statistics and formula weighing applications (sections 5.4 and 5.5), the **DeltaTrac** changes to a display with two pointers and two tolerance markers. This provides you with a quicker check on the relation of the weighing result to the target weight.

3.5 Weighing with DeltaRange balances with movable fine range



METTLER TOLEDO **DeltaRange** balances have a movable fine range with a 10 times more accurate readability. In this range, an additional decimal place always appears in the display.

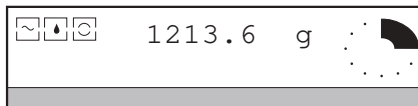

If the fine range is exceeded in the display, the balance display switches to the lower readability.



The balance operates in the fine range

- after switching on,
- after zero setting,
- after every taring operation.

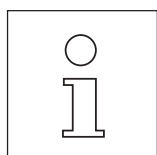
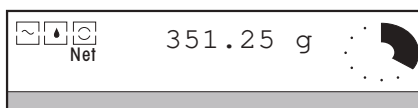
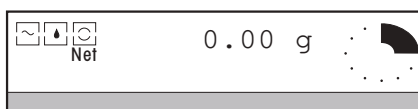

- Even if the balance operates in the fine range, you can switch between the higher and lower readability at any time by pressing the **1/10d** key (section 3.6).
- You can check the capacity of the fine range of your **DeltaRange** balance in section 7.2.

3.6 Quicker weighing with reduced readability

Certification regulations prevent you executing this function with certified balances.

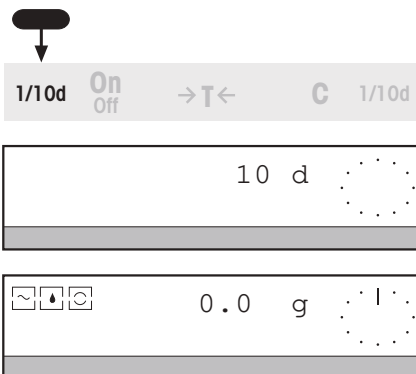

If, for once, you are not interested in the last decimal place, you can work appreciably faster with your balance.

→ Press and hold the **1/10d** key until "10 d" appears and the last decimal place in the display disappears.
Results can now be read quicker.

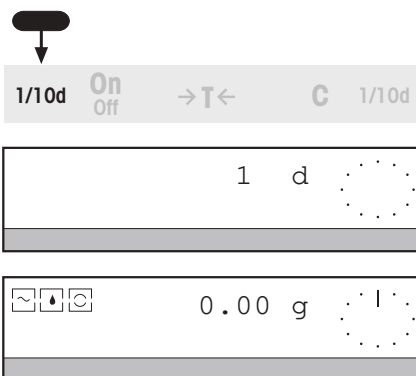

Return to normal readability

→ Press and hold the **1/10d** key again until "1 d" appears and all decimal places reappear in the display.

3.7 Recording / printing data

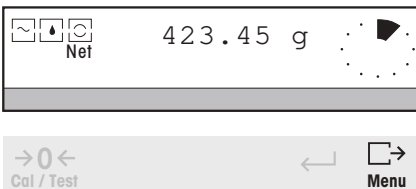

If a printer is attached, you can print out weighing results, identifications and other data.

The balance is set in the factory so that all stable weight values larger than 30 display increments are printed out automatically.

Printing data manually

→ Press  key briefly.

The results or settings in the top line of the display are printed out. An "N" in front of the weight value on the printout indicates that the value is a net value.

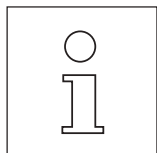

- Weight values are automatically printed out with the current tare value if the "PreTare" function is switched on in the menu. If "PT" is switched off, only the net weight is printed out.
- Under "SYSTEM -> Printout" (section 6.4) in the menu, you can activate a header printout and/or the printout and/or the printout of a sample identification, as well as manual transfer only of the results.
- Pressing the  key briefly also transfers the next stable weighing result via the LocalCAN universal interface (section 7.1).

3.8 Working with the SmartBar

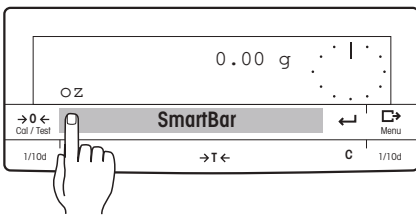

The **SmartBar** is the most important and most versatile key field of the PR/SR balance. Its configuration changes according to the weighing task thus allowing it to guide you through the operation by means of key words. The current configuration appears in the bottom line of the display directly above the **SmartBar**. Pressing the **SmartBar** directly below the key word activates the relevant function or calls up a selection.

Example *Weighing with 2 different weight units*

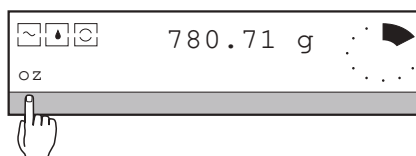
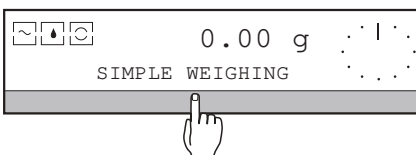
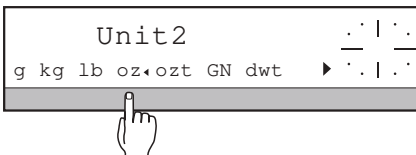
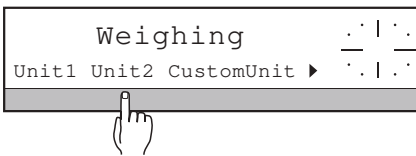
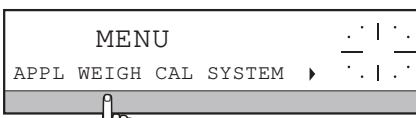
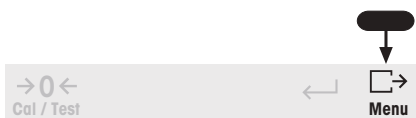

1. Setting in the menu

To allow the weighing mode to have 2 different weight units available, the 2nd unit has first to be defined in the menu. Proceed as follows:

→ Entry into menu: Press and hold  key until "MENU" appears in the display.

→ Press **SmartBar** below "WEIGH".

→ Press **SmartBar** below the "▶" character.
The display switches to the next selection under the same key word.

→ Press **SmartBar** below "Unit2".
The selection of the possible weight units for Unit2 appears.

→ Press **SmartBar** below the desired unit, e.g. below "oz".
"oz" will be marked by "♦".

→ End menu: Press and hold  key until "Stored" is displayed.

The balance is again in the weighing mode, the selected application – here "SIMPLE WEIGHING" – appears in the display.
By pressing any key the selected unit is available in the SmartBar line.

2. Switching the weight unit (weighing mode)

→ Press **SmartBar** below "oz".



The weight display and the selection in the bottom line of the display change. To clear the second unit, "Unit2" must be reset to "g" or must be set in the same way as "Unit1" in the menu.

3.9 Alphanumeric entry using the SmartBar

You can use the SmartBar to enter alphanumeric information, e.g. sample identification or a password.

Example *Alphanumeric entry of a sample identification (SampleID)*

1. Setting in the menu

To allow a sample identification to be entered during weighing, "SampleID" has first to be selected in the menu. Proceed as follows:

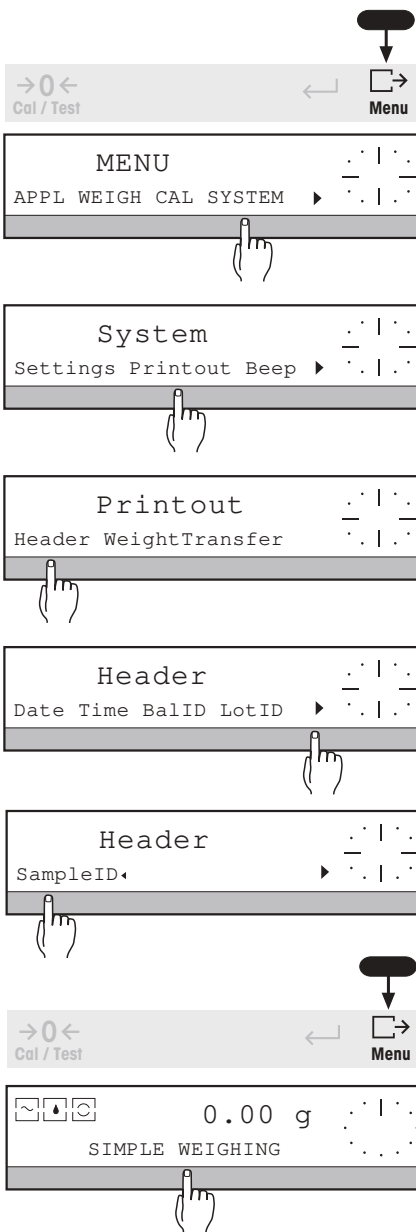

→ Entry into menu: Press and hold  key until "MENU" appears in the display.

→ Press **SmartBar** below "SYSTEM".

→ Press **SmartBar** below "Printout".

→ Press **SmartBar** below "Header".

→ Press **SmartBar** below the "▶" character.
The display switches to the next selection under the key word "Header".

→ Press **SmartBar** below "SampleID", "SampleID" is marked by "◀".

→ End menu: Press and hold  key until "Stored" is displayed.
The balance is again in the weighing mode, the selected application – here "SIMPLE WEIGHING" – appears in the display.
By pressing any key "SampleID" is available in the SmartBar line.

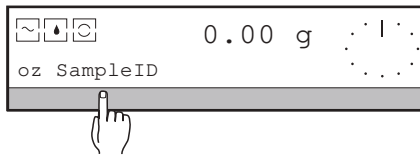

2. Entering sample identification (SampleID) alphanumerically (weighing mode)

→ Press **SmartBar** below "SampleID".

The following alphanumeric parameters can be entered:

- A - Z Uppercase letters 0-9 * ! Digits and special characters
- a - z Lowercase letters < Delete character

→ Make selection.

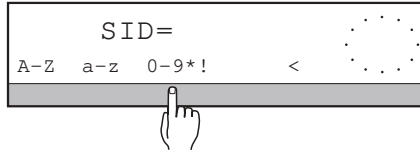

→ Enter a digit, e.g. "1".

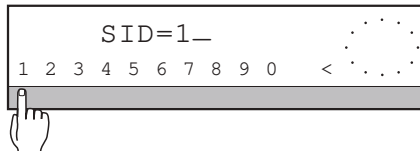

→ Press **↵** key briefly to confirm the entry and return to the selection level.

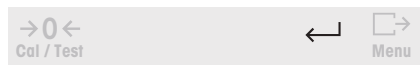

→ Make another selection, e.g. uppercase letters.

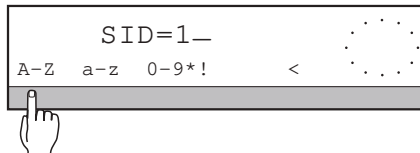

→ Enter an uppercase letter, e.g. "A".
A space is shown by "␣".

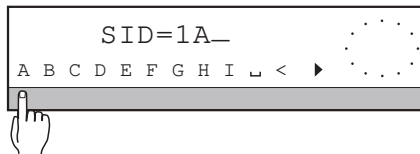

→ Press **↵** key briefly to confirm the entry and return to the selection level.

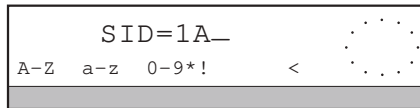

3. Concluding the entry

→ Press **↵** key again briefly.

The entire entry is confirmed, the balance is again in the weighing mode.

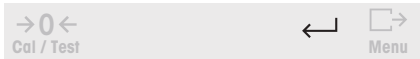
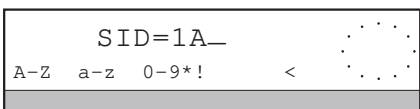

If a printer is attached, the sample identification appears on the printout together with the next weighing result.



4. Changing completed entry

If your identifications differ only slightly, there is no need to enter the complete identification every time, you can simply modify the existing identification.

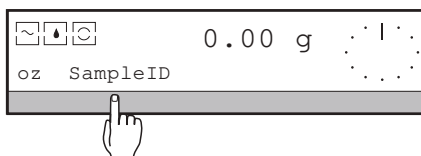

- Press "SampleID" in the weighing mode.
The sample identification last entered appears in the top line.

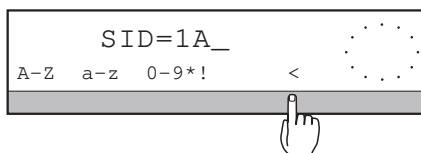

- Press the delete character "<".
The last character is deleted.

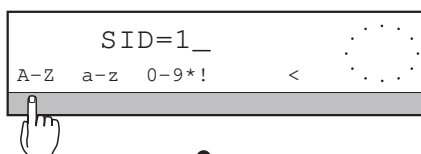

- Change identification as described under 2.



- Press the ↵ key again.
The entire entry is confirmed, the balance is now again in the weighing mode.

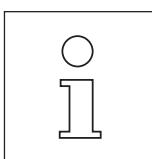

- The sample identification can comprise max. 20 characters.
- Before a further weighing result is printed out, you must change the last "SampleID", otherwise an input prompt with "SID=" automatically follows. This prevents 2 results with the same name from being printed out.
- If you close the entry with the  key, the sample identification is immediately printed out.
- When all characters are deleted and you press the delete character again, the old identification reappears.

3.10 Entry with bar-code reader or external keyboard

With all input prompts in the weighing mode, you can also effect the entry using a bar-code reader or an external keyboard with RS232 interface.

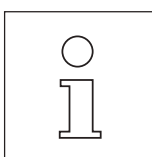

- You can attach the METTLER TOLEDO LC-BCR bar-code reader directly to your PR/SR balance.
- You can attach an external keyboard using the METTLER TOLEDO LC-RS cable (section 7.3).
- If the sample identification is selected in the menu, each entry via the bar-code reader is automatically considered as a "SampleID". You can enter other values, e.g. "LotID" via the bar-code reader only when the appropriate input prompt ("LID=") is shown in the display.

4 Extended basic functions

Your PR/SR balance has extended basic functions such as header printout, sample and series identification, tare preset and operation with various weight units.

To ensure these additional functions are available in the weighing mode, you first have to activate them in the menu. You can select the extended basic functions for every application.

4.1 Header printout – "Header"

The printout of the weighing results can be provided with a header.

Requirement

In the menu under "SYSTEM -> Printout > Header" at least one of the parameters "Date", "Time", "BalID" or "LotID" must be selected (see section 6.4.2). In simple weighing and piece counting, "Header" then appears in the bottom line of the display. With the other applications, the header is automatically printed out at the start of the weighing series.

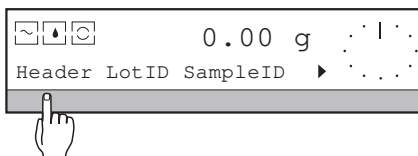

```

17.06.95      15:58:37
Type:         PR5002DR
SNR:         1114051374
Bal:         "Your entry"
Lot:         Series 1
  
```

Initiating a header printout (weighing mode)

→ In weighing operation, press SmartBar below "Header".
The defined header will be printed out.

- The date is printed out at the top left when "Date" is activated in the menu.
- The time is printed out at the top right when "Time" is activated in the menu.
- Balance type (Type), serial number (SNR) and balance identification (Bal) of the user are printed out when "BalID" is activated in the menu.
- The series identification is printed out when "LotID" is activated in the menu.
- The header printout can be selected for every application.

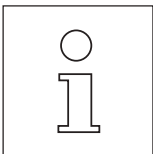

You can not change the serial number of the balance (SNR). It is printed on the model plate on the balance housing. On the other hand, you have a free selection regarding the balance identification "BalID" (section 6.4.6).

4.2 Series identification – " LotID "

Before the start of a weighing series, an alphanumeric series identification can be entered (section 3.9 and 3.10). This identification appears on the printout in the header.

Requirement

The parameter "LotID" for the series identification must be activated in the menu under "SYSTEM -> Printout -> Header". In weighing operations, "LotID" then appears in the bottom line of the display.



Entering series identification

→ Press SmartBar below "LotID".

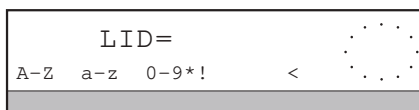

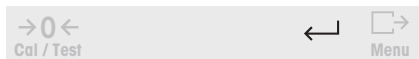

→ Enter series identification alphanumerically, see section 3.9. The series identification can comprise max. 20 characters.

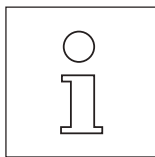

→ Close entry with ←.

The weighing series can now be started. When a header is printed out, the series identification last entered appears.



- You can select the series identification for every application.
- Corrections to the entry are possible, see example 2 in section 3.9.
- If you close the entry with the  key, the series identification (alone) is printed out immediately.
- The series identification can also be read in using a bar-code reader, e.g. LC-BRC or entered using a keyboard attached via the LC-RS cable (Optional equipment, section 7.3).

4.3 Sample identification – " SampleID "

An alphanumeric sample identification can be entered for every weighing. This identification appears on the printout with the next weighing result. Section 3.9 illustrates the procedure.

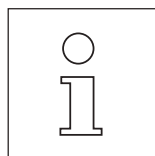

- You can select the sample identification for every application.
- Corrections to the entry are possible, see section 3.9.
- The sample identification can also be read in using a bar-code reader, e.g. LC-BRC or entered using a keyboard attached via the LC-RS cable (Optional equipment, section 7.3).

4.4 Entering a fixed tare weight – " PreTare "

The "PreTare" function allows you to enter a known tare weight numerically or by weighing and call up or clear the current value. The PreTare value is then automatically subtracted from the current weight and the net weight appears in the display.

Requirement

The "PreTare" function must be activated in the menu under "WEIGH -> Tare" (section 6.2). In weighing operations, "PreTare" then appears in the bottom line of the display.

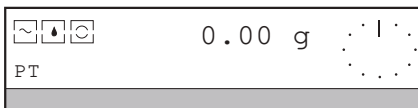

Entering weighed tare value

- Remove any load from the balance and zero with the →0← key. The following applies after zeroing: Tare weight = 0, net weight = 0.

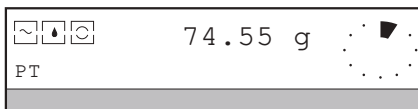

- Place tare container on the balance. The container weight is displayed.



- Press →T← key.



The current weight is transferred as a fixed tare preset to the PreTare memory, the top line shows zero. The "Net" symbol signals that all subsequent values are displayed as net values.

Entering a known tare weight numerically or calling up the current value as a tare preset

- Press SmartBar under "PT".

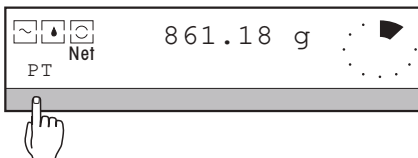

The top line shows the current tare weight. "T=..." symbolizes a weighed value (determined with the →T← key). "PT=..." symbolizes a value that has been entered manually (PreTare).

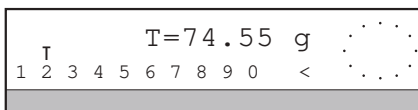

- Enter numeric value of known tare weight and confirm with ↵, or confirm displayed value directly with the ↵ key.

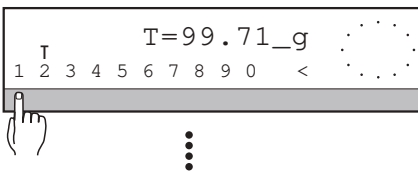

If the container whose weight has been entered was on the weighing pan with the sample, the net weight of the sample and the "Net" symbol are automatically displayed following the entry.

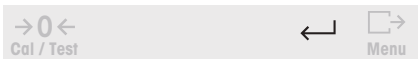

If the display was zero, the inputted value appears in the top line with a negative sign and the "Net" symbol.

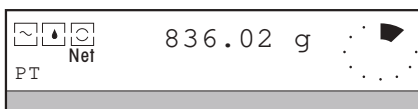

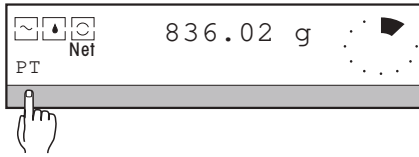

Clearing the PreTare value

→ Press SmartBar under "PT".

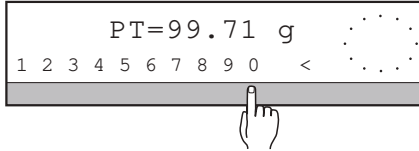

→ Enter "0" (zero).
This clears the PreTare value last entered.

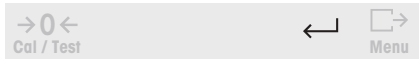

→ Confirm entry with the ← key.

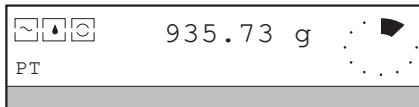

The value of the PreTare memory is now set to zero, i.e. cleared, the display returns to the display of the total weight.

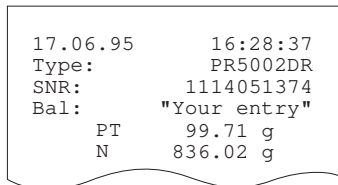

On the printout, "PT" symbolizes the manually entered value for the PreTare. "T" symbolizes the weighed tare value (determined with the →T← key).

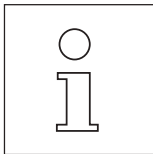

- The tare value is also cleared on zero setting with the →0← key.
- Weight values are automatically printed out with the current tare value when the PreTare function is switched on in the menu. When the "PT" function is switched off, only the net weight is printed out.
- The PreTare value can also be read in using a bar-code reader, e.g. LC-BCR or entered via a keyboard attached via the LC-RS cable (Optional equipment, section 7.3).
- You can use the PreTare function in every weighing application.

4.5 Switching units – " Unit2 ", " CustomUnit "

In weighing operations, the PR/SR balances offer you the possibility of using not only weight unit 1 "Unit 1", which appears automatically after the balance has been switched on, but also a second weight unit "Unit 2" and a further unit "CustomUnit". You can freely define this last unit, e.g. for automatic conversion of the weight as a function of a length (g/m).

Requirement

In the menu under "WEIGH -> Unit2" a unit different to that under "Unit1" and/or "WEIGH -> CustomUnit" must be selected. The selected weight unit and/or the name for the user-defined unit "CustomUnit" then appears in the bottom line of the display (see section 6.2).

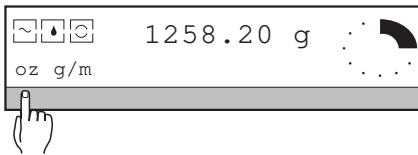

→ Press SmartBar below the displayed unit, the weight display and the selection in the bottom line of the display change.

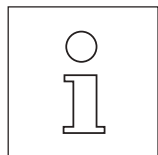
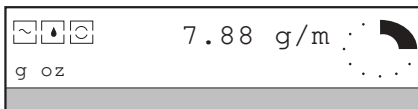
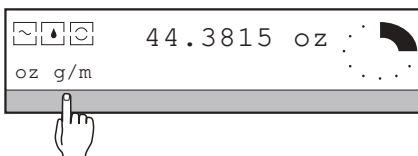

- A result in a "CustomUnit" is displayed and printed out with the user-defined name or with [C].
- With certified balance models, you may not be able to select certain units owing to restrictions imposed under the weights and measures act.

5 Applications

5.1 Dynamic weighing with statistics – "Dynamic "

In dynamic weighing you obtain stable weighing results even if the weighing sample or the balance itself moves, e.g. in animal weighing or if the balance is wobbling.

After start of the weighing, around ten weighing results per second are determined until a preset weighing time has elapsed. The balance then determines the mean value and displays this as the weighing result "dw".

You can also statistically evaluate your dynamic weighings.

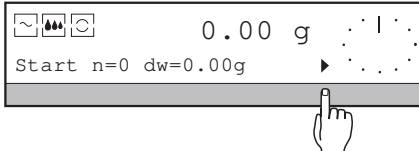

In dynamic weighing you have the following functions and information available in the bottom line of the display:

- "Start" for starting the weighing manually
- "n=..." item counter with number of weighings performed
- "dw=..." result of the last dynamic weighing or one of the selections specified under "Results"
- "Results" selection of one of the 5 results that should always be shown in the bottom line during dynamic weighing
- "Clear" sets item counter and all results to zero, ends the weighing series
- "WghTime" duration of the dynamic weighing, selectable between 1 s and 20 s extended basic functions (see section 4) if activated in the menu

Requirement

For dynamic weighing, "Dynamic" must be selected under "APPL" in the menu (section 6.1). Further, you can use the menu to select whether dynamic weighing should start manually or automatically when a load is placed on the balance ("Start -> Manual" or "Start -> Auto") and what minimum weight ("MinWeight") has to be exceeded for the weighing to start automatically.

If the application is active, "DYNAMIC WEIGHING" and the  symbol appear in the display after return to the weighing mode.

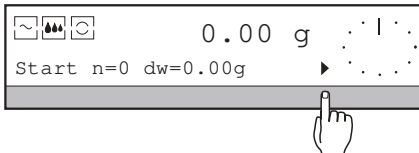

1. Setting duration of weighing time

The factory setting corresponds to a duration of 3 seconds. If a different setting of the weighing time is required, proceed as follows:

→ Press SmartBar under "►" to obtain further selections.

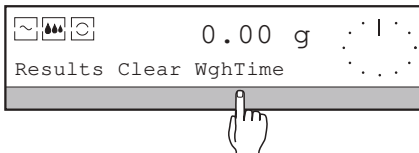

→ Press SmartBar under "WghTime".

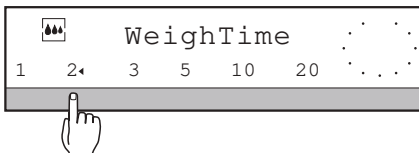

→ Select desired duration, e.g. 2 seconds.

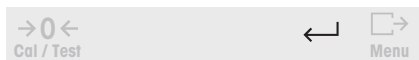

→ Press ← to confirm selection.

2. Weighing

Depending on the setting in the menu (section 6.1.2)

- the weighing must be started either **manually** (factory setting),
- or **automatically** when a load is placed on the balance. The first weighing must be started manually in this case.

*Dynamic weighing with **manual** start*

→ Place empty container on balance and tare.

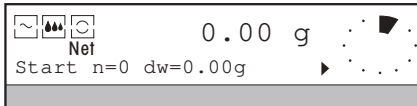

→ Add weighing sample to container.

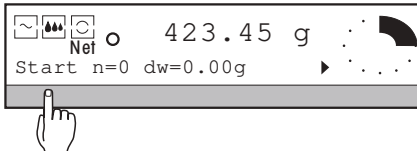

→ Press SmartBar under "Start", the weighing then starts immediately.

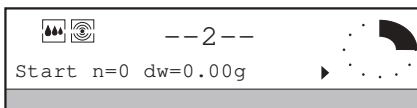

During the weighing, a "countdown" runs in the display and the  symbol flashes.

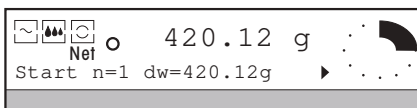
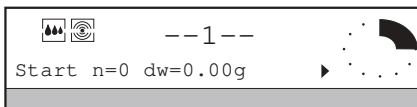

→ After elapse of the weighing time, the weighing result appears in the bottom line of the display as "dw=...". The item counter "n=..." is incremented by one. "dw" and "n" remain in the display until the values are overwritten by a new result or cleared with "Clear".

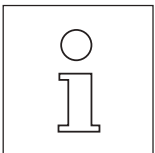

- You can terminate the current weighing at any time with the **C** key or restart it with "Start". If the balance is overloaded during the weighing, the weighing is automatically aborted and the message "Abort" outputted.
- Depending on the selection under "Results", you can also display values other than "dw" in the bottom line.
- If you have activated the sample identification in the menu (section 4.3), you are prompted for its entry with "SID=..." before every start.
- You can also initiate the weighing using the LC-FS foot switch (Optional equipment, section 7.3). The foot switch must be set to switch position 4  for this. You thus have both hands free and need not touch the balance.

*Dynamic weighing with **automatic start*****Requirement**

The setting "Auto" must be activated in the menu under "APPL - > Dynamic -> Start" (section 6.1.2).

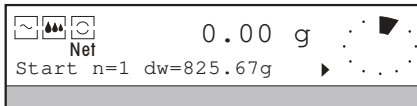
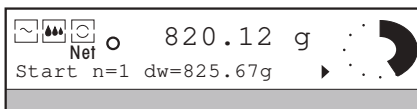
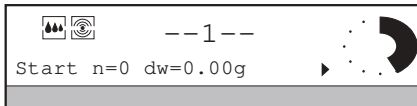
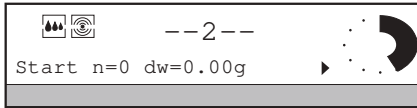
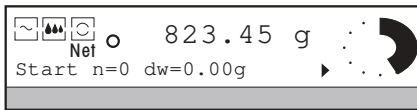

→ Place empty container on balance and tare.

→ Add weighing sample to the container and start the first weighing manually. Each subsequent weighing starts automatically as soon as the loaded weight exceeds the minimum load specified under "MinWeight" in the menu and the start conditions are met (see section 6.1).

During the weighing, a "countdown" runs in the display and the  symbol flashes.

→ After elapse of the weighing time, the weighing result appears in the bottom line of the display as "dw=...". The item counter "n=..." is incremented by one. "dw" and "n" remain in the display until the values are overwritten by a new result or cleared with "Clear".

→ Remove weighing sample from container.

If desired, tare the balance with the →T← key.

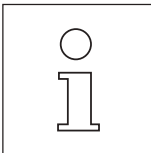

- The next weighing then starts automatically when the weight display shows a value below that specified under "MinWeight" in the menu following removal of the sample and the new, loaded weight exceeds this value.
- You can also determine lower values manually with "Start".
- You can terminate the current weighing with the **C** key or restart it with "Start". If the balance is overloaded during the weighing, the weighing is automatically aborted and the message "Abort" outputted.
- Depending on the selection under "Results", you can also display values other than "dw" in the bottom line.
- If you have activated the sample identification in the menu (section 4.3), you are prompted for entry with "SID=..." before every start.

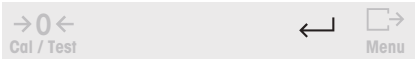
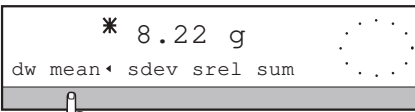
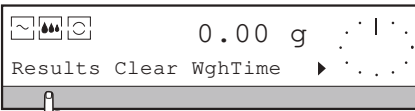
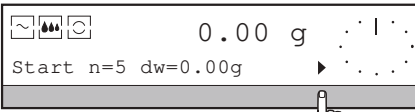

3. Display of the calculated results

The calculated results of the weighing series can be called up in succession and one of them always displayed during weighing.

→ Press SmartBar under "►".

→ Press SmartBar under "Results".

The bottom line of the display shows the selection of the following results whose value appears in the top line marked by "*":

- "dw" Result of the last dynamic weighing (factory setting)
During weighing, "dw=..." appears in the bottom line of the display.
- "mean" Mean value
During weighing, "x=..." appears in the bottom line of the display
- "sdev" Standard deviation
During weighing, "s=..." appears in the bottom line of the display
- "srel" Relative standard deviation (standard deviation in % of the calculated mean value)
During weighing, "srel=..." appears in the bottom line of the display.
- "sum" Sum
During weighing, "Σ=..." appears in the bottom line of the display.

→ Press SmartBar under the desired result.

The selected result is marked by "*" and its value displayed in the top line.

→ Confirm selection with ←.

From now on the selected result will always be shown in the bottom line during weighing.

4. Weighing series with preselected number of weighings

If the number of weighings is entered in advance, when this number is reached and the balance unloaded the final results are printed out. At the same time, the series is automatically ended and the results are deleted.

Preselecting number of items

→ Press SmartBar under "n=...". "Max n=..." appears in the top line of the display.

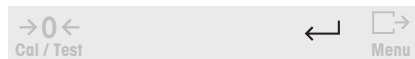
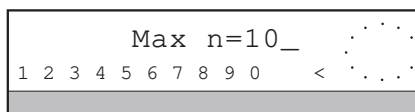
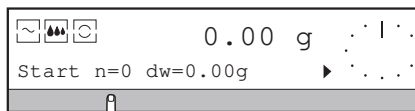

→ Enter size of series.

Possible values: 1 ... 999, with "Max n=0" the number of items is not specified (factory setting). If the entry lies outside the admissible range, the message "Illegal value" appears.

→ Confirm entry with ←.

If the entry is confirmed with the  key, the preset number is immediately printed out.

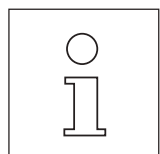

If you attempt to incorporate more weighings in the calculation than are specified, the message "n=Max n" appears in the display. To transfer additional weight values for the calculation, you must first increase "Max n" or set it to zero.

5. Closing weighing series

→ Press SmartBar under "►".

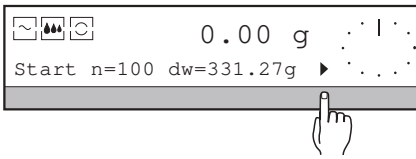

→ Press SmartBar under "Clear".

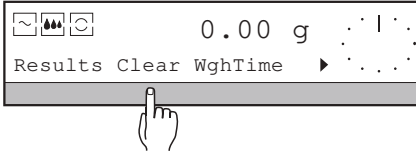

The series is ended. If not already done and if a printer is attached, the current status of the item counter and the results will be recorded (see section "Printout"). The item counter and all results are then set to zero.

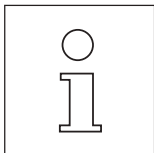
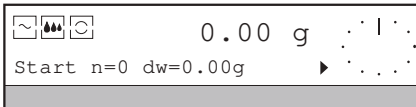

- The dynamic weighing series is automatically closed if you are working with a preselected number of weighings "Max n" and unload the balance or if you switch the balance off.
- To perform settings in the menu, you must first close the weighing series.

```

--- DYNAMIC WEIGHING ---
17.06.95          10:36:04
Type:            PR8002DR
SNR:            1114051374
Bal:            Your entry

Weigh Time:      3 s
Max n:           5
1 *             50.42 g
2 *             66.47 g
3 *             54.20 g

n                5
x                54.772 s
s                6.702 g
s rel           12.24 %
sum             273.86 g
min             50.42 g
max             66.47 g
min-max         16.05 g
----- END -----
    
```



Printout

The following appears on the printout of a dynamic weighing series:

- Set application "DYNAMIC WEIGHING" and set weighing time. These data are automatically printed out in the first weighing or can be printed out with the  key after setting the weighing time.
- Header lines, if set in the menu.
- Sample size "Max n", if preset.
- Individual result of each weighing.
- Results of the weighing series.

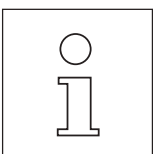
If "Manual" is set in the menu under "SYSTEM -> Printout -> Weight", only the final results are printed out.



- You can also activate the extended basic functions series and sample identification, PreTare and unit switching in dynamic weighing (see section 4).
- When the balance is switched off, the results are printed out and the weighing series is closed.
- To perform settings in the menu, you must first close the weighing series with "Clear".
- When you press  key during the "countdown", the next dynamic or stable weighing result is transferred as described under  in section 7.1.

5.2 Piece counting – "Count"

With the piece counting application you count parts of approximately equal weight. The piece weight needed for counting is calculated by the balance after you have loaded a known number of pieces and set this number equal to the reference.

With the reference optimization function "Opt", the piece weight can be recalculated more accurately after increasing the piece number.

If the piece weight is known, you can also enter its numeric value directly.

In piece counting you have the following functions and information available in the bottom line of the display:

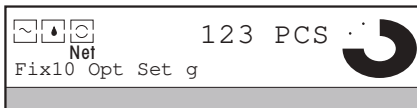

- "Fix n" for calculation of the piece weight from n pieces, n is selectable
- "Opt" for improving the counting accuracy by recalculation of the piece weight
- "Set" for setting a reference number or for entry/inquiry of the piece weight
- "Unit1" for switching between piece number and weight if you have already calculated a reference

extended basic functions (see section 4) if activated in the menu.

Requirement

For piece counting, "Count" must be selected under "APPL" in the menu (see section 6.1.). If the application is active, "PIECE COUNTING" appears in the display after return to the weighing mode.

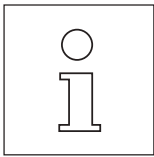

The balance can calculate the piece weight only if it is on average at least one display increment. Otherwise, the message "Illegal value" appears.

1. Reference calculation – determination of the piece weight

Depending on the weighing task, the piece weight can be calculated in one of three different ways:

Reference calculation with preset reference number

→ Place container in center of weighing pan and tare.



→ Place number of pieces specified under "Fix..." on the balance or remove from the full, tared container.

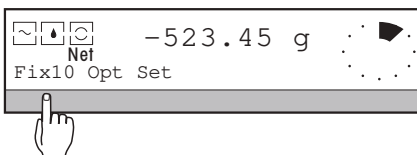

→ Press SmartBar under "Fix...".

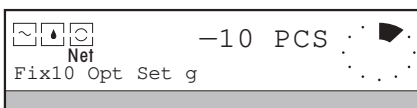

The balance calculates the piece weight, the current piece number appears in the display designated by "PCS". A negative sign indicates that the pieces have not been placed on the weighing pan, but removed from the container.

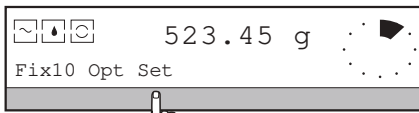

Reference calculation with different reference number

- Place known number of pieces on the balance or remove from a full container.
- Press SmartBar under "Set" (set reference).

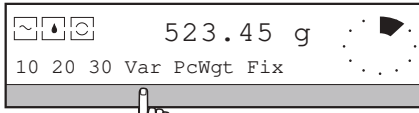

- Press SmartBar under one of the displayed reference numbers if the number of pieces on the balance corresponds to one of these numbers or
- Press SmartBar under "Var" (variable) and key in numeric value of the desired reference number.

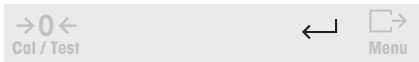
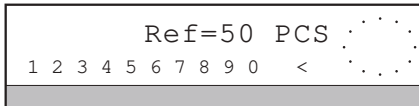

- Press ← to confirm selection or entry.

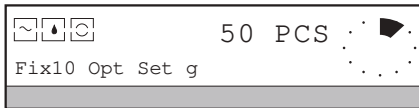

The current piece number appears in the top line of the display.

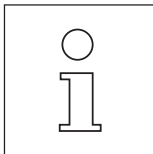

- Select a relatively high reference number if the weights of the parts you wish to count show a fairly large scatter. The higher the reference number, the better the counting accuracy.
- You can also initiate the "Fix n" function with the LC-FS foot switch (Optional equipment, section 7.3). The foot switch must be set to switch position 4  for this. You thus have both hands free and need not touch the balance.

Enter known piece weight – call up current piece weight



- Press SmartBar under "Set" (set reference).

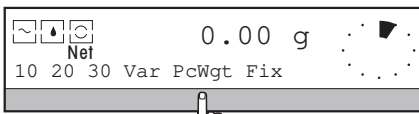

- Press SmartBar under "PcWgt" (piece weight).
The display shows the current piece weight in weight unit 1.

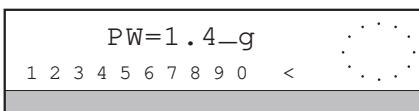

- Key in numeric value of known piece weight in weight unit 1.
Possible values for "PW": 0...max. load. An entry outside this admissible range leads to the message "Illegal value".

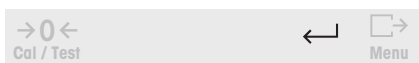

- Press ← to confirm entry, the display shows the number of pieces on the balance.

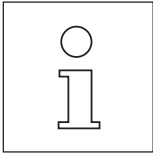

- If you have called up the current piece weight simply for information purposes, you can print it out by pressing or quit the entry without changing it by pressing \leftarrow or **C**.
- You can enter any piece weight numerically that is lower than the admissible maximum capacity of the balance.
- If zero is entered as a piece weight, the reference is cleared.
- Note that the counting accuracy depends on the piece weight and the readability of the balance.
- The piece weight can also be read in using a bar-code reader, e.g. LC-BCR or entered using a keyboard attached via the LC-RS cable (Optional equipment, section 7.3).

2. Reference optimization

To improve the counting accuracy, the piece weight calculated by the balance can be calculated more accurately by using a larger piece number with the reference optimization function "Opt".

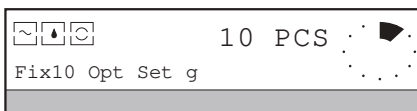

→ Calculate reference as described above, e.g. with Fix 10.

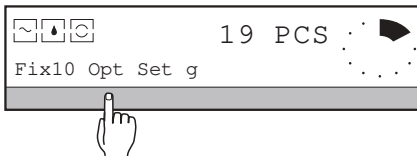

→ Load additional parts until around double the previous piece number is shown, e.g. 19.

→ Press SmartBar under "Opt" (reference optimization).

The balance recalculates the reference weight, now using the larger reference number.

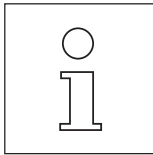

- If you use the "RefOpt" function and the piece number has been more than doubled or if you have entered the piece weight numerically, the error message "RefOpt - Err" appears; if no reference has been calculated, "No reference" appears.
In the first case, first decrease the piece number.
- You can repeat the reference optimization to improve the accuracy still further.

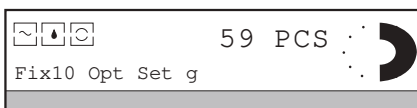

3. Piece counting

→ Place more parts on the pan, the piece number is displayed.

If you have determined the piece number by removal from a container, the "PreTare" function (section 4.4) can be used to enter the known tare weight. The number of pieces remaining in the container is then displayed directly.

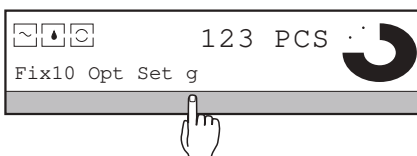

4. Switching between piece number and weight

→ Press SmartBar under the displayed weight unit, the top line changes to the weight display, the bottom line shows "PCS" for selection.

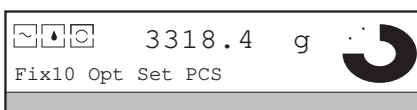

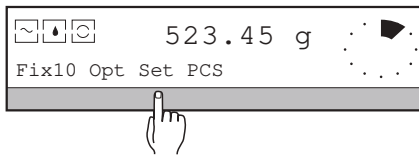

Changing selection "Fix..."

→ Press SmartBar under "Set" (set reference).

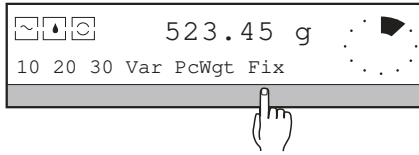

→ Press SmartBar under "Fix" and enter numeric value of the desired reference number.

Possible values for "Fix": 1 ... 1000. An entry outside the admissible range leads to the message "Illegal value".

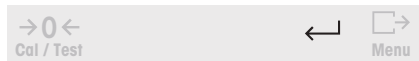
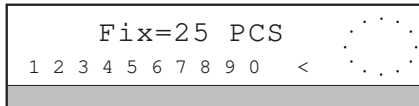

→ Confirm entry with ←.

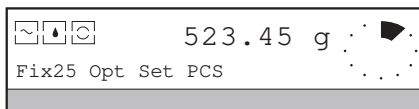

The modified selection "Fix..." appears in the bottom line of the display.

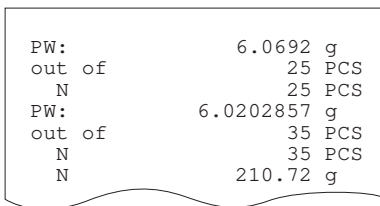

Printout

The following appears on the printout with the first result:

- The piece weight calculated by the balance and the reference number used (each time the balance calculates the piece weight).
- Further results in pieces.
- Results in the weight unit if a switch has been made.

If the parameter "Manual" is set in the menu under "SYSTEM -> Printout -> WeightTransfer", results can be printed with .

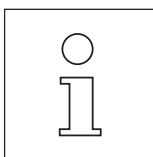

- You can also activate the extended basic functions header printout, series and sample identification, tare preset and unit switching for piece counting, see section 4.
- With the "piece counting" application, you can use the balance at any time for weight determination if you switch from "PCS" to the weight unit.

5.3 Totalization – "Tot"

If you wish to sum the weight values of your samples to a total weight, this is the right application for you.

Use the menu (section 6.1) to select whether you should remove each sample from the weighing pan after weighing (parameter "Mode" to "Single") or whether you should place all the samples in succession on the pan without removing any ("Mode" to "Additive"). In addition, you have the possibility to transfer the weight value for calculation of the total at a keystroke (parameter "WeightEntry" to "Manual") or automatically ("WeightEntry" to "Auto").

You can thus optimally match the application to meet your needs.



In totalization you have the following functions and information available in the bottom line of the display:

"M+"	transfers the weighed value to the totalization memory
"n=..."	item counter with number of the totalized weight values, also used to preset the number of items
"Σ=..."	current total of the weight values, prints out the results
"M-"	removes the last transferred value from the totalization memory (correction key)
"Clear"	sets the item counter and totalization memory to zero, ends the weighing series

extended basic functions (see section 4) if activated in the menu

Requirement

The application "Tot" must be selected under "APPL" in the menu and the weighing procedure ("Mode") as well as the type of weight transfer ("WeightEntry") specified (see section 6.1).

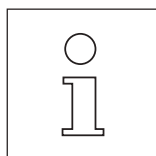

- For the weight transfer, the balance must be able to stabilize itself and the load change must attain the minimum value, which you can enter under this application in the menu by "WeightEntry -> MinChange". If the weight change is too small, the message "MinChng - Err" appears.
- You can use "M+" to transfer negative weight values which are displayed when the samples are removed from a full, tared container or weight values less than 30 display increments.
- If you are working with the extended basic function "Sample identification" (section 4.3), you are automatically prompted for its entry with "SID=..." before every weight transfer.

1. Totalization

Depending on the setting of "Mode" and "WeightEntry" in the menu under the application "Tot" (section 6.1.4), totalization is performed in one of 4 ways:

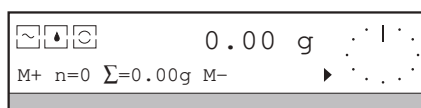
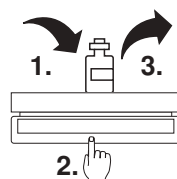

→ Set balance to zero or tare.

→ Place sample on the weighing pan.

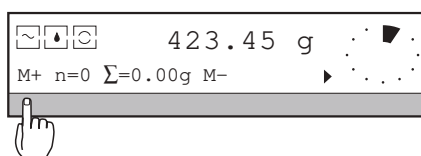

→ Press SmartBar under "M+".

The next stable weighing result, visible in the top line, is incorporated in the total.

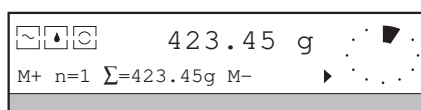

The item counter "n=..." is incremented and the updated total shown in the bottom line of the display under "Σ=...".

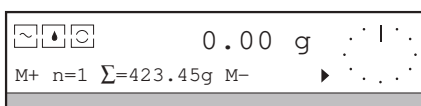

→ Remove sample from weighing pan and load next sample, press SmartBar under "M+" etc.

You can also initiate the weight transfer using the LC-FS foot switch (Optional accessories, section 7.3). The foot switch must be set to switch position 4  for this. You thus have both hands free and need not touch the balance.



Totalization of single weighings with automatic weight transfer

(Mode = Single, WeightEntry = Auto)

The first weight must be transferred manually.

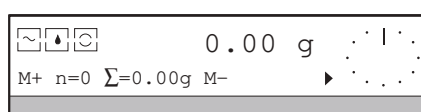

→ Set balance to zero or tare.

→ Place sample on the weighing pan.

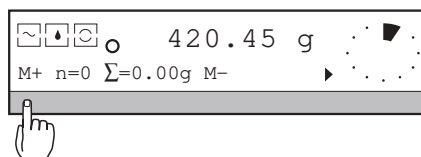

→ Press SmartBar under "M+".

The first stable weight value (n=1) is transferred.

The item counter "n=..." is incremented and the updated total shown in the bottom line of the display under "Σ=...".

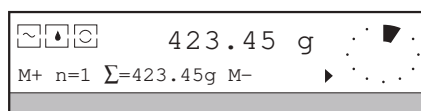

→ Unload balance by at least the value of "MinChange" (set in menu) and place another sample on the pan.



The next stable weighing result, shown in the top line, is automatically transferred to the total.

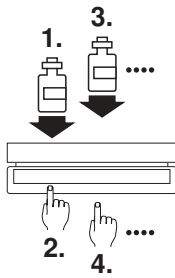

Totalization of weight values without sample removal from pan and with manual weight transfer

(Mode = Additive, WeightEntry = Manual)

- Place container on center of weighing pan and tare.
- Add sample to container.

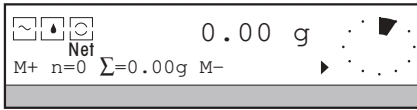

- Press SmartBar under "M+".

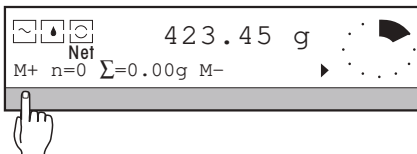

The next stable weighing result, visible in the top line, is incorporated in the total and the display automatically set to zero. The item counter "n=..." is incremented and the updated total shown in the bottom line of the display under "Σ=...".

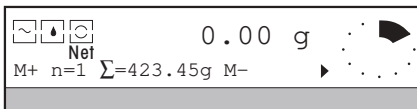

- Add next sample to container, press SmartBar under "M+" etc.

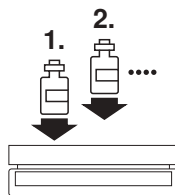
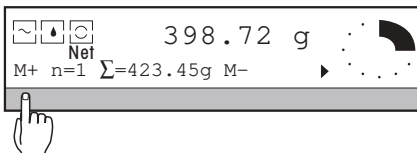

Totalization of the weight values without sample removal from pan and with automatic weight transfer

(Mode = Additive, WeightEntry = Auto)

The first weight must be transferred manually.

- Place container on center of weighing pan and tare.
- Add sample to container.

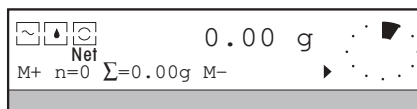

- Wait until the stability detector (o) fades.
- Press SmartBar under "M+".

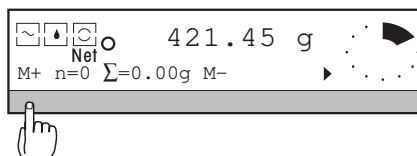

The first stable weight value (n=1) is transferred. The item counter "n=..." is incremented and the updated total shown in the bottom line of the display under "Σ=...".

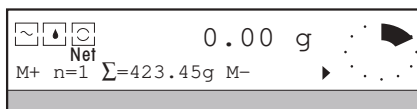

- Add next sample, wait for stability etc. The next stable weighing result, shown in the top line, is automatically transferred to the total and the display set to zero.

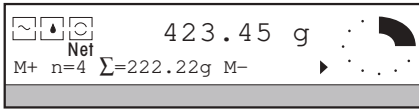
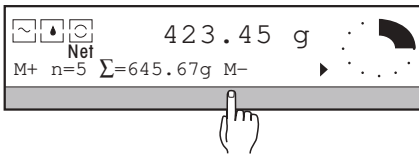

2. Deleting weight value from the totalization memory

If the result has been added to the total by accident, it can be deleted.

- Remove wrong sample from balance.
- Press SmartBar under "M-". The result last added is deleted and the item counter decremented by 1. The total shown under "Σ=..." is updated.

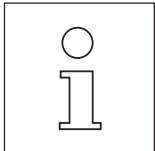

Deleted results are printed out with a negative item number and shifted to the left.

3. Totalizing with a preset number of samples

If a preset number of samples has been entered, the balance automatically prints out the final results when this number of items has been reached and the balance unloaded. At the same time, the series is ended automatically and the results are cleared.

To enter the number of items:

- Press SmartBar under "n=...", "Max n=..." appears in the top line of the display.

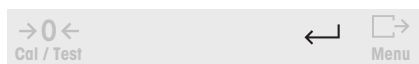
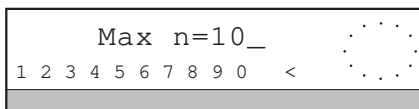
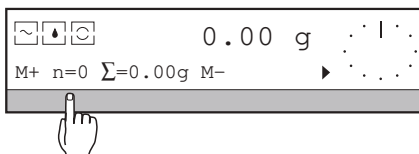

- Enter numeric value of series size.
Possible values: 1 ... 999, with Max n=0 the number of items is not specified (factory setting). An entry outside the admissible range leads to the message "Illegal value".

- Confirm entry with ↵.

When confirming the entry with the  key, the preset number is printed out immediately.

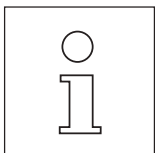

If you attempt to totalize more weight values than are specified, the message "n=Max n" appears in the display. To transfer more weight values, you must first increase "Max n" or set it to zero.

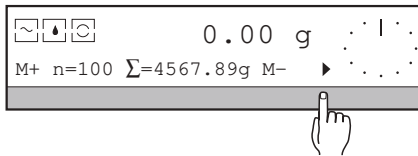

4. Ending the totalization

→ Press SmartBar under "►".

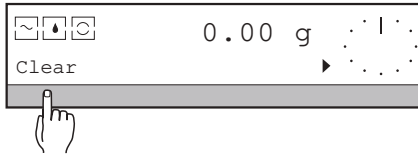

→ Press SmartBar under "Clear".



The totalization is finished. If a printer is attached, the current status of the item counter and the totalization memory will be printed out if not already done. Finally, the item counter and totalization memory are set to zero.

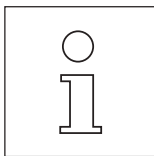

- The totalization is concluded automatically when you work with a preset number of samples "Max n" and unload the balance or if you switch off the balance.
- So that you can undertake settings in the menu, you must first close the weighing series.

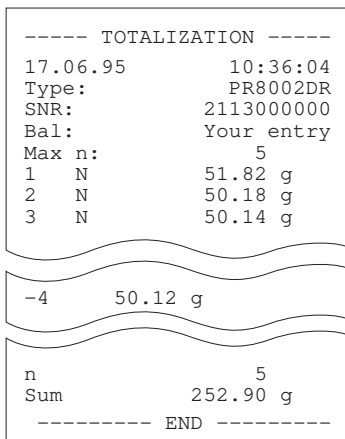

Printout

The printout of a sample series includes the following:

- Name of the application "TOTALIZATION".
 - Header printout, if set in the menu.
 - Number of items "Max n", if preset.
 - Individual weights of every sample.
 - Number of weight values actually transferred (number of items "n").
 - Total of the weight values "sum".
- Number of items and sum are printed out when the SmartBar is pressed under "Σ=..." or if the totalization has been ended with "Clear" or automatically.

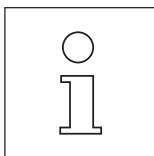

- If you have set the parameter "WeightTransfer" to "Manual" under "SYSTEM -> PrintOut" in the menu, you can print out the weight values with  as long as they are in the top line of the display.
- You can also activate the extended basic functions series and sample identification, tare preset and unit switching for the "totalization" application (section 4).

5.4 Plus/minus statistics – "+/-Stats"

The plus/minus statistics application offers you two basic possibilities:

- You can follow and document the most important statistical data on the weights of your parts or weighings. With this application, the METTLER DeltaTrac shows the weighing range in use and that remaining.
- You can check parts or added quantities by weight or even perform several weighings of equally heavy samples. With this application, a nominal weight must be entered. The position of the sample weight with regard to the tolerances can be rapidly determined using the METTLER DeltaTrac. Further, results can be shown as absolute values or in percent relative to the nominal weight.

As with other applications, you select in the menu whether you remove the individual samples from the weighing pan after the weighing (parameter "Mode" to "Single") or place all on the pan in succession without unloading the balance ("Mode" to "Additive"). You also have the possibility to use the weight value for further calculations at a keystroke (parameter "WeightEntry" to "Manual") or automatically ("WeightEntry" to "Auto").

With plus/minus statistics you have the following functions and information available in the bottom line of the display:

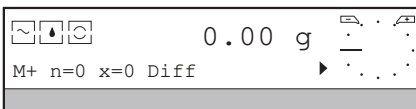

"M+"	transfers the weighed value for further calculation
"n=..."	item counter showing number of weighings performed, also used to preset the number of items
"x=..."	Display of one of the values selected under "Results" "<T-", ">T+", "mean", "sdev", "srel", "min", "max", and "sum"
"Diff" / "Abs"	shows the difference to the target weight or the absolute value as a weighing result
"SetRef"	entry of the nominal weight "Nom" and the tolerance limits "-Tol" and "+Tol" or set reference weight to 100% ("Set100%").
"Results"	Selection and inquiry of one of the 8 results "<T-", ">T+", "mean", "sdev", "srel", "min", "max", and "sum" that should always be shown in the bottom line during weighing.
"Clear"	sets the item counter and totalization memory to zero, ends the weighing series
	extended basic functions (see section 4) if activated in the menu
"Unit1"	for switching between display in % or weight unit

Requirement

The application "+/-Stat" must be selected under "APPL" in the menu and the weighing procedure ("Mode") as well as the type of weight transfer ("WeightEntry") specified (see section 6.1).

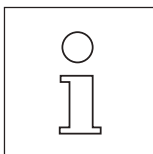

- For calculations, the balance accepts only stable weight values which attain the minimum load change you have entered in the menu under "WeightEntry" -> "MinChange". Otherwise, the message "MinChng - Err" appears in the display.
- If you work with the extended basic function "Sample identification" (section 4.3), you will automatically be prompted for entry before every weight transfer with "SID=...".
- Weight values less than 30 display increments can only be transferred manually with "M+".

1. Setting reference values

This entry is necessary only in the weight check with respect to a target value or in the weighing of equal amounts of samples using the METTLER DeltaTrac.

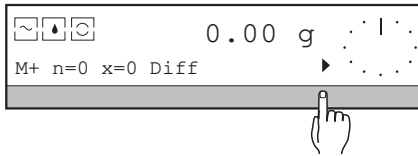

→ Press SmartBar under "►".

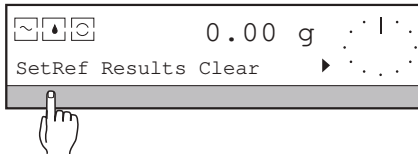

→ Press SmartBar under "SetRef".

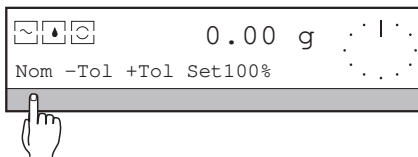

a) Setting known nominal weight using numeric keys

→ Press SmartBar under "Nom", "Nom=..." is displayed in the top line.

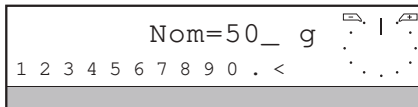

→ Enter numeric value of nominal weight in weight unit 1 "Unit1".
Possible values for "Nom": 0 ... max load. An entry outside the admissible range leads to the message "Illegal value".

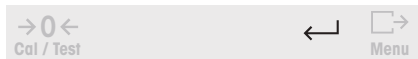

→ Confirm entry with ←.

This automatically sets the tolerance limits to $\pm 2.5\%$ of the nominal weight first entered. If you wish to retain these limits, press ← again.

b) Setting nominal weight using the "Set100%" function

This function is available only if the parameter "+/-%" is activated (marked) in the menu under "+/-Stats".

→ Place reference (nominal) weight on weighing pan.

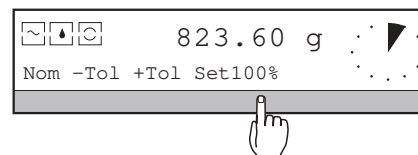

→ Press SmartBar under "Set100%". The display shows 100% after the stability was reached.

The tolerance limits +Tol and -Tol are automatically set to $\pm 2.5\%$ of the nominal weight. If you wish to retain these limits, press ←.

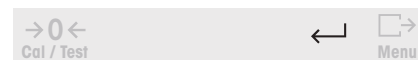

c) Changing tolerances

Depending on whether or not the parameter "+/-%" is activated in the menu under this application, the tolerances are inputted in percent of the nominal weight or as absolute weight values in weight unit 1.

→ Press SmartBar under "-Tol", "-T=..." is displayed in the top line.

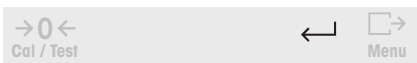
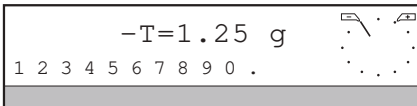
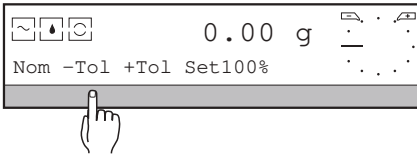

→ Enter numeric value of negative tolerance (deviation to lower values) in the displayed unit.

Possible values for "-T": 0 ... max. load or 0 ... 100 %. An entry outside the admissible range leads to the message "Illegal value".

→ Confirm entry with ←.

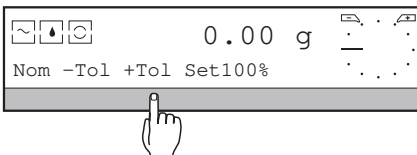

→ Press SmartBar under "+Tol", "+Tol=..." is displayed in the top line.

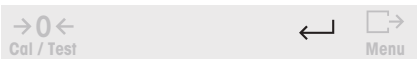
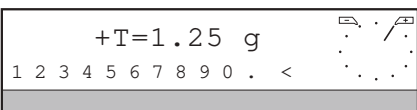

→ Enter numeric value of positive tolerance (deviation to higher values) in the displayed unit.

Possible values for "+T": 0 ... max. load or 0 ... 100 %. An entry outside the admissible range leads to the message "Illegal value".

→ Confirm entry with ←.

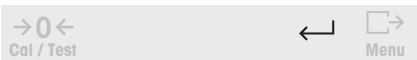

→ If the settings of nominal weight and tolerances meet your requirements, press ← again.

2. Checking weight of samples and/or performing statistics

Depending on the setting of "Mode" and "WeightEntry" under the "+/-Stat" application in the menu (section 6.1.5), plus/minus statistics proceeds in one of 4 ways:

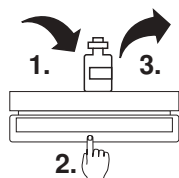

Weight check on samples placed on pan singly with manual weight transfer)
(Factory setting: Mode = Single, WeightEntry = Manual)

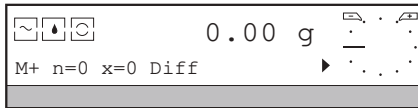

→ Place sample on weighing pan.
The position of the DeltaTrac pointer is a graphical indication of the relation of the weight to the nominal value.

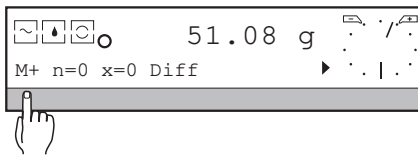

→ Press SmartBar under "M+".

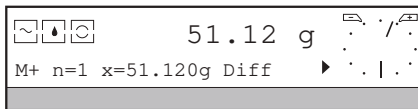

The next stable weighing result, visible in the top line, is incorporated in the calculation.
The item counter "n=..." is incremented and the result shown in the bottom line updated.



→ Remove sample from pan, add next sample, press SmartBar under "M+" etc.
The weighing result is not transferred until the load attains at least the value "MinChange" (set in the menu, see section 6.1.5), otherwise the message "MinChng - Err" appears.

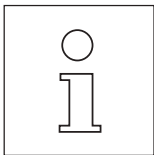

- You can also use plus/minus statistics with the setting "Mode = Single, WeightEntry = Manual" for weighing several samples of equal weight by entering the target weight as nominal weight and then working just with the METTLER DeltaTrac display. You can tare the balance before every weighing or use the basic function "PreTare" (section 4).
- You can also initiate the weight transfer using the LC-FS foot switch (Optional equipment, section 7.3). The foot switch must be set to switch position 4  for this. You thus have both hands free and need not touch the balance.

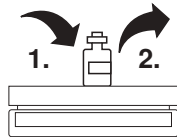

Samples placed on pan singly with automatic weight transfer
(Mode = Single, WeightEntry = Auto)

The first weight must be transferred manually.

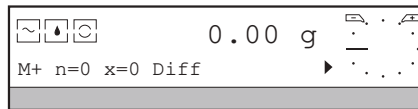

→ Place sample on weighing pan.
In the weight check, the position of the DeltaTrac pointer is a graphical indication of the relation of the weight to the nominal value.

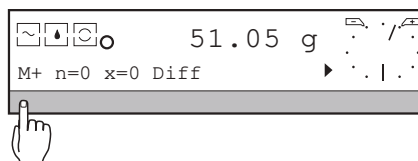

→ Press SmartBar under "M+".

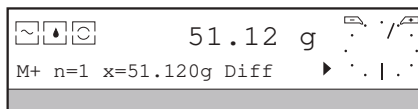

The first stable weight value (n=1) is transferred.
The item counter "n=..." is incremented and the result displayed in the bottom line updated.

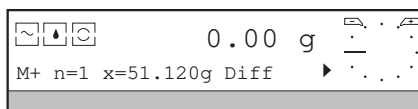

→ Unload balance by at least the value of "MinChange" (see section 6.1.5), place next sample on pan, wait for stability, etc.
The next stable weighing result, shown in the top line, is automatically transferred for the calculation.

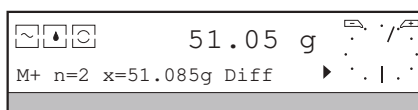

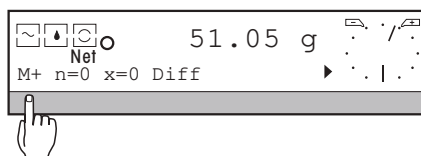
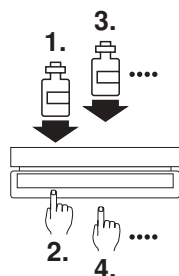

Weight check without sample removal from pan and with manual weight transfer

(Mode = Additive, WeightEntry = Manual)

→ Place container in center of weighing pan and tare.

→ Place sample in the container.

In the weight check, the position of the DeltaTrac pointer is a graphical indication of the relation of the weight to the nominal value.

→ Press SmartBar under "M+".

The next stable weighing result, visible in the top line, is incorporated in the calculation.

The display is automatically set to zero, the item counter "n=..." incremented and the result shown in the bottom line updated.

→ Add next sample to pan.

→ Press SmartBar under "M+" etc.

So that the sample can be transferred, the load change must attain the value "MinChange" (see section 6.1.5).

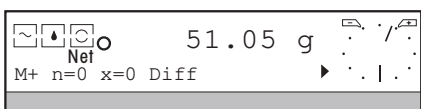
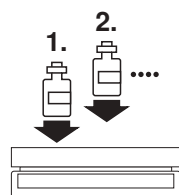

Weight check without sample removal from pan and with automatic weight transfer

(Mode = Additive, WeightEntry = Auto)

The first weight must be transferred manually.

→ Place container in center of weighing pan and tare.

→ Add sample to container.

In the weight check, the position of the DeltaTrac pointer is a graphical indication of the relation of the weight to the nominal value.

→ Press SmartBar under "M+".

The first stable weight value (n=1) is transferred.

The item counter "n=..." is incremented and the result displayed in the bottom line updated. The display is set to zero.

→ Place next sample on pan, wait for stability, etc. The subsequent weight values are automatically transferred for the calculation. The balance must attain the load change "MinChange" for transfer to occur.

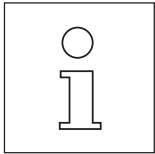

- If you wish, you can set the display to zero with the tare key $\rightarrow T \leftarrow$ before placing the sample on the pan.
- If the parameter "+/-%" is activated in the menu under "+/-Stats" (section 6.1.5), all weighing results appear in percent of the nominal weight. Switching to the weighing unit is possible.
- You can classify your samples according to the measured weight using the Input/Output Module LC-IO attached to the balance (section 7.3). The outputs will be activated according to the following table:

Active output no.	when weight value (wv) is
1 (for 0.3 sec)	entered by pressing "M+" or automatically
2	stable
3	$wv < \text{Nominal} - 2 * (-\text{Tol})$
4	$\text{Nominal} - 2 * (-\text{Tol}) \quad wv < \text{Nominal} - (-\text{Tol})$
5	$\text{Nominal} - (-\text{Tol}) \quad wv < \text{Nominal}$
6	$\text{Nominal} \quad wv \quad \text{Nominal} + (+\text{Tol})$
7	$\text{Nominal} + (+\text{Tol}) < wv \quad \text{Nominal} + 2 * (+\text{Tol})$
8	$wv > \text{Nominal} + 2 * (+\text{Tol})$

3. Displaying the calculated results

The calculated results of the series can be called up in succession and one of them always shown during weighing.

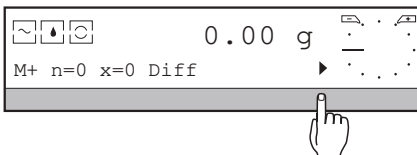

→ Press SmartBar under "►".

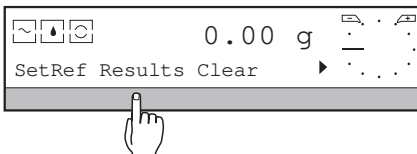

→ Press SmartBar under "Results".

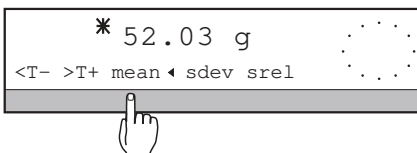

The bottom line of the display shows the selection of the following results, whose values appear in the top line marked by "*".

- "<T-" number of weighed samples below the lower tolerance
- ">T+" number of weighed samples above the upper tolerance
- "mean" mean value (factory setting)
during weighing, "x=..." appears in the bottom line of the display
- "sdev" standard deviation
during weighing, "s=..." appears in the bottom line of the display.
- "srel" relative standard deviation (standard deviation in % of the calculated mean value)
during weighing, "srel=...%" appears in the bottom line of the display.
- "min" smallest weighed value
- "max" largest weighed value
- "sum" sum
during weighing, " $\Sigma=...$ " appears in the bottom line of the display.

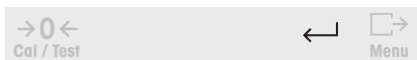

→ Press SmartBar under the desired result.

The selected result is marked by "♦" and its value displayed in the top line.

→ Confirm selection with \leftarrow .

From now on, the selected result is always shown in the bottom line during weighing.

4. Weight check with specified number of samples

If a preset number of samples has been entered, the balance prints out the final results when this number of items is reached and the balance has been unloaded. At the same time, the series is ended automatically and the results are cleared.

Entering the number of items

→ Press SmartBar under "n=...", "Max n=..." appears in the top line of the display.

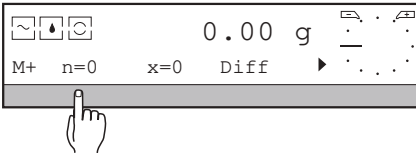

→ Enter numeric value of series size.

Possible values: 1 ... 999, with "Max n=0" the number of items is not specified (factory setting). An entry outside the admissible range leads to the message "Illegal value".

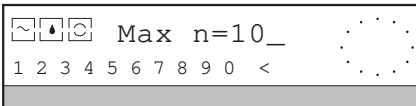

→ Confirm entry with ↵.

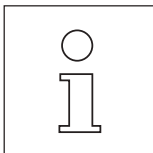
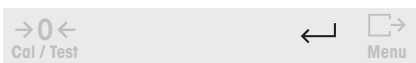

If you attempt to incorporate more samples in the calculation than specified, the message "n=Max n" appears in the display. To transfer additional weight values for the calculation, you must first increase "Max n" or set it to zero.

5. Switching the display between absolute value and difference to nominal weight

A nominal weight must be entered for this.

→ Press SmartBar under "Diff".

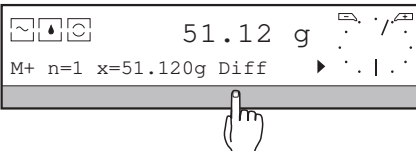

The top line shows the difference to the nominal weight (absolute or in % of the nominal weight), marked by "*". In the bottom line of the display the selection switches to "Abs".

→ Press SmartBar under "Abs".

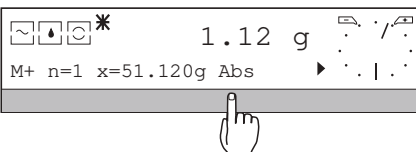

The top line of the display shows the sample weight (absolute or in % of the nominal weight), in the bottom line of the display the selection switches to "Diff".

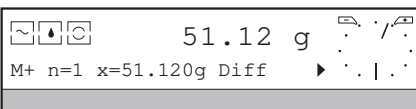

6. Switching the display between weight unit and percent

If the parameter "+/-%" is activated in the menu under the "+/-Stats" application, all weighing results automatically appear in percent of the nominal weight. For switching to the weighing unit and the converse:

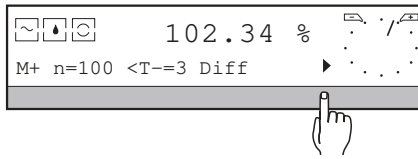

→ Press SmartBar under "►" repeatedly until the weight unit, e.g. "g" appears in the bottom line.

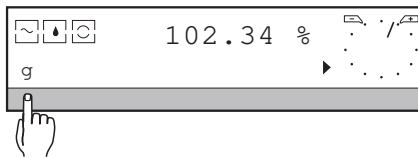
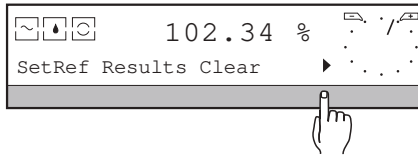

→ Press SmartBar under "g" (or the appropriate weighing unit, see section 4).

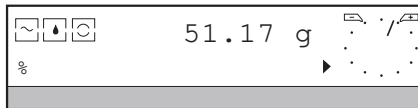

The top line of the display shows the result in the weighing unit, in the bottom line the selection switches to "%".

→ Press SmartBar under "%".

The top line shows the result in %, in the bottom line the selection switches to "g".

7. Ending the series of weight checks

→ Press SmartBar under "►".

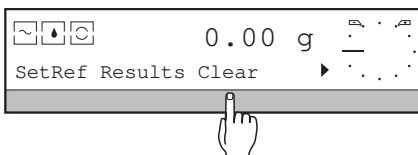
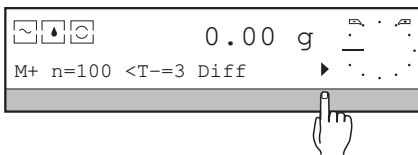

→ Press SmartBar under "Clear".



The series is ended. If a printer is attached, the current status of the item counter and the results will be printed out if not already done (see "Printout" section). Finally, the item counter and all results are set to zero. The reference values "Nom", "+T" and "-T" are retained.

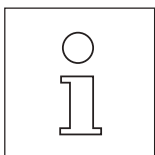

- The series is closed automatically if you work with the preset number of samples "Max n" and remove samples from the balance or if you switch off the balance.
- So that you can undertake settings in the menu, you must first close the weighing series.

```

---- +/- STATISTICS ----
17.06.95      10:36:04
Type:        PR5002DR
SNR:         1114051374
Bal:         Your entry

Nominal:     50.00 g
-Tol:        1.25 g
+Tol:        2.50 g
Max n:       5
1            50.19 g
2            50.47 g
3            55.81 g

n            5
<T-         1
>T+         1
x            50.712 g
s            3.364 g
s rel       6.63 %
min         46.36 g
max         55.81 g
max-min     9.45 g
sum         253.56 g

----- END -----

```

Printout

The printout of a sample series includes the following:

- Name of the application "+/- STATISTICS".
- Header lines, if set in the menu.
- Nominal weight with tolerance limits and preselected number of items "Max n".
- Sample size "Max n", if specified.
- Individual weight of each sample (absolute or as difference to nominal weight).
- Number of weight values actually transferred (number of items "n").
- All results "<T-", ">T+", "mean", "sdev", "srel", "min", "max", and "sum".
- Result "max-min", i.e. difference between the largest and smallest value.

If the weight values are displayed in % of the nominal weight, the results on the printout will also appear in %.

All results are printed out if the SmartBar is pressed under the visible result, e.g. "<T-=..." or if the plus/minus statistics has been ended with "Clear" or automatically.

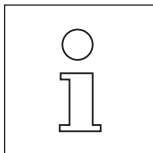

- If you have set the parameter "WeightTransfer" to "Manual" under "SYSTEM -> Printout" in the menu, you can print out the weight values with  if they are in the top line of the display.
- You can also activate the extended basic functions series and sample identification, as well as unit switching for +/- statistics. But the switching between different units is not possible if the first weight was weighted using "Custom Unit" with "1/x" activated (see section 6.2.5).
The basic tare preset function "PreTare" is especially suitable here for checking the net weights of samples which are weighed in containers of the same weight, see section 4.4.

5.5 Formulation – "Formula "

If you prepare mixtures of components in accordance with a formula and wish to document the composition, you will find the "Formula" application indispensable.

With a single keystroke, you can print out a record of your weighings. If desired, you can give every component an alphanumeric identification. If you wish the record to show not only the weight of the component but also the target weight, you can enter this numerically. You can then use the METTLER DeltaTrac with its +/- display for active support during additions.

In the "Formula" application you have the following functions and information available in the bottom line of the display:

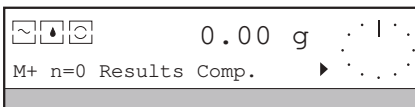

- "M+" transfers the weighed value to the total weight of the formula
- "n=..." item counter with number of weighed components
- "Results" selection of one of the 5 results which should always be shown in the top line during weighing: component weight, its difference to the target weight, net weight of all weighings together, gross weight and tare weight
- "Comp." entry of target weight and identification name of the next component, if desired
- "Clear" sets the item counter and the results to zero, ends the formula extended basic functions (see section 4) if activated in the menu

Requirement

The application "Formula" must be selected under "APPL" in the menu.

1. Weighing in the components of a mixture in accordance with directions

For weighing-in according to a set of directions (formula), there are two possibilities:

Weighing in the components without entry of target weight

→ Remove any load from balance, zero balance with →0← key.

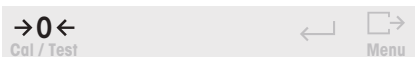

→ Place tare vessel on weighing pan, the tare weight is displayed.

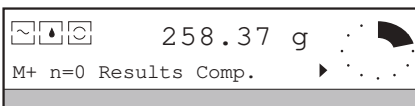

→ Tare balance with →T← key.

The next stable weight value is stored as the tare weight "TareWgt", the symbol "Net" appears in the display.

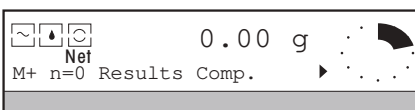

→ Weigh in first component of the formula.

→ When the desired weight, visible in the top line, is reached, press SmartBar under "M+".

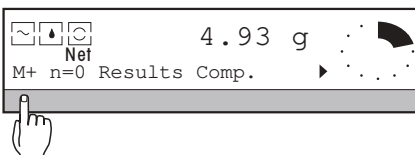

The next stable weighing result is transferred to the net memory, the display is automatically set to zero and the item counter "n=..." incremented.

→ Weigh in next component, press SmartBar under "M+" etc.

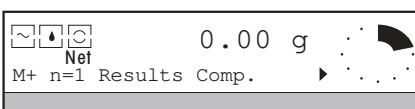

Weighing in the components with entry of identification name and/or target weight



→ Remove any load from balance, zero balance with →0← key.

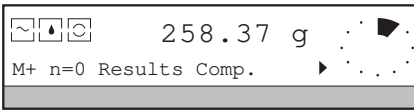

→ Place tare vessel on weighing pan, the tare weight is displayed.



→ Tare balance with →T← key.

The next stable weight value is stored as the tare weight "TareWgt", the symbol "Net" appears in the display.

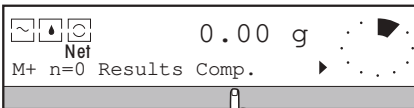

→ Press SmartBar under "Comp.".

Entering identification name



→ Press SmartBar under "SampleID", "SID=..." appears in the top line.

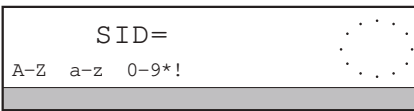

→ Enter alphanumeric identification of the component, see section 3.9.

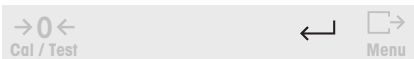

→ Confirm entry with ↵.

If you do not wish to enter a target weight, press ↵ again. Balance returns to the weight display and the weighing can be performed.

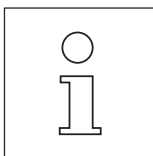

- You always have the entry of the identification name of the component "SampleID" available under the parameter "Comp."
- **During the formulation you should never zero the balance with the →0← key**, otherwise the data of the weighings performed so far will be lost.
- You can also transfer the component weight using the LC-FS foot switch (Optional equipment, section 7.3). The foot switch must be set to switch position 4 (↶) for this. You thus have both hands free and need not touch the balance.

Entering target weight

→ Press SmartBar under "Weight", "Trg=..." appears in the top line of the display.

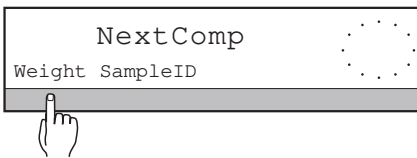

→ Enter numeric value of target weight in weight unit 1 ("Unit1"). Possible values for "Trg": 0 ... max. load. An entry outside the admissible range leads to the message "Illegal value".

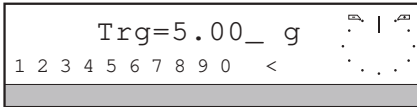

→ Confirm entry with ↵.



→ Press ↵ again, the balance returns to the weight display.

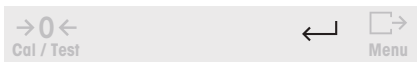

The METTLER DeltaTrac changes to the +/- display with pointers. Both pointers point to 9 o'clock. If "CmpDiff" has been selected under "Results", the top line switches to the display of the difference to the target weight, i.e. the preset target value appears with a negative sign, marked by a "*".

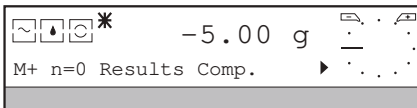

→ Weigh in first component of the formula.

When the weight approaches the target weight, the display approaches zero and the pointers of the DeltaTrac reach the 6 o'clock position. The tolerance markers correspond to a deviation of ±2.5 % from the target weight.

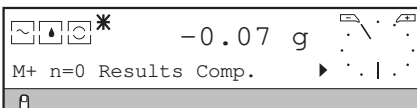

→ Press SmartBar under "M+".

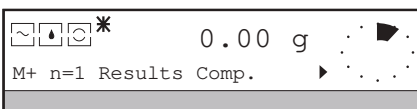

The next stable weighing result is transferred to the net memory, the display is automatically set to zero and the item counter "n=..." incremented. At the same time, the preset value of the target weight is cleared and the DeltaTrac automatically returns to the display of the remaining range.

2. Displaying the component weight or its difference to the target weight, and the net, gross and tare weight

The current component weight and its difference to the target weight "CmpWgt" and "CmpDiff" and the results net weight "NetTot" and gross weight "Gross" of the mixture as well as the tare weight "TareWgt" can be called up and one of them always shown in the top line of the display during weighing.

→ Press SmartBar under "Results".

The bottom line of the display shows the following selection (the value currently displayed is marked by "←"):

"CmpWgt" Display of the weight of the current component (factory setting)

"CmpDiff" Display of the difference between the component weight and the target weight if the latter has been entered.

"NetTot" Display of the total weight of all components weights transferred so far (net total). You thus have the possibility to add the last component to a desired total weight.

"Gross" Display of the total weight on the balance (Gross = TareWgt + NetTot)

"TareWgt" Display of the tare weight.

→ Press SmartBar under the desired weight value.

The selected value is marked by "←" and displayed in the top line.

→ Confirm selection with ←.

From now on, the selected value is always shown in the top line during weighing and is identified as follows:

"CmpWgt" Weight value with "Net"; identified on the printout by "N"

"CmpDiff" Weight value with "*"; identified on the printout by "diff"

"NetTot" Weight value with "T Net"; identified on the printout by "net tot"

"Gross" Weight value identified by "G"

"TareWgt" Weight value marked by "T" and "*" (remains the same when load changes)

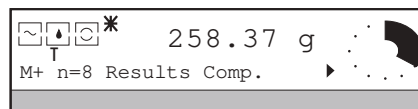
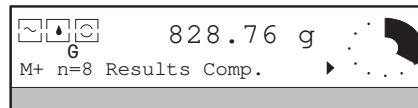
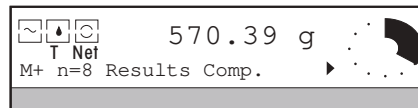
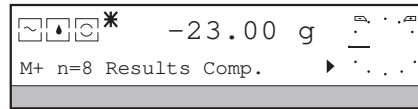
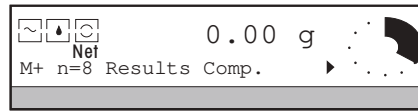
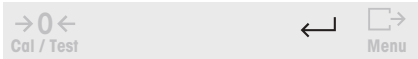
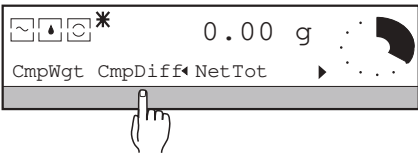
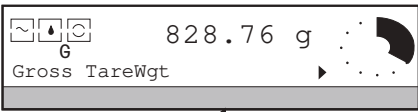
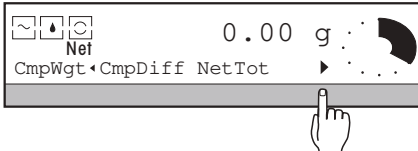
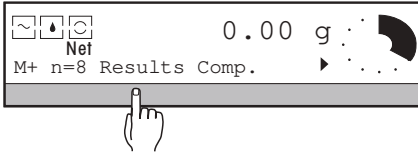

3. Ending the formulation

→ Press SmartBar under "►".

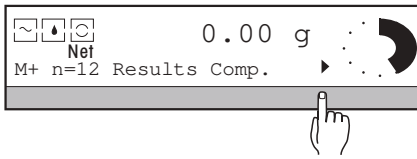

→ Press SmartBar under "Clear" and unload the balance.

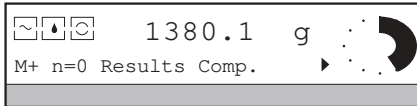
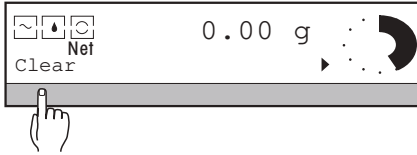

The formula is ended. The current status of the item counter and the results are printed out if not already done and if a printer is attached. Finally, the item counter and all results (net, gross, tare) are set to zero.

Printout

The printout of a completed formulation includes the following:

- Name of the application "FORMULATION"
- Header lines, if set in the menu
- Identification name "ID" of the component, if entered
- Target weight of the component "Trgt", if entered
- Net weight actually weighed in of nth component with "N"
- Difference to target weight in % if target weight has been entered
- Number of weighed-in components (number of items "n=...")
- Net weight of the mixture "net tot"
- Gross weight of the mixture "G"
- Weight of the tare container "T"

```

----- FORMULATION -----
07.06.95          10:36:04
Type:             PR8002DR
SNR:              1114051374
Bal:              Your entry
ID:               M-123
1 Trgt:           6.20 g
1 N               6.17 g
1 diff            -0.48 %
ID:               C-803
2 Trgt:           52.00 g
2 N               51.81 g
2 diff            -0.37 %

-----
n                 5
net tot           102.52 g
G                 169.45 g
T                 66.93 g
----- END -----

```

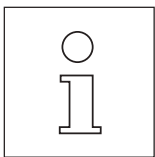

You can also activate the extended basic functions series identification, tare preset and unit switching in formulation, see section 4.

6 Menu

You use the menu to set the **wide range of functions** of the PR/SR balances so that they meet your needs and allow you to make optimum use of the balance.

For example, you can select the **weighing application**, specify the **behavior of the balance** during weighing to match the surroundings and the weighing mode or select the desired **weighing unit**.

Further, you can define the **type of calibration (adjustment)** and **test** as well as set **general options** such as balance identification, date, time, type of result printout, etc.

You will find a detailed description of the menu options in the following sections.

How to set options in the menu:

Entry into menu

Press and hold the  key until "MENU" appears in the top line of the display; the bottom line shows the selection "APPL WEIGH CAL SYSTEM ▶". Press "▶" to move to the last item "LANGUAGE". If entry into the menu is protected by a password, first enter the password.

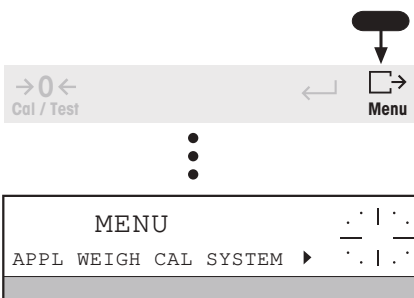

Select setting

Press SmartBar under the desired setting, the desired parameter or press under "▶". The parameter is marked by "♦" or a further selection appears. Continue in this manner until the desired setting is marked or the parameters entered.

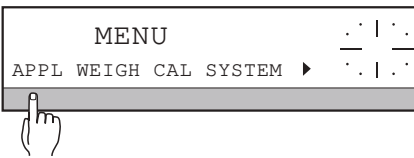

Confirm setting

Press  key, the bottom line of the display shows the preceding selection again.

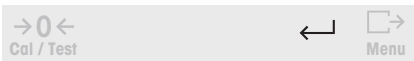

Return to preceding selection

Press  key.

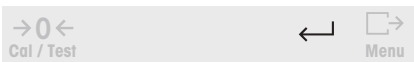

Return to start of menu

Press  key briefly.

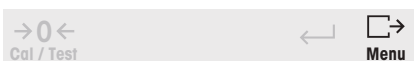

Quit menu and save settings

Press and hold  key until "Stored" appears in the top line.



Quit menu without saving settings

Press **C** key. When quitting the menu from an alphanumeric entry: press **C** key twice.



Overview

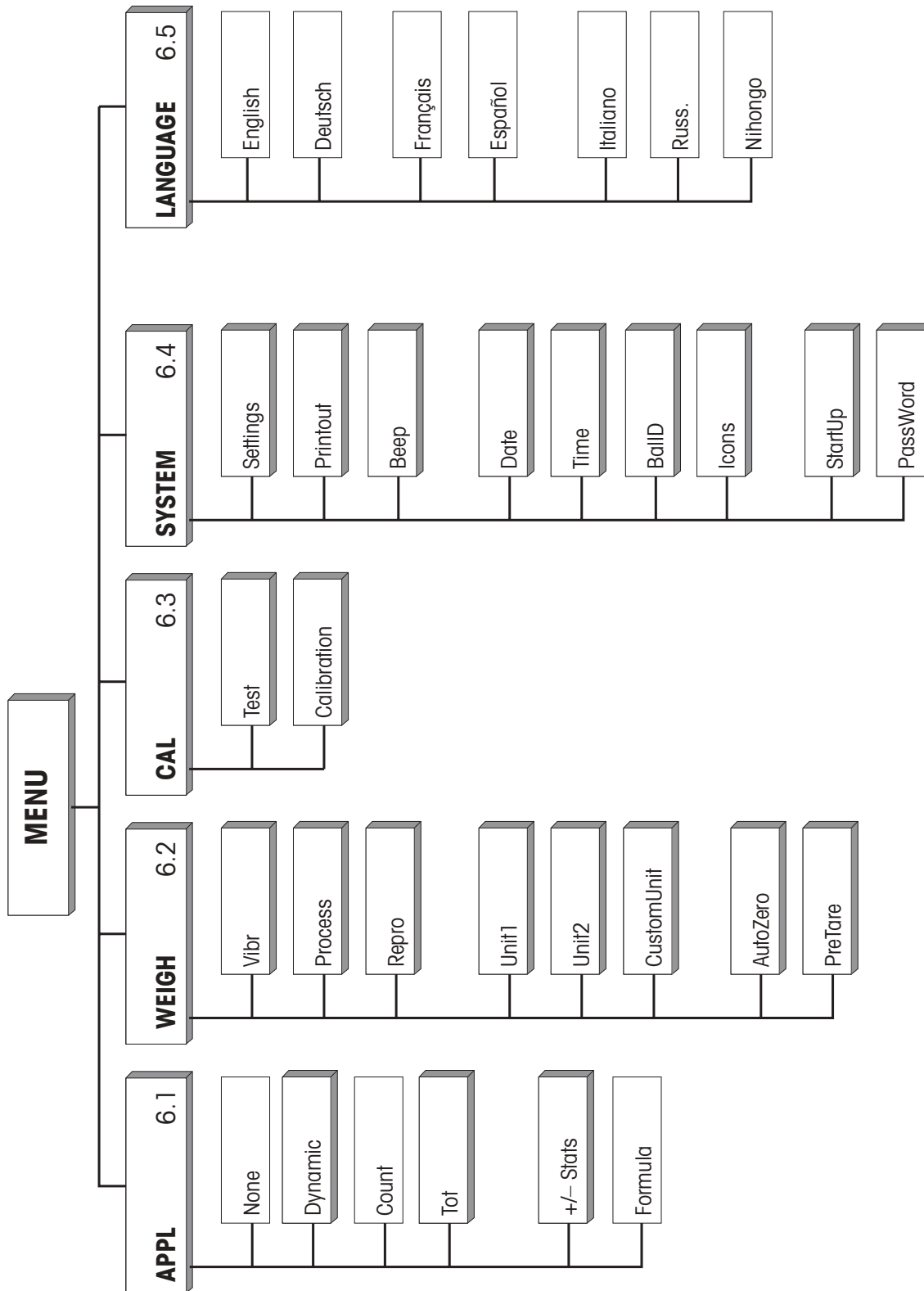

Overview of the weighing applications, the APPL menu

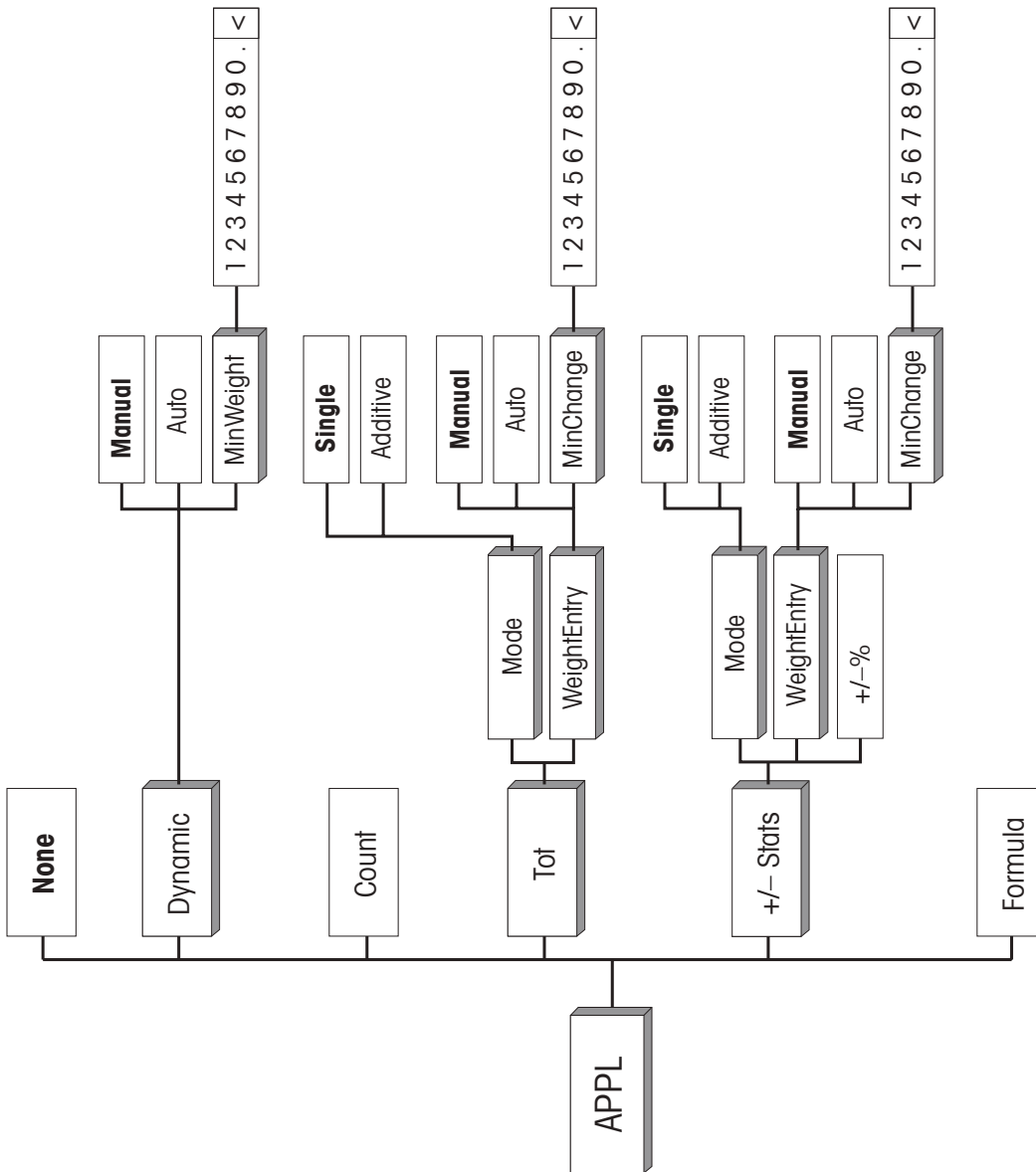

Note
Factory settings are in **boldface**.

Overview of the weighing parameters, the WEIGH menu

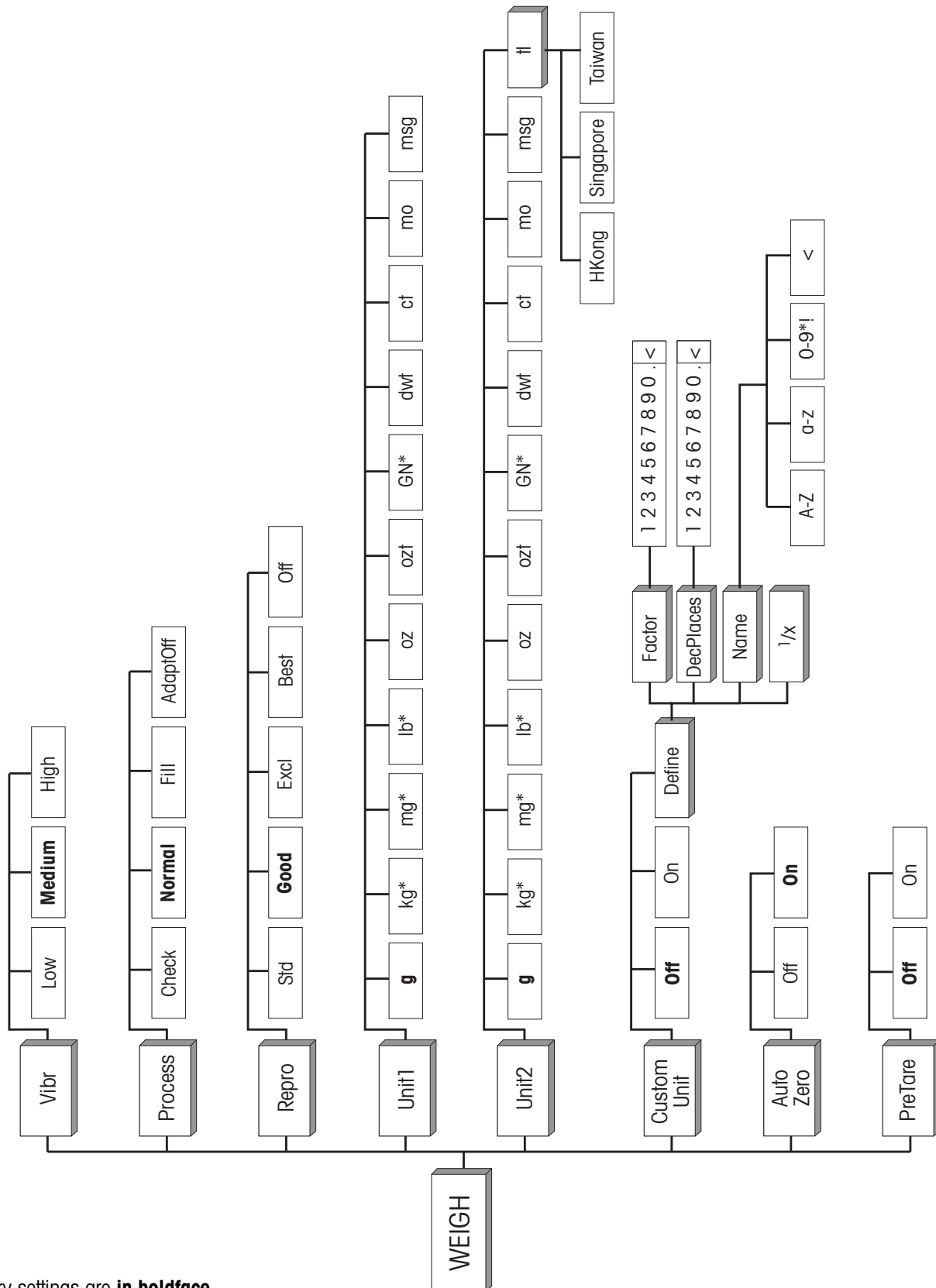

Note
 Factory settings are **in boldface**.
 * Not available with all balance models.

Overview of the calibration (adjustment) and test functions, the CAL menu

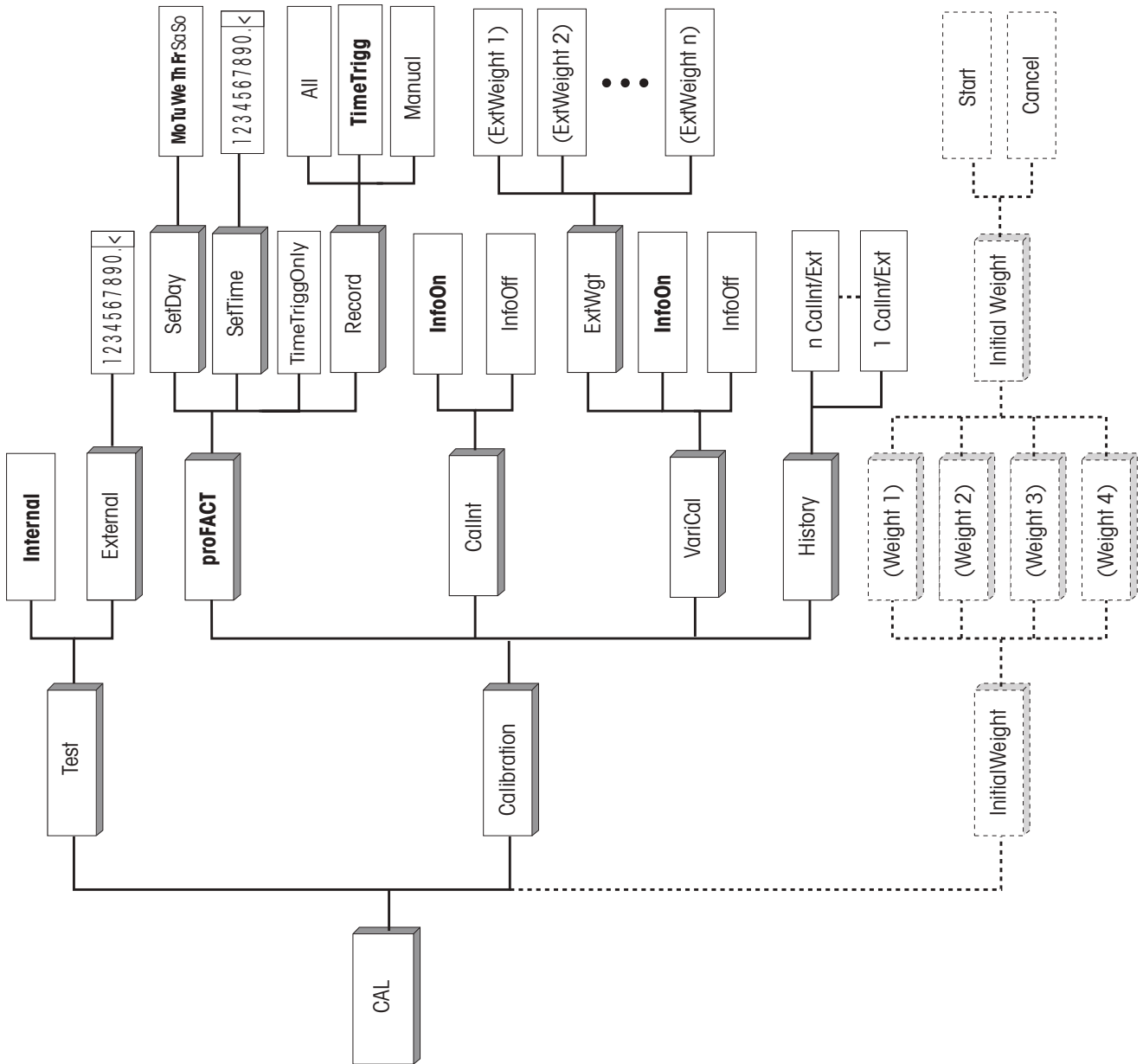

Note
Factory settings are in **boldface**.

Overview of the documentation parameters of the weighing results, the SYSTEM menu

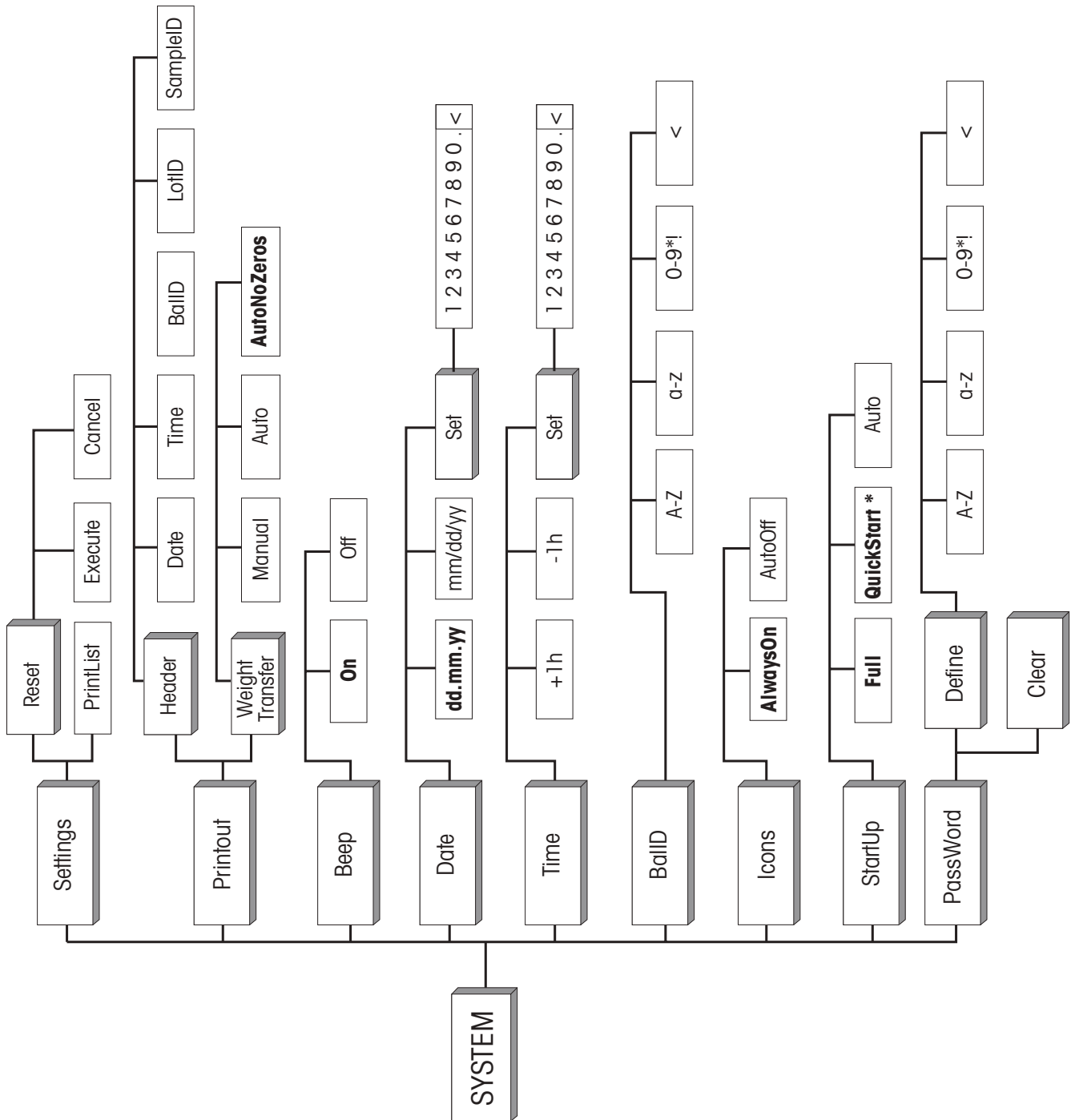

Note

Factory settings are in **boldface**.

* With certified balance models, the factory setting is "Full".

6.1 Selecting weighing application – " APPL "

Under the menu option "APPL" you can select the desired weighing application and match it to your mode of operation.

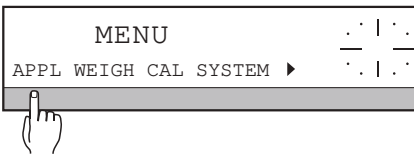

→ Press and hold  key until "MENU" appears in the top line of the display, if applicable enter the password "PASSW= ..." and confirm with the \leftarrow key.

→ Press SmartBar under "APPL".

The following selection of weighing applications appears:

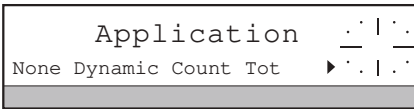

"None" Simple weighing (factory setting, section 6.1.1)

"Dynamic" Dynamic weighing (section 6.1.2)

"Count" Piece counting (section 6.1.3)

"Tot" Totalize weight values (section 6.1.4)

"+/-Stats" Plus/minus statistics, weight check (section 6.1.5)

"Formula" Formulation of mixtures (section 6.1.6)

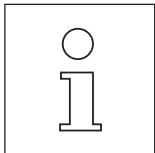

You can also activate the following basic functions for every weighing application:

- Unit switching, see section 6.2 "WEIGH" under "Unit2" and "CustomUnit".
- Tare preset, see section 6.2 "WEIGH" under "Tare".
- Entry of series and sample identifications as well as printout of header lines, see section 6.4 "SYSTEM" under "Printout -> Header".

6.1.1 Simple weighing

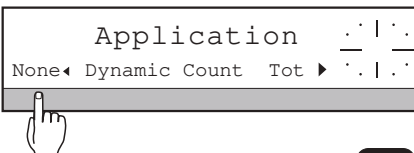

→ Select the application "None" under "Application".

No other parameters need be set for simple weighing.

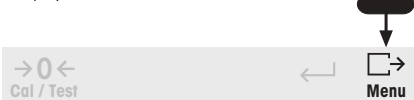

Quitting the menu and saving the setting

→ Press and hold  key until "Stored" appears in the top line. Then release key, balance returns to the weight display. The set application "SIMPLE WEIGHING" appears in the bottom line.

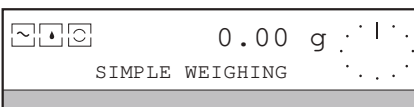

6.1.2 Dynamic weighing

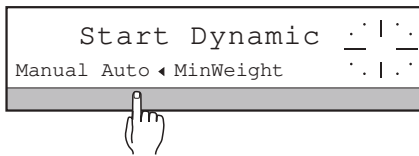
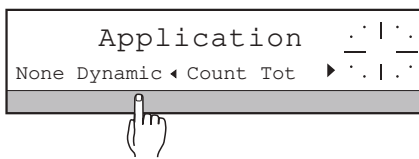

→ Select the application "Dynamic" under "Application".

→ Under "Start", select the way in which dynamic weighing should be started.

"Manual" Every dynamic weighing must be started by a keystroke (factory setting).

"Auto" The weighing starts automatically when a sample is placed on the pan.

"MinWeight" Enter numeric value of minimum load needed for automatic start of the weighing "MW= ..." and close with ← (factory setting: **MinWeight = 100 display increments**).



So that the next weighing can start automatically, the balance must first be unloaded to **below** the "MinWeight".

→ Confirm setting with  (return to main menu)

or

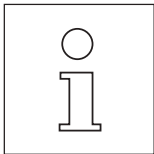
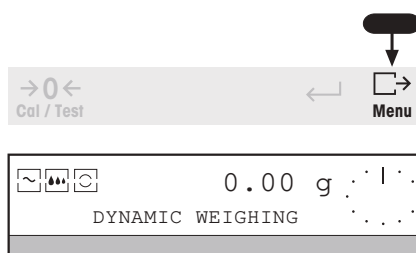
→ Press and hold  key until "Stored" appears in the top line. Then release key, balance returns to the weight display. The set application "DYNAMIC WEIGHING" appears in the bottom line. The settings are now stored. **Section 5.1 describes the operation of this weighing application.**



- You can also perform dynamic weighing with the factory settings (boldface). In this case all you have to do is select the application and save the selection by pressing and holding the  key.
- When dynamic weighing is active, the symbol  appears in the display during weighing.

6.1.3 Piece counting

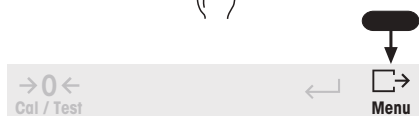
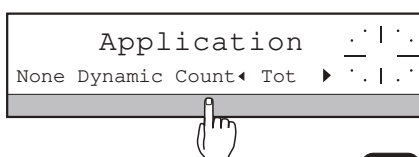

→ Select the application "Count" under "Application".

→ Confirm setting with  (return to main menu)

or

→ Press and hold  key until "Stored" appears in the top line. Then release key, balance returns to the weight display. The set application "PIECE COUNTING" appears in the bottom line. The settings are now stored.

All other parameters for piece counting can be set directly during weighing. **Section 5.2 describes the operation of this weighing application.**

6.1.4 Totalizing weight values

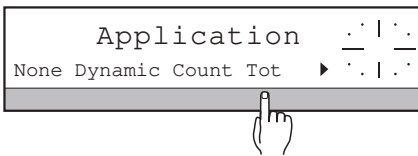

→ Select the application "Tot" under "Application".
The display shows the next selection.

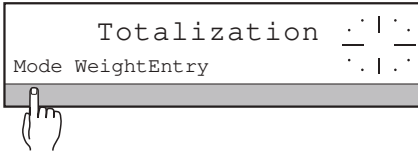

→ Under "Mode", specify how the samples should be placed on the balance.

"Single" Each sample is placed singly on the weighing pan (factory setting).

"Additive" The weighed sample remains on the weighing pan, the next is added to it. The samples are not removed from the balance until the end of the weighing series.



→ Confirm setting with ←.

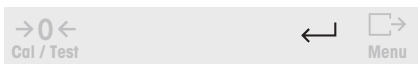

→ Under "WeightEntry", specify how the weighing result should be transferred to the total and what minimum load change must be attained for transfer.

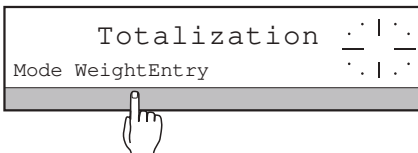

"Manual" The weighing result is transferred at a keystroke (factory setting).

"Auto" Each stable weighing result whose value attains the minimum weight is automatically added to the total.

"MinChange" Minimum load change needed for the weight transfer; enter numeric value of "MCh=..." and close with ← (factory setting: **MinChange = 100 display increments**).

→ Confirm setting with  (return to main menu)

or

→ Press and hold  key until "Stored" appears in the top line. Then release key, balance returns to the weight display. The set application "TOTALIZATION" appears in the bottom line. The settings are now stored. **Section 5.3 describes the operation of this weighing application.**

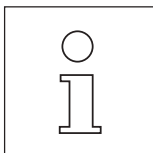
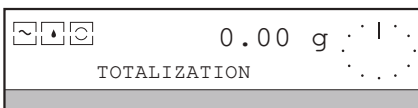
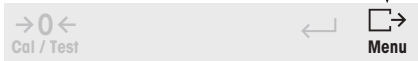
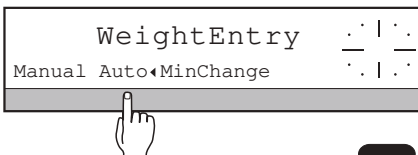

- You can also work with the factory settings (boldface). In this case all you have to do is select the application and save the selection by pressing and holding the  key.
- Weighing results are not added to the total until the balance has stabilized (see also section 6.2, "WEIGH" under "Repro").
- Please note that in the additive mode ("Mode" to "Additive"), the total weight of the samples must not exceed the maximum capacity of the balance. Otherwise, the series must be ended prematurely.

6.1.5 +/- Stats, checkweighing

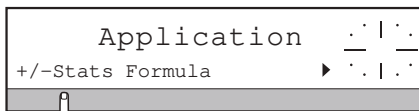

- Select the application "+/-Stats" under "Application".
The display shows the next selection.

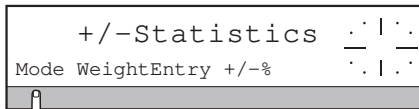

- Under "Mode", specify how the samples should be placed on the balance.

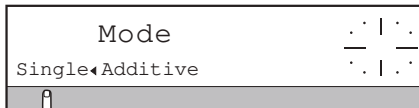

- "Single"** Each sample is placed singly on the weighing pan (factory setting).
"Additive" The weighed sample remains on the weighing pan, the next is added to it. The samples are not removed from the balance until the end of the weighing series.

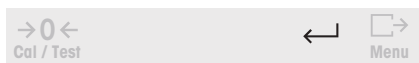

- Confirm setting with ←.

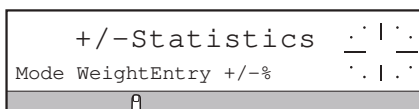

- Under "WeightEntry", specify how the weighing result should be transferred to the total and what minimum load change must be attained for transfer.



- "Manual"** The weighing result is transferred at a keystroke (factory setting).
"Auto" Each stable weighing result whose value attains the minimum weight is automatically incorporated in the calculation.
"MinChange" Minimum load change needed for the weight transfer; enter numeric value of "MCh=..." and close with ← (factory setting: **MinChange = 100 display increments**).

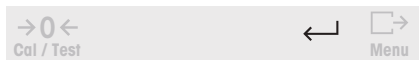

- Confirm settings with ←.

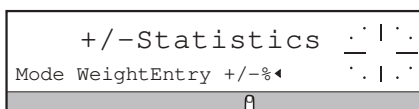

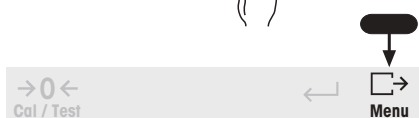

- Select (mark) "+/-%" if the tolerance limits for the checkweighing and the weighing results should be entered or displayed in % of the nominal weight and / or if the nominal weight should be set by weighing a reference weight (function "Set100%"). Switching to display of the results in the weight unit is always possible.



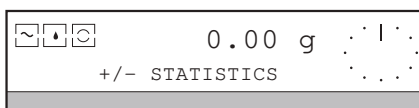

- Confirm settings with  (return to main menu)

or

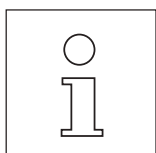

- Press and hold  key until "Stored" appears in the top line. Then release key, balance returns to the weight display. The set application "+/-WEIGHING" appears in the bottom line. The settings are now stored. **Section 5.4 describes the operation of this weighing application.**



- You can also work with the factory settings (boldface). In this case all you have to do is select the application and save the selection by pressing and holding the  key.
- Weighing results are not incorporated in the calculation until the balance has stabilized (see also section 6.2, "WEIGH" under "Repro").
- Please note that in the additive mode ("Mode" to "Additive"), the total weight of the samples must not exceed the maximum capacity of the balance. Otherwise, the series must be ended prematurely.

6.1.6 Formulation



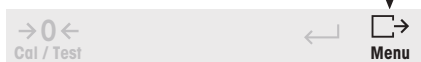

→ Select the application "Formula" under "APPL".

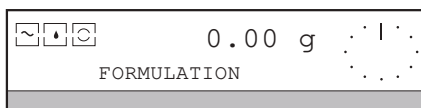

→ Confirm setting with  (return to main menu)

or



→ Press and hold  key until "Stored" appears in the top line. Then release key, balance returns to the weight display. The set application "FORMULATION" appears in the bottom line. The setting is now stored.

All other parameters for processing the formula can be set directly during weighing. **Section 5.5 describes the operation of this weighing application.**

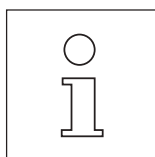



- Weighing results are not incorporated in the calculation until the balance has stabilized (see also Section 6.2. "WEIGH" under "Repro").
- Please note that the total weight of the formulation including that of the container must not exceed the maximum capacity of the balance. Otherwise, the formulation must be ended prematurely.

6.2 Setting weighing parameters – "WEIGH"

Under the menu option "WEIGH" you can set the behavior of the balance and display as well as general weighing parameters such as weight units to meet your needs and the requirements of the balance location in an optimum manner.

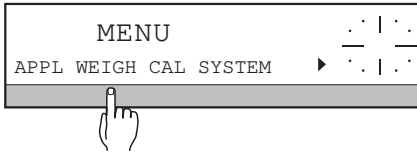
Functions such as the second weight unit or tare preset, which you have available with all weighing applications, can also be set here.



- Press and hold  key until "MENU" appears in the top line of the display, if applicable enter the password "PASSW= ..." and confirm with the ← key.
- Press SmartBar under "WEIGH".

The bottom line of the display shows the following selection:

- "Vibr" Matching to the location of the balance with regard to ambient influences such as drafts (section 6.2.1)
- "Process" Matching to the type of weighing, e.g. weighing in or weight determination (section 6.2.2)
- "Repro" Matching to your needs with regard to repeatability and display update speed of stable results (section 6.2.3)
- "Unit1" Weight unit 1 (section 6.2.4)
- "Unit2" Weight unit 2 (section 6.2.4)
- "CustomUnit" A unit freely definable by the user with or without user defined name via a multiplication factor (section 6.2.5)
- "AutoZero" Automatic zero correction (section 6.2.6)
- "PreTare" Tare function, tare preset (section 6.2.7)

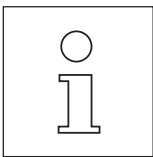

With certified balance models, certification regulations may prevent you setting certain parameters.

6.2.1 Matching the balance to the location – " Vibr "



→ Select the weighing parameter "Vibr" under "Weighing".
The display shows "Vibrations" and the symbol  with its current setting.

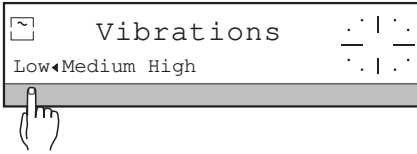

→ In the bottom line of the display mark the setting appropriate to the ambient conditions (vibrations, drafts) at the balance location.

- "Low" Stable balance surroundings
The balance operates quickly, but is sensitive to external vibrations.
- "Medium" Normal balance surroundings (factory setting)
- "High" Unstable balance surroundings, vibrations, e.g. from machines or floor oscillations
The balance operates more slowly, but is less sensitive to vibrations.

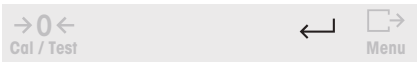

→ Confirm settings with ← and return to preceding selection.



6.2.2 Matching the balance to the type of weighing – " Process "



→ Select the weighing parameter "Process" under "Weighing".
The display shows "WghProcess" and the symbol  with its current setting.

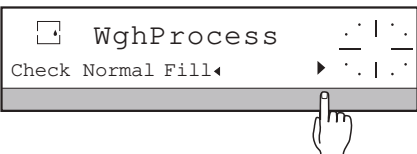

→ Mark the setting appropriate to the weighing task at hand in the bottom line of the display.

- "Check" Setting for checkweighing, weight determination of samples
- "Normal" Universal setting (factory setting)
- "Fill" Setting for fine addition
- "AdaptOff" In this setting, the displayed weight value has a chronologically fixed relation to the weight change.

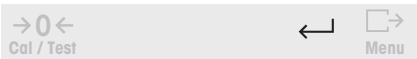

→ Confirm settings with ←, return to preceding selection.



6.2.3 Setting the repeatability of results – "Repro "



→ Select the weighing parameter "Repro" under "Weighing".

The display shows "ReproSet" and the symbol  with its current setting.



→ Mark the setting appropriate to the required repeatability and release speed of the weighing results in the bottom line of the display.

"Std" Normal repeatability, weight display released as stable particularly quickly, i.e. stability detector fades rapidly.

"Good" Good repeatability, weight display released as stable quickly (factory setting).

"Excl" Very good repeatability, slower release of weight display as stable.

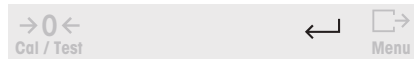

"Best" Best possible repeatability, weight display not released until several seconds without change.

"Off" Stability criterion virtually switched off (see information below). Not possible with certified balances.

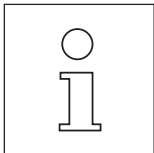

→ Confirm settings with  and return to previous choice.



- With the "ReproSet" setting you also use the release speed of the weighing result to determine the speed of the weight transfer in weighing applications. The faster the setting, the shorter the wait time for the transfer.
- If you have marked the "Off" setting, the balance executes the commands "tare balance" with  or "transfer result" with  Menu, although the result remains to be indicated stable.

6.2.4 Selecting weight unit 1 and weight unit 2 – " Unit1 ", " Unit2 "

If you select different weight units for the parameters "Unit1" and "Unit2", you can switch between these units in every application.

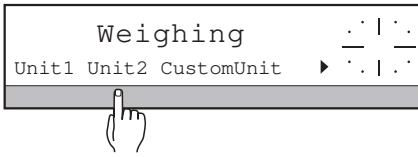

→ Select the weighing parameter "Unit1" or "Unit2" under "Weighing". "Unit1" or "Unit2" appears in the top line.

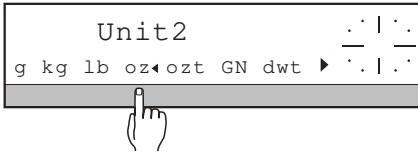

→ Mark the desired weight unit from the following selection:

"g"	gram		Factory setting
"kg"	kilogram	1 kg = 1000 g	not with balances with readability of 1 mg
"mg"	milligram	1 mg = 0.001 g	only with balances with readability of 1 mg
"lb"	pound	1 lb 453.59237 g	not with balances with readability of 1 mg
"oz"	ounce	1 oz 28.349523125 g	
"ozt"	Troy ounce	1 ozt = 31.1034768 g	
"GN"	grain	1 GN 0.06479891 g	not with balances with readability of 1 g
"dwt"	pennyweight	1 dwt 1.555173843 g	
"ct"	carat	1 ct = 0.2 g	
"mo"	momme	1 mo = 3.75 g	
"msg"	mesgal	1 msg 4.6083162 g	
"tl"	taels		available only with "Unit2"

Here, a further selection appears:

"Hkong"	Hong Kong taels	1 HKong tl 37.42900 g	only "tl" appears in weighing operation
"Singapore"	Singapore taels	1 Sing tl 37.799366256 g	only "tl" appears in weighing operation
"Tai"	Taiwan taels	1 Tai tl = 37.5 g	only "tl" appears in weighing operation

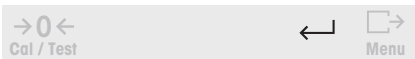

→ Confirm settings with ← and return to the preceding selection.

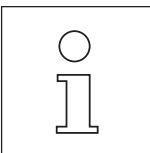

- Weight unit 1 ("Unit1") is the weighing unit which is displayed after the balance has been switched on.
- You can enter target weights (plus/minus statistics, formula) in the weight unit actually displayed.
- With certified balances, you may not be able to change the preset units.

6.2.5 Freely definable unit - "CustomUnit"

If you activate the unit you have defined, you can switch between this and the other units in every application. The displayed value in "CustomUnit" corresponds to the inputted factor "F" multiplied or divided by the weight determined by the balance in grams.

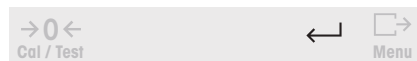
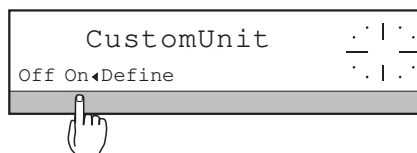
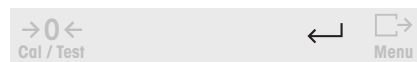
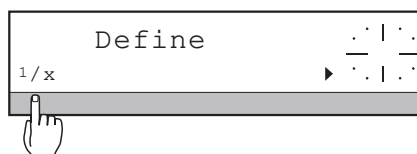
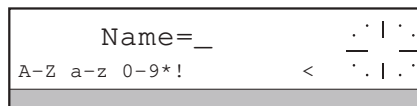
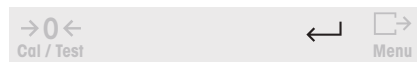
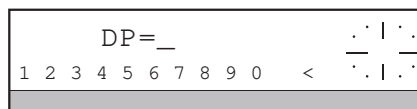
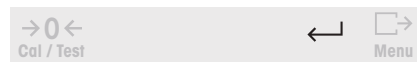
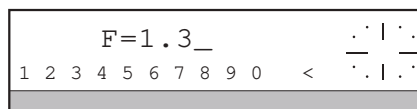
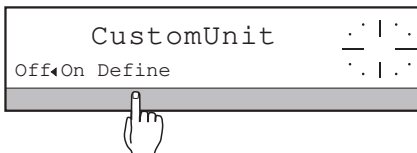
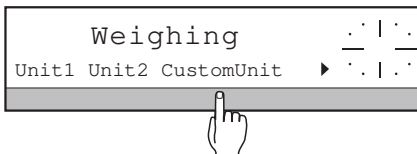

→ Under "Weighing", select the freely definable unit "CustomUnit".

The following selection appears in the bottom line of the display:

- "Off" CustomUnit not activated (factory setting)
- "On" CustomUnit available in weighing. Results appear followed by "[C]" or with user-defined name
- "Define" Define conversion factor, display format, name of "CustomUnit" or factor divided by weight "1/x" function.

→ Specify the unit under "Define".

→ Under "Factor", enter numeric value of the multiplication factor "F=..." (-sign first if factor negative), close entry with \leftarrow .

Possible values for "F": ± 0 to 100 000, factory setting: **F=1**.

If an entry is outside the admissible range, the message "Illegal value" appears.

→ Under "DecPlaces", enter the number of decimal places "DP=..." which should be displayed, close entry with \leftarrow .

Possible values for "DP": 0 to 7, factory setting: **DP=2**.

If an entry is outside the admissible range, the message "Illegal value" appears.

→ Enter alphanumeric characters of your designation of the custom unit "Name = " under "Name", confirm entry with \leftarrow .

Max. 4 characters are possible. Names of weight units, e.g. "g" or "oz" are not admissible. Factory setting: **Name = [C]**.

If entries are outside the admissible range, the message "Illegal value" appears.

→ Press the SmartBar under $1/x$ to activate this function, if you want to use your unit for conversion "**factor divided by weight**".

→ Confirm definition with \leftarrow and return to selection "Off On Define".

→ Press SmartBar under "On" to activate the "CustomUnit" you have defined.

→ Confirm settings with \leftarrow and return to previous selection.

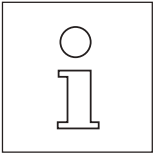

- If you enter values for "Factor" and/or "DecPlaces" which are too high, this can lead to an overflow of the weight display "*****".
- Negative factor can only be used with simple weighing.
- If you do not enter anything under "Name" or delete the entire name, your user-defined unit will be displayed and printed out with "[C]".

6.2.6 Automatic zero correction – " AutoZero "

The automatic zero correction assures you of a stable zero of the balance after zero setting even if the weighing pan becomes somewhat contaminated.

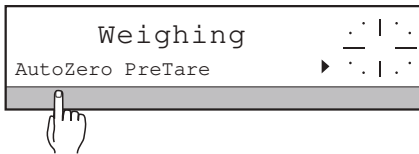

→ Select the weighing parameter "AutoZero" under "Weighing".

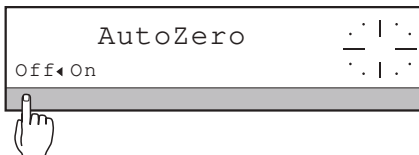

→ Mark the desired setting with the SmartBar:

- "Off" Automatic zero correction switched off.
With certified balance models, it may not be possible to switch off the automatic zero correction.
- "On" Automatic zero correction switched on (factory setting).

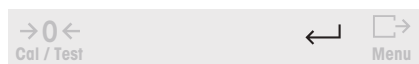

→ Confirm settings with ← and return to the preceding selection.



6.2.7 PreTare, printout of the tare weight value

The PreTare allows you to enter a known tare weight numerically or by weighing, to call up the current value and print it out.



→ Select the "PreTare" function under "Weighing".

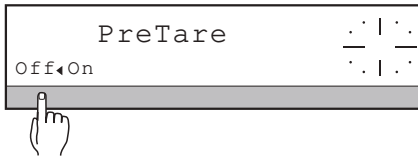

→ Mark the desired setting using the SmartBar:

"Off" The "PreTare" function is switched off (factory setting).

"On" The "PreTare" function is switched on. The current tare weight value will be automatically printed out with each net weight value. During weighing, "PT" appears in the bottom line.

→ Confirm settings with  (return to main menu)

or

→ Press and hold the  key until "Stored" appears in the top line.

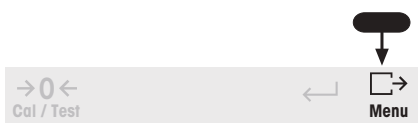

Then release key, balance returns to the weight display. The bottom line shows the name of the set application, e.g. "+/-STATISTICS". The setting is now stored.

Section 4.4 describes the "PreTare" function.

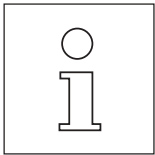

If you work with PreTare, each subsequent weight result appears in the top line of the display as a net value. This is indicated by the status display "Net" (see section 1.5).

6.3 Selecting the calibration (adjustment) and test function – " CAL "

When you set the parameters under "CAL", you define the manner in which you wish to calibrate (adjust) the balance and/or check its accuracy by a test. If you have attached a printer, the calibration (adjustment) data and/or the test results with all supplementary information are printed out automatically as recommended by GLP.

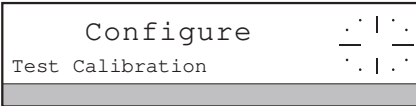
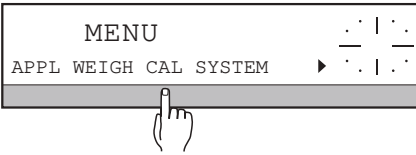

- Press and hold  key until "MENU" appears in the top line of the display, if applicable enter the password "PASSW= ..." and confirm with the ← key.
- Press SmartBar under "CAL".
"Configure" appears in the top line.

The bottom line shows the following selection:

- "Test" Specifies whether the accuracy test is performed with the internal or with a freely selectable external weight (section 6.3.1).
- "Calibration" Defines whether the balance is calibrated (adjusted) fully automatically and/or at a keystroke with the internal weight or whether an external weight of freely selectable value should be used (section 6.3.2).

6.3.1 Setting test mode – "Test"

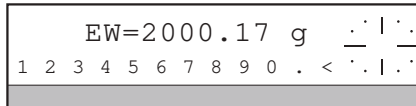
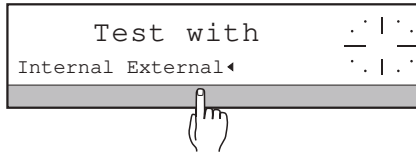
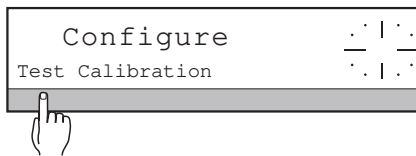

- Select "Test" under "Configure". The top line shows "Test with".

- Mark the desired setting using the SmartBar.
"Internal" Test with the built-in weight
"External" Test with external test weights

For regular testing of the balance by way of a control of inspection, measuring and test equipment conforming to GLP, it is advisable to perform the test with an external weight. Any weight can be used provided its value is always known accurately and it lies within the load range of the balance.

- Enter weight value of the external test weight.
- Confirm entry with ←.
- Confirm settings with  (return to main menu).

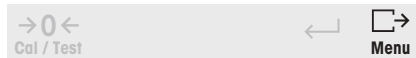
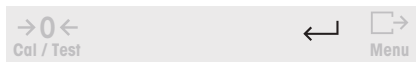

Section 2.6 describes how you test the balance.

6.3.2 Setting type of adjustment - „Adjustment“

Here you determine how the adjustment operation should be initiated, performed and recorded with your balance.

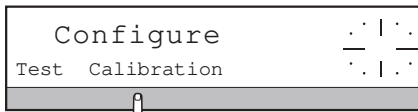

→ Select "Calibration" under "Configure".

→ Mark desired procedure.

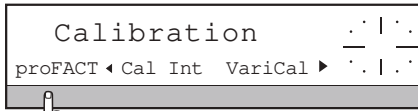

"proFACT"

In this setting (factory setting) you need not be concerned about the adjustment of your balance. As soon as the sensors installed in the balance determine an appreciable deviation since the last adjustment and the balance is currently not in use, the balance performs an automatic adjustment with the internal weight. You can also specify times when the balance automatically performs an adjustment.

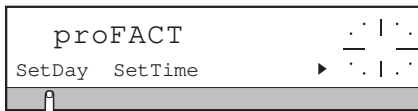

"SetDay"

Activation of the time-controlled adjustment by entry of days of the week.

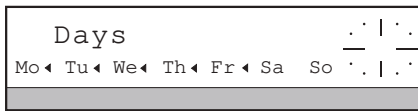

"SetTime"

Entry of the time for the time-controlled adjustment (factory setting).



"TimeTriggOnly"

Adjustment of the balance solely on the defined days at the specified time.

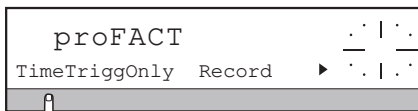

"Record"

Selection of the adjustment operations recorded when a printer is attached:

"All" All adjustment operations are recorded.

"TimeTrigg" Only the time-controlled adjustment operations are recorded (factory setting).

"Manual" Only the manual adjustment operations started by the $\rightarrow 0 \leftarrow$ _{Cal / Test} key are recorded.



Section 2.5. describes how you adjust the balance with the internal weight.

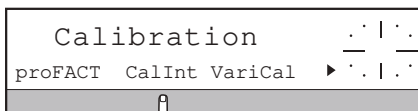

"CalInt"

With this setting you use the internal (installed in the balance) weight for the adjustment, but must initiate the procedure each time you require it using the $\rightarrow 0 \leftarrow$ _{Cal / Test} key.

"InfoOn" Display of the status message "Cal".

"InfoOff" Status message "Cal" switched off.

With certified balances, the certification regulations of your country may possibly preclude use of this setting.

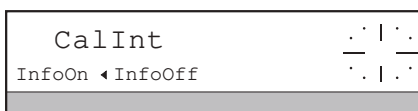

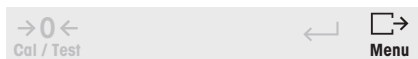
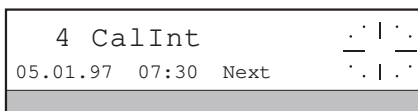
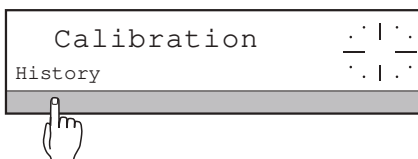
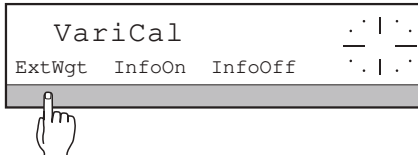
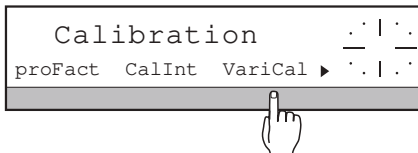

```

- CALIBRATION HISTORY --
05.01.96      09:20:25

METTLER TOLEDO
Type:         PR5002DR
SNR:          1114051374
Bal:          Your entry

1 Int  03.01.97  07:30
2 Int  04.01.97  07:30
3 Ext  04.01.97  10:15
CalExtW: 5000.00 g
4 Int  05.01.97  07:30
    
```

"VariCal"

In this setting you can use your own weights for the adjustment. The balance uses the flashing status symbol "Cal" (see section 1.5) to signal that it should be adjusted.

"InfoOn" Display of the status message "Cal".

"InfoOff" Status message "Cal" switched off.

"ExtWeights" Selection of an external weight value to adjust the balance in the vicinity of the usual load.

With certified balances, the certification regulations of your country may possibly preclude use of this setting.

Section 2.5 describes how you adjust the balance with an external weight.

"History"



Recording the last adjustment operation with time and date. In this case, the type of adjustment (internal/external) and, if applicable, the weight used are specified. With "Next" you can recall the last 50 adjustment operations.

With  all recorded adjustment operations can be printed out if a printer is attached.

6.4 Balance settings – " SYSTEM "

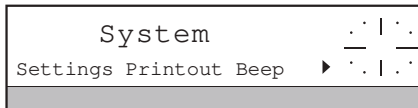
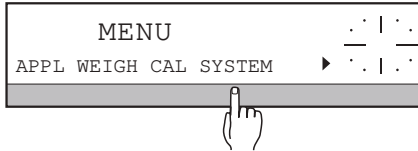
Under the menu option "SYSTEM" you mainly set the parameters concerned with documentation of the weighing results. In addition, here you can reset all adjustable parameters to the factory setting and determine the startup routine of the balance. In contrast to the settings under "WEIGH", the settings under "SYSTEM" do not influence the weighing behavior.



→ Press and hold  key until "MENU" appears in the top line of the display, if applicable enter the password "Passw= ..." and confirm with the  key.

→ Press SmartBar under "SYSTEM".

The following selection appears in the bottom line:

- "Settings" Print current settings or reset to factory settings (section 6.4.1)
- "Printout" Format header, select automatic or manual transfer of displayed results (section 6.4.2)
- "Beep" Switch acknowledgement beep on/off (section 6.4.3)
- "Date" Enter date format, call up current date (section 6.4.4)
- "Time" Enter time (24 hour format), call up (section 6.4.5)
- "BalID" Enter balance identification name, call up (section 6.4.6)
- "Icons" Switch symbols for the weighing behavior (section 1.5) on/off (see section 6.4.7)
- "StartUp" Specify startup routine (section 6.4.8)
- "PassWord" Allocate password for entry into menu (section 6.4.9)

6.4.1 Printing or resetting balance settings – " Settings "

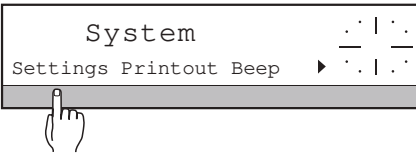

→ Select "Settings" under "System".

The following selection appears:

- "Reset" Reset settings to factory setting
- "PrintList" Store and print out current settings



Resetting settings to factory settings

→ Press SmartBar under "Reset". The following inquiry appears:

"Execute" Execute reset. All settings are reset to the factory setting with the exception of the date, time and balance identification "BallD", see section 8.2.

The balance then reports "Reset done" and returns to the weighing mode. The current total weight (gross) is displayed, "Net" fades.

"Cancel" No reset will be executed, the balance immediately returns to the selection under "System".

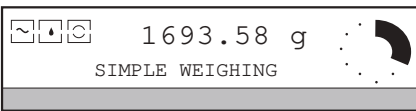
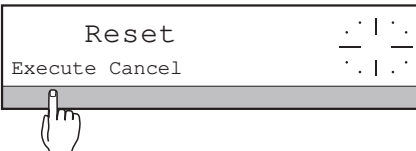

Printing out and simultaneously storing settings

→ Press SmartBar under "PrintList".

All settings in the menu are stored and printed out by the printer.

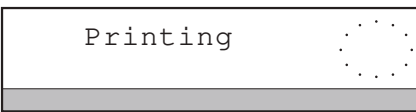

"Printing" appears in the display during printing.

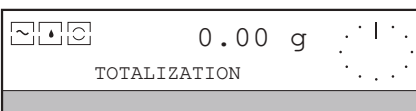

The balance then automatically returns to the weighing mode. The name of the set weighing application, e.g. "TOTALIZATION" appears in the bottom line of the display.

6.4.2 Formatting header, selecting transfer mode – " Printout "

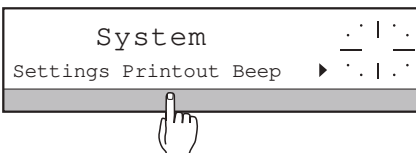

→ Select the parameter "Printout" under "System".

The following selection appears:

- "Header" Specify contents of header
- "WeightTransfer" Determine type of transfer of weighing results



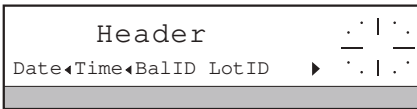

Specifying header contents – " Header "

→ Press SmartBar below "Header".

The following information can be incorporated in the header:

- "Date" Current date
- "Time" Current time
- "BallID" Balance identification (printed out together with the balance type and serial number)
- "LotID" Identification of the sample series. The actual identification is entered in the weighing mode.
- "SampleID" Identification of the individual samples in weighing (not in header printout). The actual identification is entered in the weighing mode.

→ Mark desired information with SmartBar or cancel marking of information not wanted.

→ Confirm settings with ↵.

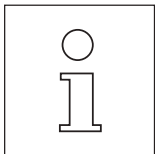
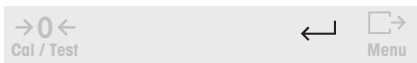

- In contrast to the entry of the date, time, etc. (see section 6.4.4), here "Header" appears in the top line of the display.
- If the lot and/or sample identification is activated, you are automatically prompted for their entry before every printout, e.g. "LID= ...".



Select transfer mode – " WeightTransfer "

→ Press SmartBar under "WeightTransfer".

→ Select desired setting.

- "Manual" The balance transfers the next stable weighing result to the recording device, e.g. a printer only after the  key has been pressed (factory setting). In weighing applications the final results of a weighing series are automatically transferred at the end of the series.
- "Auto" The balance automatically transfers all stable weighing values after taring incl. zero values as well as all results which have been received for further calculation in the weighing application (see "WeightEntry" in the applications, section 6.1).
- "AutoNoZeros" Same transfer mode as "Auto", but without displayed values less than 30 display increments (factory setting).

→ Confirm settings with ↵.

→ Press ↵ key again to return to the selection under "System".

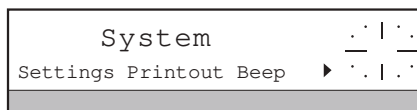
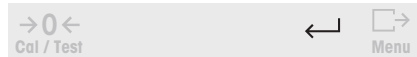
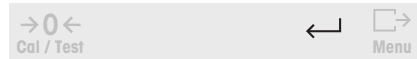

6.4.3 Switching acknowledgement beep on/off – " Beep "

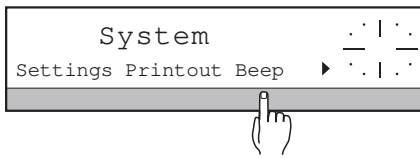

→ Select the "Beep" parameter under "System".
"Beep" appears in the top line.

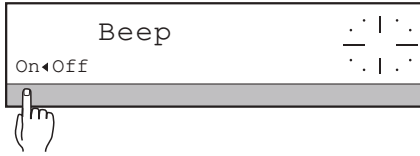

→ Mark desired setting using the SmartBar.
"On" Beep switched on (factory setting)
"Off" Beep switched off



→ Confirm setting with ←.

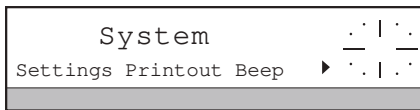

6.4.4 Entering date and date format – " Date "

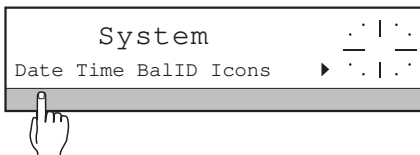

→ Select the "Date" parameter under "System".
The current date appears in the selected format in the top line.

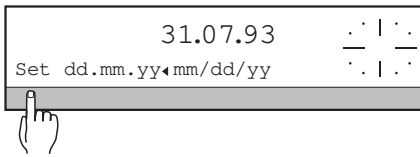

→ "Set" Enter the current date in the displayed format
"dd.mm.yy" Switch to European format: day.month.year (factory setting)
"mm/dd/yy" Switch to US format: month/day/year

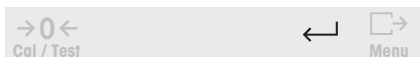

→ Confirm setting with ←.

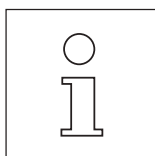

- The set date is not reset with "Reset" (all parameters to factory setting).
- The entry of preceding zeros is not mandatory. However, if you attempt to enter a number outside the date format, the message "Illegal Value" appears briefly in the top line. The display then returns to the last value.

6.4.5 Entering time – " Time "

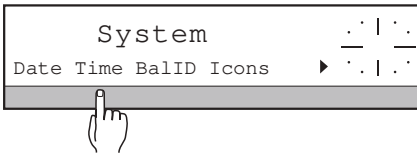

→ Select the "Time" parameter under "System".

The current time appears in the top line. The DeltaTrac changes to an analog clock.

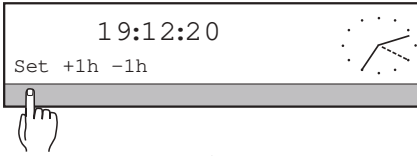

→ "Set"

Enter current time in the 24 hour format hh:mm:ss.

" +1h "

Puts the displayed time forward by one hour

" -1h "

Puts the displayed time back by one hour

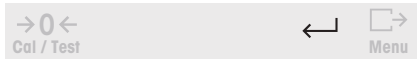

→ Confirm setting with ←.

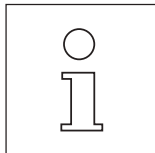
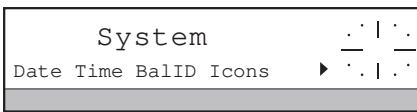

- The set time can not be reset with "Reset" (all parameters to factory setting).
- The entry of preceding zeros, minutes and seconds is not mandatory. However, if you attempt to enter a number outside the time format, the message "Illegal value" appears briefly in the top line. The display then returns to the last value.

6.4.6 Specifying balance identification – " BalID "

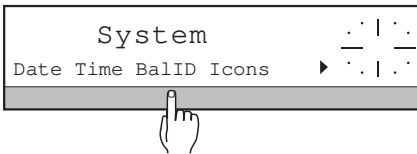

→ Select the "BalID" parameter under "System".

The current balance identification appears in the top line of the display.

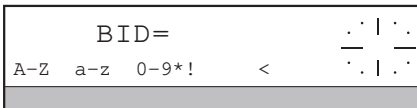

→ Enter alphanumeric balance identification. Maximum 20 characters are possible, more than 20 will not be accepted.

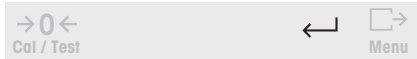

→ Confirm entry with ←.

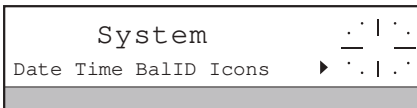

6.4.7 Switching symbols on/off – " Icons "

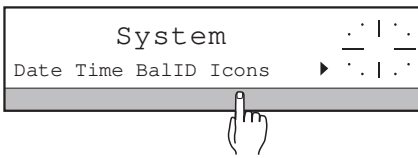

→ Select the "Icons" parameter under "System".
The symbols "☰", "☱", "☲" appear in the display.

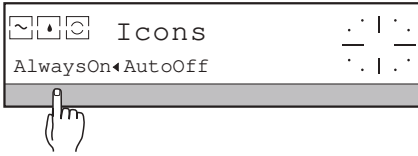

→ Mark desired behavior of the symbols with the SmartBar.
"AlwaysOn" The settings of the appropriate weighing parameters under "WEIGH" are always visible in the display (factory setting).

"AutoOff" The symbols are displayed only for around 40 seconds after the balance has been switched on or following a change in the menu settings.

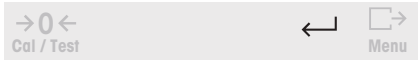

→ Confirm setting with ←.

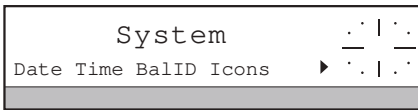

6.4.8 Specifying startup routine of the balance – " Startup "

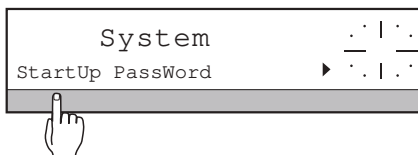

→ Select the "Startup" parameter under "System".



→ Effect desired setting.

"Full" After the balance has been switched on with the **On_{Off}** key, it performs a display test. It is not ready for operation until zero appears. Further, the switch-on zero is redetermined.

"QuickStart" The balance is immediately ready for operation
- when the **On_{Off}** key is pressed, or
- when a weight of at least 10 g is placed on the pan. In this case, the total weight is shown immediately (factory setting).

"Auto" After a power failure, the balance switches itself on automatically and is ready for operation following the display test. At the same time, the switch-on zero is determined.

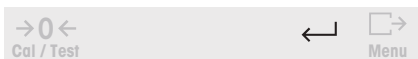

→ Confirm setting with ←.

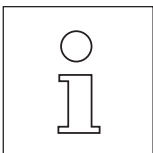
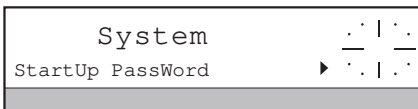

- If you have selected "Full" or "QuickStart" for the startup routine, the balance performs an extended display test following a power failure. "OFF" then appears in the display to show you that the balance was temporarily without power. When the balance is switched on from the "OFF" status, the software version numbers are displayed briefly (see section 8.1) and the switch-on zero is redefined. The balance is then ready for operation. Certified balances also perform a fully automatic adjustment if there is no weight on the pan.
- With certified balance models, the "QuickStart" setting is not possible.
- If you have attached your balance to a computer. e.g. via the LC-RS9 cable, the balance is always ready for operation after a power failure (no "OFF" status).

6.4.9 Allocating password for entry into menu – " PassWord "

With the entry of a password for entry into the menu you can protect the menu settings of your balance against changes by unauthorized persons.

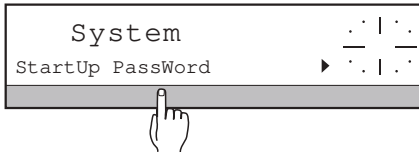

→ Select the parameter "PassWord" under "System". The selection "Define Clear" appears in the display.

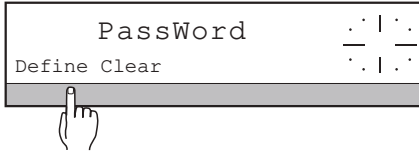

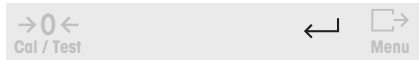
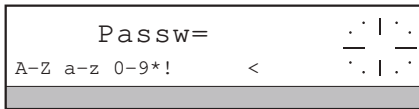

→ Set desired option.
 "Define" Enter alphanumeric password or change existing password. Maximum 20 characters are possible, additional characters will not be accepted.
 "Clear" Delete password to allow unrestricted entry into the menu.

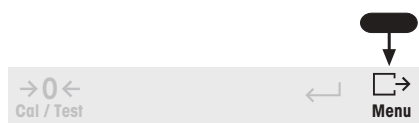

→ Confirm entry with ↵. To be on the safe side, enter password here together with the serial number of the balance (see model plate).

Passw=
 SNR:



→ Secure settings by pressing and holding the  key.
 If a password has been allocated, it must always be entered before entry into the menu. The main menu does not appear in the display until the entry has been confirmed with ↵.

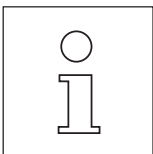

Should you forget the password, it is always possible to enter the word "CLEAR" or number "505" instead of the password to enter the menu. You can then call up the valid password under "PassWord".



6.5 Setting the language – " LANGUAGE "

The key words for the user guidance of your PR/SR balance can be displayed in various languages.

Your national language is set in the factory.

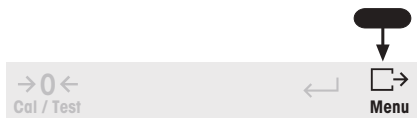
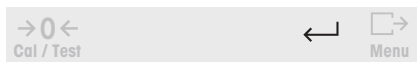
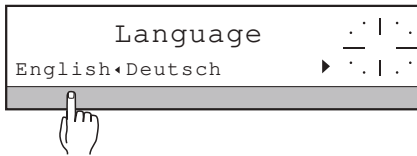
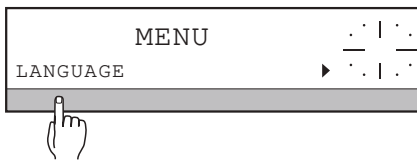
To ensure that you find this parameter in the menu in every language, the word "LANGUAGE" is used for all languages.



→ Press and hold the  key until "MENU" appears in the top line of the display, enter password "Passw= ..." if necessary and confirm with the  key.

→ Press SmartBar under "LANGUAGE".

The bottom line shows the following selection:

"English"	
"Deutsch"	German
"Français"	French
"Español"	Spanish
"Italiano"	Italian
"Russ."	Russian
"Nihongo"	Japanese

→ Select desired language.

The language marked by "♦" is immediately activated, i.e. all key words in the SmartBar line will be immediately displayed in the selected language.

→ Confirm language setting with  (return to main menu)

or

→ Press and hold  key until "Stored" appears in the top line of the display (message depends on language). Then release key, the balance returns to the weight display. The language setting is now stored. It will not be reset with "Reset" (all parameters to factory setting).

7 LocalCAN universal interface, technical data and optional equipment

7.1 LocalCAN universal interface

Every PR/SR balance is fitted with the LocalCAN universal interface as standard. As you can attach up to five peripherals at the same time, it offers you a high degree of flexibility in data interchange.

Peripherals from METTLER TOLEDO (see section 7.3) can be attached to the balance in a simple manner, the connection cables are included in the standard equipment.

With an appropriate cable (see section 7.3), you can also attach your printer or computer via an RS232C interface to the PR/SR balance.

PR/SR balances support the standardized command set "Standard Interface Command Set (MT-SICS)". The reference manual (705184) that you receive with the LC-RS or LC-CL cable describes the functions of these commands in an easily surveyed manner.

The features of the LocalCAN universal interface can be summarized as follows:

- Simultaneous attachment of up to five peripherals to a balance.
- Support of standard interfaces such as RS232C or CL.
- Rugged 4-pin connector with reverse voltage and pullout protection.
- Reliable data transfer thanks to built-in CAN controller.
- Open cabling system, i.e. every peripheral except for displays and the LC-R terminal has a second connection.
- Simple configuration of the parameters without the need to know how to operate the operating the PR/SR balance.

The versatile features of the PR/SR balances regarding documentation of the results can be used to the full only if a printer is attached, e.g. the LC-P43 from METTLER TOLEDO. The printed results make a decisive contribution to a simple working method in conformance with GLP/GMP.

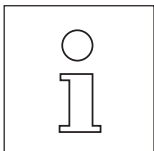

You can use one of the LC-RS cables, e.g. LC-RS25 to attach devices to your balance which can only process a weight value (with weighing unit). In this case, the left switch of the LC-RS cable is set to position 5 ("General I/O") (see operating instructions of the cable). A stable weighing result or, with dynamic weighing, the next weight result is transferred by briefly pressing the  key. No other data can be transferred in this case.

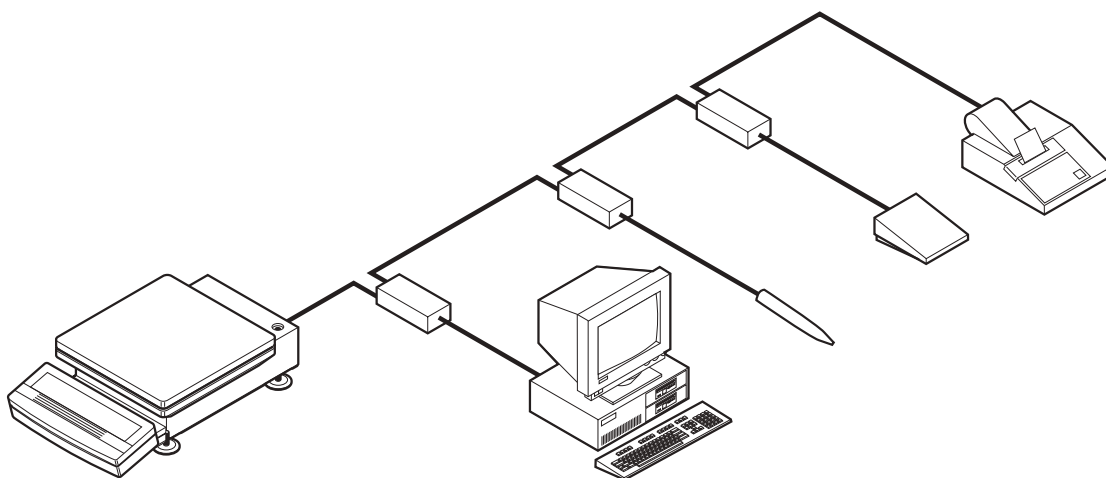

Technical data of the LocalCAN universal interface

- Cable length between two devices maximum 10 m
- Sum of the cable lengths of all attached devices maximum 15 m

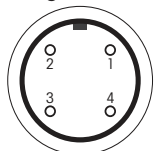
Pin assignment

Rear view of instrument

Pin No.**Signal**

1	negative signal line (-CAN)
2	positive signal line (+CAN)
3	PIplus pin of power supply (V CAN) for peripherals, e.g. auxiliary display LC-AD
4	minus pin of power supply (0 V) for peripherals

7.2 Technical data of the PR/SR balances**7.2.1 Technical data for available models**

Technical data	PR203	PR503	PR503 DeltaRange	PR803	PR1203	PR2003 DeltaRange
Readability	0.001 g	0.001 g	0.001 g/0.01 g	0.001 g	0.001 g	0.001 g/0.01 g
Max. capacity	210 g	510 g	100 g/510 g	810 g	1210 g	500 g/2100 g
Taring range (by subtraction)	0...210 g	0...510 g	0...510 g	0...810 g	0...1210 g	0...2100 g
Repeatability (s)	0.0005 g	0.0005 g	0.0005 g/0.003 g	0.001 g	0.001 g	0.001 g/0.003 g
Linearity ¹⁾	±0.002 g	±0.002 g	±0.002 g/±0.005 g	±0.002 g	±0.002 g	±0.002 g/±0.005 g
Stabilization time (typical)	1...2.5 s	1...2.5 s	1...2 s	3...5 s	3...5 s	3...6 s
Calibration with internal weight with external weights (recommended value)	Fully automatic and/or time-controlled self-calibration proFACT, manual initiation possible; test possibility for check on the sensitivity					
	≥ 100 g	≥ 200 g	≥ 200 g	≥ 400 g	≥ 500 g	≥ 500 g
Sensitivity						
Temperature drift ^{1) 2)}	±5 ppm/°C	±3 ppm/°C	±3 ppm/°C	±2 ppm/°C	±2 ppm/°C	±2.5 ppm/°C
Long-term stability ^{1) 3)}	±0.0025 %	±0.0015 %	±0.0015 %	±0.001 %	±0.001 %	±0.001 %
Size of weighing pan	128 mm x 128 mm					
All-purpose draft shield (glass) standard	standard					
Free height above pan	137 mm					
Dimensions (w x d x h)	200 mm x 385 mm x 234 mm (incl. terminal)					
Net weight	6.4 kg					
Power supply	separate	separate	separate	separate	separate	separate

¹⁾ In the temperature range 10 ... 30 °C

²⁾ 1 ppm = 1/1 000 000 (referred to the current weight display)

³⁾ Sensitivity deviation/year after first-time startup with self-calibration proFACT switched on

Technical data	PR5003 DualRange	PR802	PR2002
Readability	0.001 g/0.01 g	0.01 g	0.01 g
Max. capacity	1010 g/5100 g	810 g	2100 g
Taring (by subtraction)	0...1010 g/ 0... 5100 g	0...810 g	0...2100 g
Repeatability (s)	0.001 g/ 0.005 g	0.005 g	0.005 g
Linearity ¹⁾	±0.003 g/ ±0.01 g	±0.01 g	±0.02 g
Stabilization time (typical)	5...12 s	1...2 s	1...2 s
Calibration with internal weight with external weights (recommended value)	Fully automatic and/or time-controlled self-calibration proFACT, manual initiation possible; test possibility for check on the sensitivity ≥ 1000 g	≥ 400 g	≥ 1000 g
Sensitivity Temperature drift ^{1) 2)} Long-term stability ^{1) 3)}	±1.0 ppm/°C ±0.0015 %	±6 ppm/°C ±0.005 %	±5 ppm/°C ±0.0025 %
Size of weighing pan	128 x 128 mm	165 x 165 mm	
All-purpose draft shield (glass) or high glass draft shield	optional standard	optional optional	optional optional
Dimensions (w x d x h)	200 x 385 x 370 mm	200 x 385 x 90 mm (incl. terminal)	
Net weight	9.1 kg	6.3 kg	6.3 kg
Power supply	separate	separate	separate

¹⁾ In the temperature range 10 ... 30 °C

²⁾ 1 ppm = 1/1 000 000 (referred to the current weight display)

³⁾ Sensitivity deviation/year after first-time startup with self-calibration proFACT switched on

Technical data	PR5002	PR5002 DeltaRange	PR8002	PR8002 DeltaRange
Readability	0.01 g	0.01 g/0.1 g	0.1 g	0.01 g/0.1 g
Max. capacity	5100 g	1000 g/5100 g	8100 g	1600 g/8100 g
Taring (by subtraction)	0...5100 g	0...5100 g	0...8100 g	0...8100 g
Repeatability (s)	0.005 g	0.005 g/0.03 g	0.01 g	0.01 g/0.03 g
Linearity ¹⁾	±0.02 g	±0.02 g/ ±0.05 g	±0.02 g	±0.02 g/ ±0.05 g
Stabilization time (typical)	1...2 s	1...2 s	3...5 s	3...5 s
Calibration with internal weight with external weights (recommended value)	Fully automatic and/or time-controlled self-calibration proFACT, manual initiation possible; test possibility for check on the sensitivity			
	≥ 2000 g	≥ 2000 g	≥ 4000 g	≥ 2000 g
Sensitivity				
Temperature drift ^{1) 2)}	±3 ppm/°C	±3 ppm/°C	±2.5 ppm/°C	±2.5 ppm/°C
Long-term stability ^{1) 3)}	±0.0015 %	±0.0015 %	±0.0015 %	±0.0015 %
Size of weighing pan	165 x 165 mm			
All-purpose draft shield (glass) or high glass draft shield	optional optional			
Dimensions (w x d x h)	200 x 385 x 90 mm (incl. terminal)			
Net weight	6.3 kg	6.3 kg	5.7 kg	5.7 kg
Power supply	separate	separate	separate	separate

¹⁾ In the temperature range 10 ... 30 °C

²⁾ 1 ppm = 1/1 000 000 (referred to the current weight display)

³⁾ Sensitivity deviation/year after first-time startup with self-calibration proFACT switched on

Technical data	PR2004 Comparator	PR2003 Comparator	PR5003 Comparator	PR10003 Comparator
Readability	0.1 mg	1 mg	1 mg	1 mg
Max. capacity	2300 g	2100 g	5100 g	10100 g
Taring (by subtraction)	0...2300 g	0...2100 g	0...5100 g	0...10100 g
Repeatability	0.3 mg Standard deviation of 10 weighings (after elimination of drift)	1 mg	1.5 mg	2 mg
Linearity	±0.5 mg	±3 mg	±5 mg	±10 mg
Stabilization time (typical)	15 s	4...8 s	12...18 s	14...20 s
Calibration with internal weight with external weights	Fully automatic and/or time-controlled self-calibration proFACT, test possibility for check on the sensitivity			
	≥ 500 g	≥ 500 g	≥ 2000 g	≥ 4000 g
Sensitivity Temperature drift ^{1) 2)}	±1 ppm/°C	±2.5 ppm/°C	±1 ppm/°C	±1 ppm/°C
Weighing pan LevelMatic® pan (for automatic centering of the load)	dia. 150 mm Standard	128 x 128 mm Optional (Order no. 225675)	dia. 150 mm Standard	dia. 150 mm Standard
Free space above weighing pan	240 mm	265 mm	240 mm	240 mm
Display	VFD (vacuum fluorescent display)			
Draft shield	Glass			
Below-the-balance weighing	Opening available			
Data Interface	LocalCAN Universal Data Interface (Supporting both RS232C and CL)			
Dimensions (w x d x h)	200 x 385 x 370 mm			
Net weight	9.5 kg	9.1 kg	9.5 kg	9.5 kg

¹⁾ In the temperature range 10 ... 30 °C

²⁾ 1 ppm = 1/1 000 000 (referred to the current weight display)

Technical data	PR3001	PR5001	PR8001	PR8000
Readability	0.1 g	0.1 g	0.1 g	1 g
Max. capacity	3100 g	5100 g	8100 g	8100 g
Taring (by subtraction)	0...3100 g	0...5100 g	0...8100 g	0...8100 g
Repeatability (s)	0.05 g	0.05 g	0.05 g	0.3 g
Linearity ¹⁾	±0.1 g	±0.1 g	±0.1 g	±0.5 g
Stabilization time (typical)	1...2 s	1...2 s	1...2 s	1...2 s
Calibration with internal weight with external weights (recommended value)	Fully automatic and/or time-controlled self-calibration proFACT, manual initiation possible; test possibility for check on the sensitivity			
	≥ 2000 g	≥ 2000 g	≥ 4000 g	≥ 4000 g
Sensitivity				
Temperature drift ^{1) 2)}	±10 ppm/°C	±10 ppm/°C	±10 ppm/°C	±10 ppm/°C
Long-term stability ^{1) 3)}	±0.005 %	±0.005 %	±0.005 %	±0.005 %
Size of weighing pan (mm)	204 x 204 ⁴⁾	204 x 204	204 x 204	204 x 204
All-purpose draft shield (glass)	– ⁴⁾	–	–	–
Dimensions (w x d x h)	204 x 385 x 90 mm (incl. terminal)			
Net weight	6.2 kg	6.1 kg	6.1 kg	6.1 kg
Power supply	built-in			

¹⁾ In the temperature range 10 ... 30 °C

²⁾ 1 ppm = 1/1 000 000 (referred to the current weight display)

³⁾ Sensitivity deviation/year after first-time startup with self-calibration proFACT switched on

⁴⁾ PR with 0.1 g readability in certified version: weighing pan 165 x 165 mm, optional draft shield possible

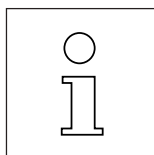

With the exception of the dimensions, the same technical data apply for R balances (PR balances without terminal).

Technical data	SR8001	SR16001	SR32001	SR16001 DeltaRange
Readability	0.1 g	0.1 g	0.1 g	0.1 g/1 g
Max. capacity	8100 g	16100 g	32100 g	3200 g/16100 g
Taring range (by subtraction)	0...8100 g	0...16100 g	0...32100 g	0...16100 g
Repeatability (s)	0.05 g	0.05 g	0.1 g	0.05 g/0.3 g
Linearity ¹⁾	±0.2 g	±0.2 g	±0.2 g ⁵⁾	±0.2 g/±0.5 g
Stabilization time (typical) ⁵⁾	1...2 s	1...3 s	1...3 s	1...3 s
Calibration with internal weight with external weights (recommended value)	Fully automatic and/or time-controlled self-calibration proFACT, manual initiation possible; test possibility for check on the sensitivity			
	≥ 4000 g	≥ 8000 g	≥ 8000 g	≥ 8000 g
Preload max ⁴⁾	10 kg	2 kg	0.3 kg	2 kg
Sensitivity				
Temperature drift ^{1) 2)}	±6 ppm/°C	±6 ppm/°C	±5 ppm/°C	±6 ppm/°C
Long-term stability ^{1) 3)}	±0.005 %	±0.003 %	±0.0015 %	±0.003 %
Dimensions (w x d x h)				
Platform	360 x 280 x 130 mm, weight: 12.7 kg			
Terminal	205 x 125 x 50 mm (for fastening on longer or shorter side of platform)			

Technical data	SR32001 DeltaRange	SR16000	SR32000
Readability	0.1 g/1 g	1 g	1 g
Max. capacity	6400 g/32100 g	16100 g	32100 g
Taring range (by subtraction)	0...32100 g	0...16100 g	0...32100 g
Repeatability (s)	0.1 g/0.3 g	0.3 g	0.3 g
Linearity ¹⁾	±0.2 g/±0.5 g	±0.5 g	±0.5 g
Stabilization time (typical) ⁵⁾	1...3 s	1...2 s	1.5...3 s
Calibration with internal weight with external weights (recommended value)	Fully automatic and/or time-controlled self-calibration proFACT, manual initiation possible; test possibility for check on the sensitivity		
	≥ 8000 g	≥ 4000 g	≥ 8000 g
Preload max. ⁴⁾	0.3 kg	2 kg	0.3 kg
Sensitivity			
Temperature drift ^{1) 2)}	±5 ppm/°C	±10 ppm/°C	±5 ppm/°C
Long-term stability ^{1) 3)}	±0.0015 %	±0.006 %	±0.003 %
Dimensions (w x d x h)			
Platform	360 x 280 x 130 mm, weight: 12.7 kg		
Terminal	205 x 125 x 50 mm (for fastening on longer or shorter side of platform)		

¹⁾ In the temperature range 10 ... 30 °C

²⁾ 1 ppm = 1/1 000 000 (referred to the current weight display)

³⁾ Sensitivity deviation/year after first-time startup with self-calibration proFACT switched on

⁴⁾ Admissible load when balance switched on without loss of weighing range

⁵⁾ Typical value

Technical data	SR64001	SR64001 DeltaRange	SR64000
Readability	0.1 g	0.1 g/1 g	1 g
Max. capacity	64100 g	12800 g/64100 g	64100 g
Taring range (by subtraction)	0...64100 g	0...64100 g	0...64100 g
Repeatability (s)	0.1 g	0.1 g/0.3 g	0.3 g
Linearity ¹⁾	±0.3 g	±0.3 g/±0.5 g	±0.5 g
Stabilization time (typical) ⁵⁾	2...4 s	2...4 s	2...4 s
Calibration with internal weight with external weights (recommended value)	Fully automatic and/or time-controlled self-calibration proFACT, manual initiation possible; test possibility for check on the sensitivity		
	≥ 20000 g	≥ 20000 g	≥ 20000 g
Preload max. ⁴⁾	0.5 kg	0.5 kg	0.5 kg
Sensitivity			
Temperature drift ^{1) 2)}	±3 ppm/°C	±3 ppm/°C	±3 ppm/°C
Long-term stability ^{1) 3)}	±0.002 %	±0.002 %	±0.002 %
Dimensions (w x d x h)			
Platform	360 x 280 x 130 mm, weight: 14.7 kg		
Terminal	205 x 125 x 50 mm (for fastening on longer or shorter side of platform)		

¹⁾ In the temperature range 10 ... 30 °C

²⁾ 1 ppm = 1/1 000 000 (referred to the current weight display)

³⁾ Sensitivity deviation/year after first-time startup with self-calibration proFACT switched on

⁴⁾ Admissible load when balance switched on without loss of weighing range

⁵⁾ Typical value

7.2.2 Dimension drawings

Dimension drawing PR balances with readability 1 mg

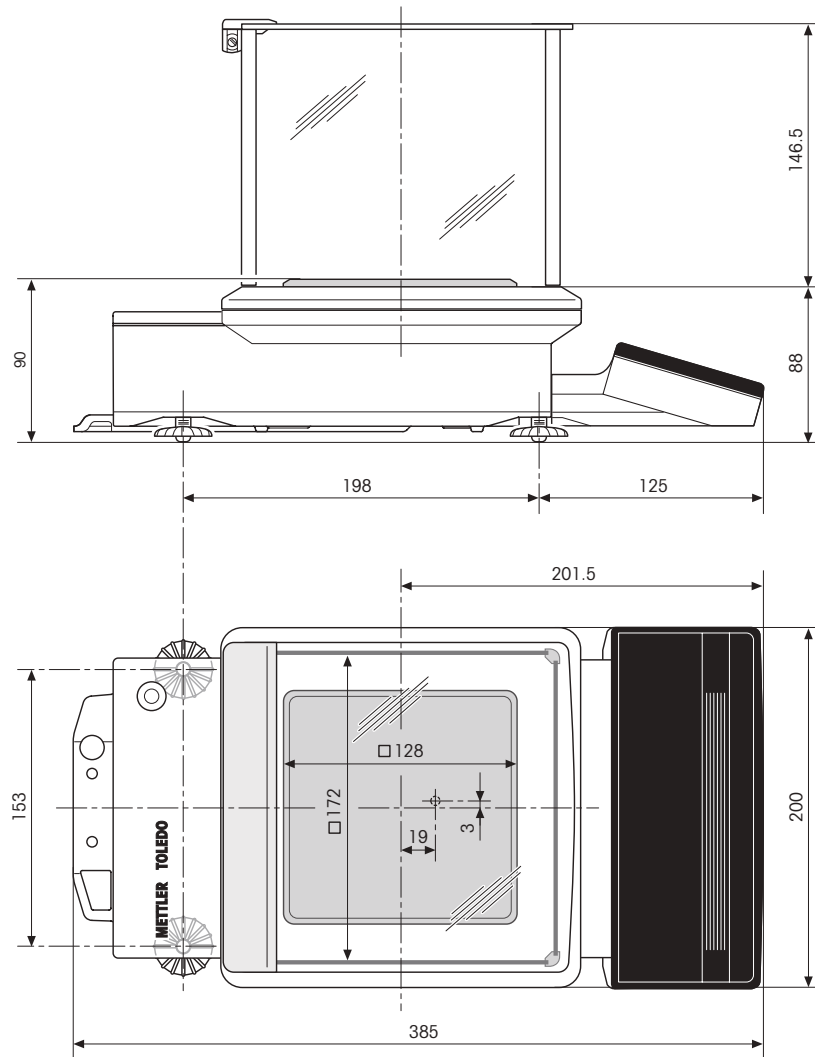

Dimension drawing PR balances with readability 10 mg and 0.1 g certified version

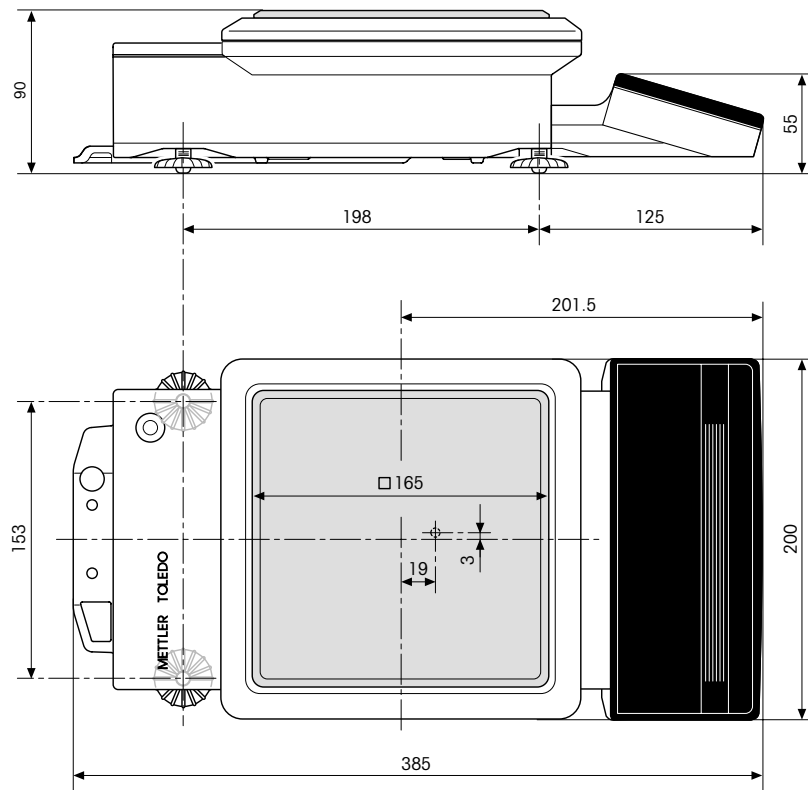

Dimension drawing PR balances with readability 0.1 g and 1 g

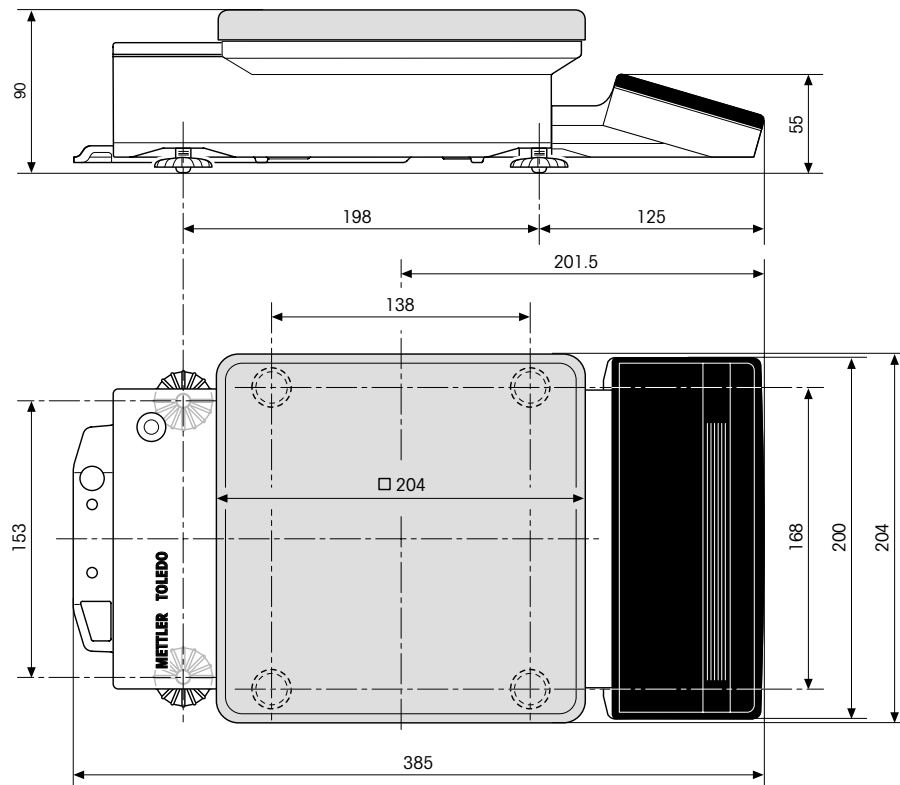

Dimension drawing SR balances

Standard equipment

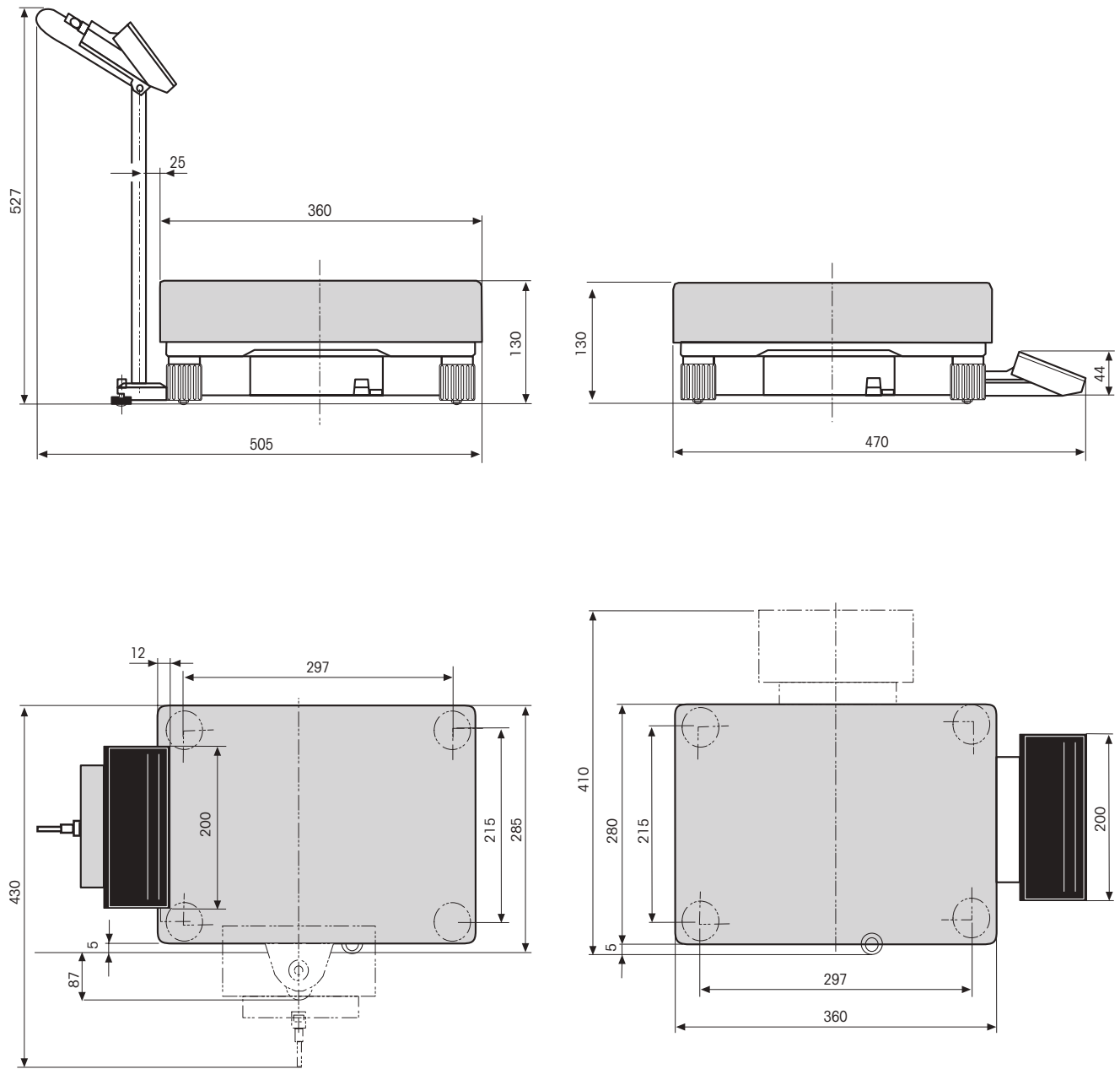

7.2.3 General technical data

Mains supply connection PR balances

Built-in power supply unit	100–240V,	–15%+10%,	50/60Hz,	350mA	
Separate AC adapter	115V,	–20%+15%,	50/60Hz,	195mA,	Sek: 12V, 50/60Hz, 1.25A
or	230V,	–20%+15%,	50/60Hz,	90mA,	Sek: 12V, 50/60Hz, 1.25A

Mains supply PR balances without power supply unit

Mains supply	9.5–17.5V,	50/60Hz,	10VA
or	9–20V=		7W

Fuse PR balances

Built-in power supply unit	T630L250V
Separate AC adapter	Temperature switch

Power supply connection SR balances

Built-in power supply unit	100–240V,	–15%+10%,	50/60Hz,	350mA
----------------------------	-----------	-----------	----------	-------

Fuse SR balances

Built-in power supply unit	T1L250V (2x)
----------------------------	--------------

Admissible ambient conditions

height above sea level	up to 4000m
temperature range	5°C to 40°C
atmospheric humidity,	80° rh at +30°C
installation category	II
pollution degree	2

Use PR/SR balances only in closed rooms

Standard equipment

- Operating instructions and short-form operating instructions
- LocalCAN universal interface
- Protective cover for terminal
- Protective cover for balance housing, PR balances only
- Feedthrough for weighing below the balance, PR balances only
- Fixture for anti-theft device
- Fixture for stand fastening
- Transport arrestment (only for balances with readability 1 mg)
- AC adapter with power cable (only for balances with separate power supply unit)

7.3 Optional equipment

			Art. No.
Printer with normal paper	• Printer for recording the results	LC-P43 printer	229114
Terminal	• Terminal for S platform or for remote control of PR, connection via LocalCAN (order cable separately)	LC-R terminal	239273
Auxiliary displays	• Auxiliary display, active, with bench stand	LC-AD	229140
	• Auxiliary display, active, with balance stand for PR	LC-ADS	229150
	• Auxiliary display, passive, (LCD) with bench stand	LC-PD	229100
	• Auxiliary display, passive, (LCD) with balance stand for PR	LC-PDS	229070
Foot switch	• Foot switch with adjustable functions	LC-FS	229060
Input/output module	• Module with digital inputs and outputs	LC-IO	21200805

			Art. No.
Cables	• Cable for attachment of a printer or computer with RS232C, 25-pin (m/f), such as IBM-XT and compatibles, incl. reference manual for MT-SICS commands	LC-RS25	229050
	• Cable for attachment of a computer with RS232C, 9-pin, such as IBM-AT and compatibles, incl. reference manual for MT-SICS commands	LC-RS9	229065
	• Cable for attachment of a device with METTLER CL interface (5-pin), incl. reference manual for MT-SICS commands	LC-CL	229130
Extension cables	• Extension cable for LocalCAN, 0.3 m	LC-LC03	239270
	• Extension cable for LocalCAN, 1 m	LC-LC1	229161
	• Extension cable for LocalCAN, 2 m	LC-LC2	229115
	• Extension cable for LocalCAN, 5 m	LC-LC5	229116
	• T-piece for LocalCAN	LC-LCT	229118
Anti-theft devices	• Metal bolt as bench feedthrough, for PR		229175
	• Steel cable with lock, for PR or SR		590101
Protective covers	• Protective cover for keypad terminal for PR (2)		225266
	• Protective cover for keypad terminal for SR (2)		239305
	• Protective cover for balance housing for PR balances with 1 mg/10 mg readability (2)		225267
	• Protective cover for balance housing for PR balances with 0.1 g/1 g readability (2)		225268
Draft shields	• All-purpose draft shield (free height 135 mm) for PR balances with 1 mg/10 mg readability		225269
	• High glass draft shield with 3 sliding doors (free height 265 mm) for PR balances with 1 mg/10 mg readability		225500
Stand	• Stand for LC-R terminal, suitable for S platforms, incl. cable	S stand	239268
Wall fixture	• Wall fixture for LC-R terminal, incl. 2 m cable		239278
Below-the-balance weighing device	• Below-the-balance weighing device for SR and S platforms		230034
Transport cases	• For PR balances without draft shield and for LC-P4x printer		225217
Density kit	• Set for the density determination of solids for PR balances with 1 mg readability		225600
	• Sinkers for the density determination of liquids (order together with density kit Art. No. 225600)		210260
Calibration weights	• Available as OIML weights (E1, E2, F2 with certification) or as calibration weights (not OIML) 50 g, 100 g, 200 g, 500 g, 1000 g, 2000 g, 2 x 2000 g, 5000 g 10000 g		on request

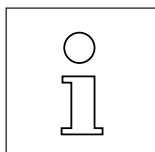

Operating or installation instructions are provided for many options. For further information or for ordering optional equipment, contact your METTLER TOLEDO dealer.

8 Appendix

8.1 Inquiry of software version numbers

Specification of the software version numbers will speed up the handling of your service inquiry.

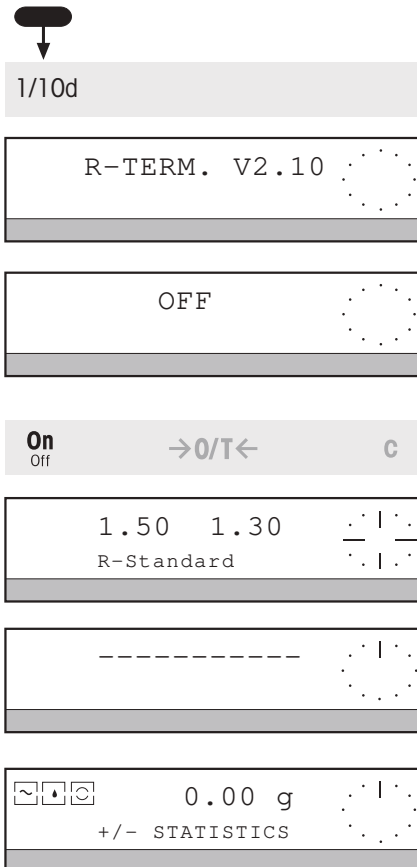

→ Disconnect power plug of balance.

Inquiry of terminal software version number

- Press and hold **1/10d** key and plug in power plug.
The terminal version number "R-TERM. V..." appears in the display.
- Release **1/10d** key, "OFF" appears in the display.

Inquiry of balance software version number

- After inquiry of the terminal version number, switch on balance with the **On_{Off}** key.
The balance software version numbers appear briefly in the display. The individual groups of the software version number have the following meaning:

left group	e.g. 1.50	Version of operating system OS (in firmware)
right group	e.g. 1.30	Version of the program cassette (interchangeable)
bottom line	e.g. R-Standard	Name of the program cassette

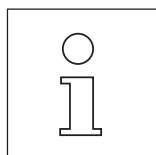
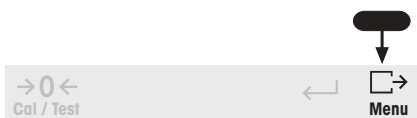

You can also print out the software version numbers using the menu function "Settings – Printout" without having to disconnect the balance from the power supply, see section 6.4.1.

8.2 Parameter settings and admissible values

Note

Several parameter values are given in display increments. One display increment corresponds to the readability of the balance, with DeltaRange balances to the readability in the fine range.

Example

100 display increments with PR5002 DeltaRange correspond to 100×0.01 g, i.e. 1.00 g.

8.2.1 Factory settings of the adjustment parameters

Parameter in weighing	Factory setting	Your setting
Dynamic WeighTime	3 s	
Count (piece counting)		
Fix	Fix10	
Var	Ref = 50	
PcWgt (piece weight)	PW = 0	
Tot (weight totalization)		
n (Max n)	n = 0 (Max n not specified)	
+/-Stats (+/- statistics)		
Weight display	Abs (absolute weight value)	
n (Max n)	n = 0 (Max n not specified)	
Nominal	Nom = 0	
-Tol	2.5 % of nominal (0)	
+Tol	2.5 % of nominal (0)	
Results	Mean value display	
Formula (Formulation)		
Target weight	Trg = 0 (No target weight)	
SampleID	No identification	

Adjustment parameter in MENU	Factory setting	Your setting
APPL	Application	None (SIMPLE WEIGHING)
	Dynamic	
	Start	Manual
	Min Weight	MW = 100 display increments
	Tot, +/- Stats	
	Mode	Single
	WeightEntry	Manual
	MinChange	MCh = 100 display increments
	+/- % (with +/- statistics)	+/- % not selected
WEIGH	Vibr (Vibrations)	Medium <input type="checkbox"/>
	Process (WghProcess)	Normal <input type="checkbox"/>
	Repro (ReproSet)	Good <input type="checkbox"/>
	Unit1 ¹⁾	g
	Unit2 ¹⁾	g
	CustomUnit	Inactive
	Factor	F = 1
	DecPlaces	DP = 2
	Name	[C]
	¹ /x	not selected
	AutoZero	On
	PreTare	Off
CAL	Calibration	proFACT (automatic and/or time-controlled self-adjustment)
	Test	Internal (with internal weight)
SYSTEM	Printout	
	Header	No header printout
	WeightTransfer	AutoNoZeros
	Beep	On
	Date	dd.mm.yy (European format)
	Icons	AlwaysOn
	StartUp ¹⁾	QuickStart
	PassWord	No password

¹⁾ Certified balance models may have other settings owing to the certification regulations.

8.2.2 Admissible ranges of the adjustment parameters

Parameter	Admissible range	Comments
BallID	BID = max. 20 characters	Additional characters are ignored
Character selection	"A -Z" "a - z" (each 26 letters) "0 - 9" "+" "-" "*" "/" "=" "?" "!" ":" ";" "." and space (shown by □)	
Date (dd.mm.yy)	dd = 1 ... 31, mm = 1 ... 12, yy = 0 ... 99	mm/dd/yy format is also possible
DecPlaces	DP = 0 ... 7	Depending on the readability of the balance, the displayed decimal places remain at zero
Ext. weight for test	EW = 100 display increments ... max. load	
Factor	F = ± 0 ... 100 000	Large factor "F" can lead to overflow of the display "*****" when "CustomUnit" is used. Negative Factor with simple weighing only!
Fix	Fix = 1 ... 1 000	
LotID	LID = max. 20 characters	Additional characters are ignored
MinChange	MCh = 1 display increment ... max. load	MCh has the same value as MW
MinWeight	MW = 1 display increment ... max. load	MW has the same value as MCh
n (Max n entry)	n = 0 ... 999	No entry with n = 0
Nominal (+/- Stats)	Nom = 0 ... max. load	No ± display with Nom = 0
PcWgt (manual entry)	PW = 0 ... max. load	No display in "PCS" with PW = 0
PcWgt (weighed)	PW = 1 display increment ... max. load	
PreTare	PT = 0 ... max. load	
SampleID	SID = max. 20 characters	Additional characters are ignored
-Tol	-T = 0 ... max. load or 0 ... 100 %	Tolerance in % when +/-% activated in the menu
+Tol	+T = 0 ... max. load or 0 ... 100 %	
Target weight (formulation)	Trg = 0 ... max. load	No ± display with Trg = 0
Time (hh:mm:ss)	hh = 0 ... 23, mm = 0 ... 59, ss = 0 ... 59	Entry of only hh or hh:mm possible
Var	Ref = 1 ... number of display increments	Number of display increments = max. load/display increment

8.2.3 Admissible ranges of the zeroing and taring functions

Function	Admissible range with certified version	Admissible range with normal version
Zeroing → 0 ← After zeroing applies: Net = Gross = 0, Tare = 0	up to ±2 % of the maximum capacity	over the entire weighing range
Taring → T ←	over the entire weighing range	over the entire weighing range

8.2.4 Selection of the weights for calibration (adjustment)

Balance model	Possible values of the external weights (in grams) ¹⁾
PR203	50, 100, 150, 200
PR503, PR503DR, PR502	200, 300, 400, 500
PR803, PR802	400, 500 , 600, 700, 800
PR1203	500, 600, 700, 800, 900, 1000 , 1100, 1200
PR2003DR, PR2002, PR2003 Comparator	500, 1000, 1500, 2000
PR3001	500, 1000, 1500, 2000 , 2500, 3000
PR5002, PR5002DR, PR5001	2000, 3000, 4000, 5000
PR5003 Comparator	2000, 3000, 4000, 5000
PR5003DU	1000 , 2000, 3000, 4000, 5000
PR8002, PR8002DR, PR8001, PR8000	(2000), 4000, 5000 , 6000, 7000, 8000
PR10003 Comparator	4000, 6000, 8000, 10000
SR8001	4000 , 6000, 8000
SR16001, SR16001DR	4000, 6000, 8000 , 10000, 12000, 14000, 16000
SR16000	4000 , 6000, 8000, 10000, 12000, 14000, 16000
SR32001, SR32001DR, SR32000	8000 , 10000, 12000, 14000, 16000, 18000, 20000, 22000, 24000, 26000, 28000, 30000, 32000
SR64001, SR64001DR, SR64000	20000 , 30000, 40000, 50000, 60000

Factory setting in **boldface**

¹⁾ With certified balance models, certification regulations may prevent the use of external weights for calibration.

8.3 Messages in the display

During operation of the balance a message or an unusual display may appear briefly in the top line of the display. There are two different types of messages: Information (type "I") or error message if operating errors occur (type "F").

Message	Type	Meaning	Remedial action
Abort	I	• Function (taring, zero setting, weight transfer, calibration, test, start in dynamic weighing, etc.) interrupted by keystroke	
Cal done	I	• Calibration (adjustment) completed successfully	
Illegal value	F	• Inputted value or value calculated in piece counting "Count" outside admissible range, old value remains unchanged	• Effect entry in admissible region (section 8.2.2)
InitCal done	I	• Adjustment of internal calibration (adjustment) finished	• Wait for following calibration with internal weight
MinChng-Err	F	• Weight can not be transferred as the load change since the last weight transfer has not attained the "MinChange" value (see appropriate application, section 6.1)	• Induce load change by displacement of the weighing pan
no Prog	I	• Program cassette missing or not inserted properly	• Insert program cassette (properly) (section 8.7)
No reference	F	• No piece weight or target weight available (see piece counting and +/-statistics, section 5)	• Enter piece or target weight
Not allowed	F	• On zeroing of certified balances: Zeroing is allowed only up to ± 2 % of the weighing range.	• Unload balance or reduce load
n = Max n	I	• Specified number of samples (n=...) reached, after unloading of the balance the weighing series is automatically closed and the results cleared	• To close, unload balance; to determine additional samples, increase Max n or set it to zero
n > 0 -> Clear	I	• Weighing series in progress (item counter > 0), entry into the menu or alteration of the reference or switching between units in +/-statistics not allowed	• First close weighing series with "Clear"
PassWord =	I	• Entry into MENU protected by a password	• Enter valid password
Press →0←	F	• On taring: The balance was first switched on or zeroed with load and then unloaded.	• First rezero balance after unloading
Printing	I	• A list of the settings has been sent to the printer (section 6.4.1)	
RefOpt-Err	F	• Piece count since the last piece weight determination more than doubled, reference optimization not allowed	• Reduce piece number on the balance
Reset done	I	• Resetting of the parameters to the factory setting finished	

Message	Type	Meaning	Remedial action
Stored	I	<ul style="list-style-type: none"> All settings stored on exit from menu 	
Timeout	F	<ul style="list-style-type: none"> Function (taring, zero setting, weight transfer, calibration, test) aborted as the balance was not stable for a certain period or the required weight for calibration or test was not placed on the pan 	<ul style="list-style-type: none"> Check balance location (section 2.2) or place required weight, if requested, on pan
Wrong OS (after switching on)	F	<ul style="list-style-type: none"> Program cassette not compatible with operating system of the balance 	<ul style="list-style-type: none"> Call METTLER TOLEDO dealer or service
Wrong term. (after switching on)	F	<ul style="list-style-type: none"> Program of the keypad terminal not compatible with the program cassette. 	<ul style="list-style-type: none"> Call METTLER TOLEDO dealer or service
-----7	F	<ul style="list-style-type: none"> Balance overloaded, if active printer prints "I+" 	<ul style="list-style-type: none"> Reduce weight
-----1	F	<ul style="list-style-type: none"> Load too small, if active printer prints "I-" Balance faulty 	<ul style="list-style-type: none"> Mount weighing pan support and weighing pan Have balance repaired
Flashing of a weight value	I	<ul style="list-style-type: none"> Balance requests the set weight for the calibration (adjustment) or the test 	<ul style="list-style-type: none"> Place weight whose value flashes on pan
Flashing of the zero value	I	<ul style="list-style-type: none"> Balance requests that it be unloaded Load on switching on too great (with certified balances) Balance faulty 	<ul style="list-style-type: none"> Unload balance Unload balance Have balance repaired
"*****"	F	<ul style="list-style-type: none"> Overflow of the display as multiplication factor "F" selected for "CustomUnit" too large 	<ul style="list-style-type: none"> Reduce multiplication factor or weight
Weight display does not react		<ul style="list-style-type: none"> One of the fixed results (e.g. tare weight) is displayed (watch for status symbol "T", "*", etc.) Balance faulty 	<ul style="list-style-type: none"> Set desired display via "Results" Have balance repaired

8.4 Adjustment of the internal calibration

Together with the fully automatic and/or time-controlled self-calibration (adjustment) proFACT, with noncertified versions of the PR/SR balances you can choose to configure the internal calibration (adjustment) to your weight standard if a test of the balance with this reference weight shows that the deviation is larger than that specified in the technical data (see section 7.2.2 under "Long-term stability of the sensitivity"). The better the following requirements are met, the more exactly can be internal calibration (adjustment) be adjusted.

Requirements

- The balance is leveled (section 2.3).
- The balance has been connected to the power supply for at least 4 hours.
- There are no excessive drafts at the balance location, use draft shield if necessary.
- No excessive temperature fluctuations are present (see section 2.2).
- You have one of the selectable weights available (see section 8.2.4) with the greatest possible accuracy.

Important

Before you start the adjustment

- Ensure that you have taken the deviation of your weight standard from the nominal value into account in the determination of the sensitivity deviation.
- Note that the balance only takes into consideration the nominal value of your weight in the adjustment, e.g. 5000.00 g and not the actual value, e.g. 5000.013 g.

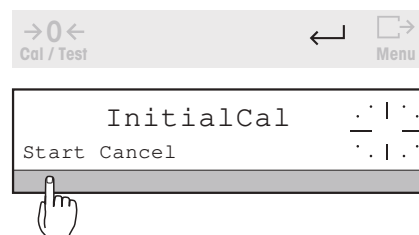
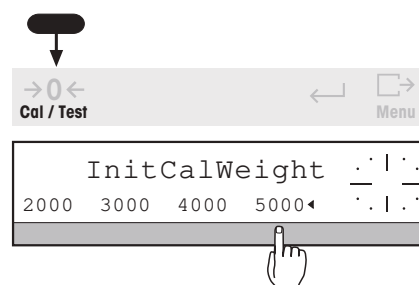
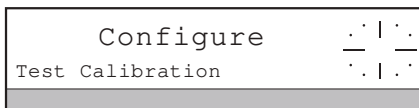
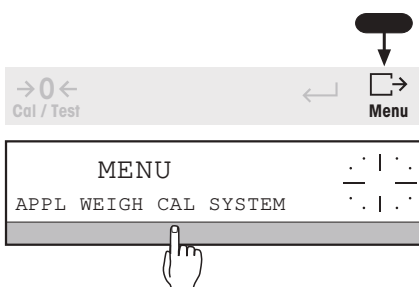

Adjustment of the internal calibration

→ Press and hold  key until "MENU" appears, if applicable enter the valid password.

→ Press SmartBar under "CAL".

→ Press and hold  key until "InitCalWeight" appears in the top line of the display.

→ Select appropriate weight value.

→ Confirm selection with  key.

→ Press SmartBar under "Start" to start the adjustment; press SmartBar under "Cancel" to abort.



"- INITIAL CALIBRATION" appears in the bottom line of the display. Shortly after the start, the selected weight value flashes in the display.
 → Place weight in center of weighing pan.



→ When zero flashes, remove weight.



When "InitCal done" appears in the display, the first phase of the adjustment is at an end. If a printer is attached, the procedure is recorded. The balance then automatically performs the second phase, which corresponds to a calibration (adjustment) with an internal weight. If a printer is attached, this phase is also recorded.

The adjustment is not at an end until both phases have been successfully completed!

If the second phase has not been completed correctly, an internal calibration (adjustment) must be performed before work can be started with the balance.

```

- INITIAL CALIBRATION --
17.06.95      14:51:15
METTLER TOLEDO
Type:        PR5002DR
SNR:         1114051374
Bal:         Your entry

Weight ID:.....

Weight:      5000.00g

Initial calibration done

Signature:

.....
----- END -----
    
```

```

- BALANCE CALIBRATION --
17.06.95      14:52:31
METTLER TOLEDO
Type:        PR5002DR
SNR:         1114051374
Bal:         Your entry

Int. calibration done

Signature:

.....
----- END -----
    
```

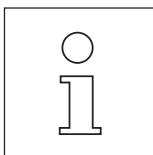

- The maintenance of your balance by a trained service engineer for METTLER TOLEDO products includes an extensive check and if need be additional adjustment procedures. You should thus not forget regular maintenance.
- For the service, weights traceable to your national weight standards are always used and are checked at regular intervals (recalibration). It is thus possible to assure unrestricted functioning and accuracy of your balance by maintenance.

8.5 Maintenance

Servicing

Regular maintenance of your balance by an authorized service engineer ensures years of invariable accuracy and increases its service life. Ask your METTLER TOLEDO dealer for details of service possibilities.

PR balances

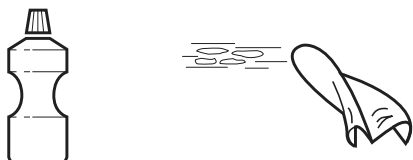

Cleaning

The balance housing and the weighing pan are made of high-grade, resistant materials. All commercial cleaning agents can thus be used.

- PR balances can best be cleaned with a damp cloth.
- SR balances have an increased degree of protection of the housing. With the weighing pan mounted, they may be rinsed under running water ensuring that the power plug never becomes wet.

With the weighing pan removed, the SR balance may be cleaned with a damp cloth.

SR balances

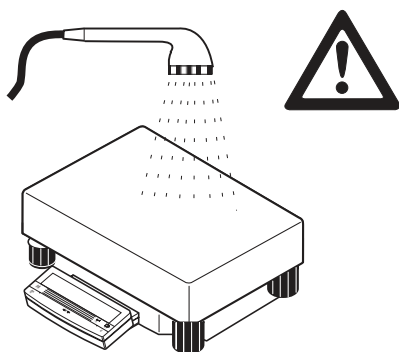

Cautionary note

Before spraying, the balance must be unplugged from the power supply, i.e. disconnect power plug.

Protective covers

Soiled protective covers can be changed for all balance types, see Optional equipment in section 7.3.

Battery

After approx. 3 - 4 years, the battery in the program cassette must be changed, see section 8.7.

Attention

If you have to dispose of the instrument, contact your METTLER TOLEDO agency.

8.6 Changing the fuse (only with balances with built-in power supply unit)



Cautionary note

Before replacing the fuses, unplug balance from power supply, i.e. disconnect power plug!

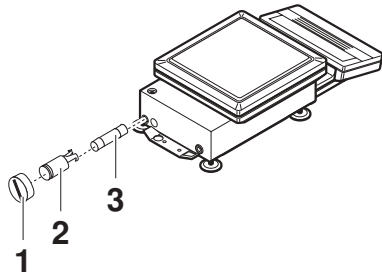

PR balances

- Unscrew cap (1) at rear of balance.
- Unscrew fuse insert (2) using a screwdriver counterclockwise.
- Replace fuse (3) by a new fuse of the same rating and type:
0.63 A slow-blow, IEC 127-2.
- Insert fuse insert (2) into the holder and lock into place by turning clockwise, screw cap (1) back on.
- Level balance (section 2.3).

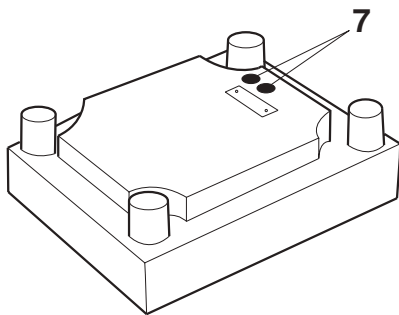

SR balances

- Turn balance with weighing pan over and rest on weighing pan.
- Remove the two plastic covers (7).
- Unscrew fuse inserts (2) using a screwdriver counterclockwise.
- Replace fuses (3) by new fuses of the same rating and type:
1 A slow-blow, IEC 127-2.
- Insert fuse inserts (2) into the holder and lock into place by turning clockwise, press on plastic cover (7).
- Return balance to weighing position and level (section 2.3).

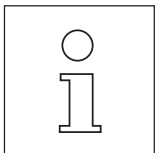

- If the new fuses blow again within a short space of time, there is a fault in the power supply of the balance. Please disconnect the balance from the power supply and have the instrument repaired by a authorized service engineer. On no account attempt to repair the balance yourself.
- PR balances with separate AC adapter do not have a fuse.

8.7 Changing the battery



Cautionary note

Before replacing the battery, unplug balance from power supply, i.e. disconnect power plug!

Caution

When replacing the battery type CR2032, 3 volts, some of the parameter values of the weighing applications are lost. When the balance is restarted, the customer's settings, especially date, time, balance identification, password as well as numeric entries such as "MinWeight", "Nominal", etc. must be reentered and saved.

- Before replacing the battery, if need be print out settings on an attached printer with the "PrintList" function (section 6.4.1) and/or enter in the column "Your setting" in section 8.2.1.
- Ensure environmentally compatible disposal of used batteries.

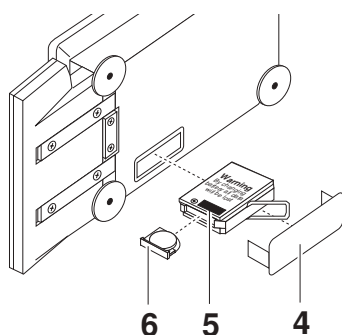

PR balances

- Remove weighing pan and if mounted draft shield or draft shield element and weighing pan support and tilt balance on its left side.
- Remove cover (4).
- Take out battery cassette (5) using clip.
- Remove holder (6) with old battery from cassette.
- Insert new battery, push holder back into cassette.
- Insert cassette, mount cover.
- Position balance upright in normal position, mount weighing pan support, draft shield or draft shield element and weighing pan.
- Level balance (section 2.3).

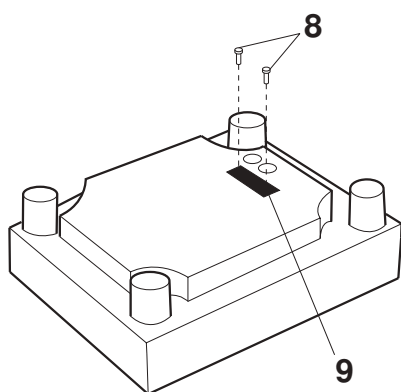

SR balances

- Turn balance with weighing pan over so that the bottom of the balance faces upward.
- Unscrew screws (8) and remove cover (9).
- Take out battery cassette (5) using clip.
- Remove holder (6) with old battery from cassette.
- Insert new battery, push holder back into cassette.
- Insert cassette, screw on cover with seal facing inside of balance.
- Move balance back to weighing position and level (section 2.3).

8.8 SOP (Standard Operating Procedure)

In the documentation of a GLP test, the SOPs are a relatively small, but nonetheless important constituent.

We shall be pleased to help you in the preparation of "instrument SOPs" and ask you to contact our product managers if you need any advice.

From practical experience we know that SOPs written by users are read and followed extremely carefully by the respective employees compared with those produced by an anonymous authority, often with unfamiliar formulations.

To support your work, we recommend the following literature published or issued by METTLER TOLEDO:

- Quality assurance of measuring instruments (balances) following GLP/GMP-DIN-ISO 721189
This brochure has a whole chapter devoted to SOPs.
- GLP manual for practitioners
published by GIT-Verlag, Darmstadt, ISBN 3-928865-03-X

As a "first aid measure", we offer here an overview entitled: "Who has to do what regarding SOPs?" and a checklist for writing an SOP.

Who has to do what regarding SOPs?

Inspection and testing equipment manager	<ul style="list-style-type: none"> • orders SOPs to be written, • approves them with date and signature.
Inspection and testing director	<ul style="list-style-type: none"> • ensures that SOPs are available, • approves them on behalf of the management.
Personnel	<ul style="list-style-type: none"> • follow the SOPs and other directions.
GLP quality assurance	<ul style="list-style-type: none"> • checks whether valid SOPs are available, whether these are followed, whether and how changes are documented.

SOP checklist

Formalities	yes	no
1. Use of SOP forms		
2. Name of inspection and testing equipment		
3. Date (= date when SOP written)		
4. SOP storage identification (master reference plan)		
5. Page numbering (1 of ...)		
6. Title		
7. Date of validity (1st day of validity)		
8. Update information		
9. Specification of departments responsible for implementation		
10. Date and signatures a) author b) checker c) person responsible for authorization		
11. Distribution list		

Details of SOP contents	yes	no
1. Introduction and goal		
2. Material needed		
3. Description of work steps		
4. Description of documentation		
5. Data processing and evaluation (where applicable)		
6. Documentation, samples, etc. to be stored		
7. Archiving instructions		

8.9 Index

- Adjustment** 2.5, 6.3
 Adjustment of the
 internal calibration 8.4
 Alphanumeric entry 3.10
 Ambient conditions 2.2, 6.2, 7.2
 Anti-theft device 1.3, 2.2, 7.3
 Application 5, 6.1
 Attachment possibilities . 1.1, 7.1, 7.3
 AutoCal 2.5, 6.3
 Automatic weight transfer 5, 6.4
 AutoNoZeros 6.4
 AutoZero 6.2
 Auxiliary display 1.1, 7.3
- Balance identification** 4.1, 6.4
 BallID 4.1, 6.4
 Barcode 3.10
 Basic functions 3, 4
 Battery 8.5, 8.6
 Beep 6.4
- Cables** 7.3
 Cal 3.8, 6.4, 8.3
 Calibration 2.5, 6.3
 Cautionary notes 2.1
 Certified version 1.1, 1.6, 6.2, 6.3, 8.2,
 8.4
 Check 5.4
 Checkweighing 6.2
 Cleaning 8.5
 Configuration 6
 Control unit 1.1, 1.2, 1.3, 2.2
 Counting 5.2, 6.1
 CustomUnit 4.5, 6.2
- Data interface** 1.1, 1.3, 7.1
 Data transfer 3.7, 6.4
 Date 4.1, 6.4
 DeltaRange 1.1, 3.5, 7.2
 DeltaTrac 1.1, 1.5, 3.4, 5.4, 5.5
 Display field 1.3, 1.5
 Draft shield 1.2, 1.3, 2.2, 7.2
 Dynamic weighing 5.1, 6.1
- Extended basic functions** 4
- Factory settings** 8.2
 Fine range 1.1, 3.5, 7.2
- Foot switch
 1.1, 5.1, 5.2, 5.3, 5.4, 5.5, 7.3
 Formulation 5.5, 6.1
 Fully automatic
 self-calibration 1.1, 2.5, 6.3
 Fuse changing 8.6
- GLP** 1.1, 2.6, 6.3, 8.8
 Gross 5.6
- Header** 4.1, 4.2, 6.4
 Header printout 3.7, 4.1, 6.4
- Icons** 6.4
 Item counter 5.1, 5.3, 5.4, 5.5
- Key field** 1.3, 1.4
- Language** 6.5
 Level control 1.3, 2.3
 Leveling 2.3
 Linearity 7.2
 LocalCAN universal
 interface 1.1, 1.3, 7.1
 Long-term stability 7.2
 LotID 4.2, 6.4
- Maintenance** 8.5
 Maximum capacity 7.2
 Mean value 2.7, 5.1, 5.4
 Menu 1.4, 6
 Messages 8.3
 MinChange 5, 6, 8.2
 Minimum load change 5, 6, 8.2
 MinWeight 5, 6, 8.2
- Net** 3.3, 5.6
 Nominal weight 5.4
- Optional equipment** 7.3
- PassWord** 6.4
 Percent weighing 5.4, 6.1
 Piece counting 5.2, 6.1
 Plus/minus weighing 5.4, 6.1
 Power supply connection 2.4, 7.2
- PreTare 3.3, 4.4, 6.2
 Printer 1.1, 2.5, 7.3
 Printing 3.7, 6.4
 Printout 3.7, 4.1, 6.4
 Process 6.2
 proFACT 1.1, 2.5, 6.3
 Protective cover 7.2, 7.3, 8.3
- QuickStart** 3.1, 6.4
- Ranges (admissible)** 8.2
 Readability 3.6, 7.2
 Reference optimization 5.2
 RefOpt 5.2
 Relative standard
 deviation 2.7, 5.1, 5.4
 Repeatability 1.5, 6.2, 7.2
 Reproducibility 1.5, 2.7, 6.2
 ReproCheck 2.7
 ReproSet 1.5, 2.7, 6.2
 Reset 6.4
 Resolution 3.6, 7.2
 RS232C 1.1, 7.1, 7.3
- Sample identification**
 3.7, 4.1, 4.3, 6.4
 SampleID 4.3, 5.5, 6.4
 Sensitivity 7.2
 Series identification 4.2, 6.4
 Servicing 8.5
 SetRef 5.2
 Settings 6.4
 Signature 2.5
 Simple weighing 3.2, 6.1
 SmartBar 1.1, 1.4, 1.5, 3.9
 SOP 8.8
 Stability detector 1.5
 Stabilization time 7.2
 Stand 1.3, 7.3
 Standard deviation 2.7, 5.1, 5.4
 Standard equipment 1.2
 StartUp 6.4
 Startup procedure 2
 Startup routine 6.4
 Statistics 5.1, 5.4, 6.1
 Status displays 1.5
 Switch-on zero 6.4
 Switching off 1.4, 3.1
 Switching on 1.4, 3.1
 System 3.7, 6.4

T are weight	3.3
Target	5.5
Target weight	5.4, 5.5
Taring	1.4, 3.3, 6.2
Taring range	7.2
Technical data	7.1, 7.2
Temperature drift	7.2
Terminal	1.1, 1.2, 1.3, 2.2
Test function	2.6, 6.3
Time	4.1, 6.4
Time-controlled self-calibration	1.1, 2.5, 6.3
Tolerances	5.4
Totalization	5.3, 6.1
U nit switching	4.5
Unit1/Unit2	4.5, 6.2
V ariCal	2.5, 6.3
Vibrations	1.5, 6.2
W eighing mode	1.4, 1.5, 3, 4, 5, 6.2
Weighing pan	1.2, 1.3, 2.2, 7.2
Weight unit	4.5, 6.2
WeightEntry	5.3, 5.4, 5.5, 6.1
W eighTransfer	5.2, 5.3, 5.4, 6.4
Z ero setting	1.4, 3.3
%Weighing	5.4, 6.1
+/-Weighing	5.4, 6.1

**To protect your METTLER TOLEDO product's future:
METTLER TOLEDO service assures the quality, measuring accuracy and
preservation of value of all METTLER TOLEDO products for years to
come.**

**Please send for full details about our attractive terms of service.
Thank you.**



P11780234

Subject to technical changes.
Printed on 100 % chlorine-free paper.
For the sake of our environment.

© Mettler-Toledo GmbH 2001 11780234A Printed in Switzerland 0105/2.12

Mettler-Toledo GmbH, Laboratory & Weighing Technologies, CH-8606 Greifensee, Switzerland
Phone +41-1944 22 11, Fax +41-1-944 30 60, Internet: <http://www.mt.com>