

Operating instructions

METTLER TOLEDO

PG-S balances (0.001 g, 0.01 g)

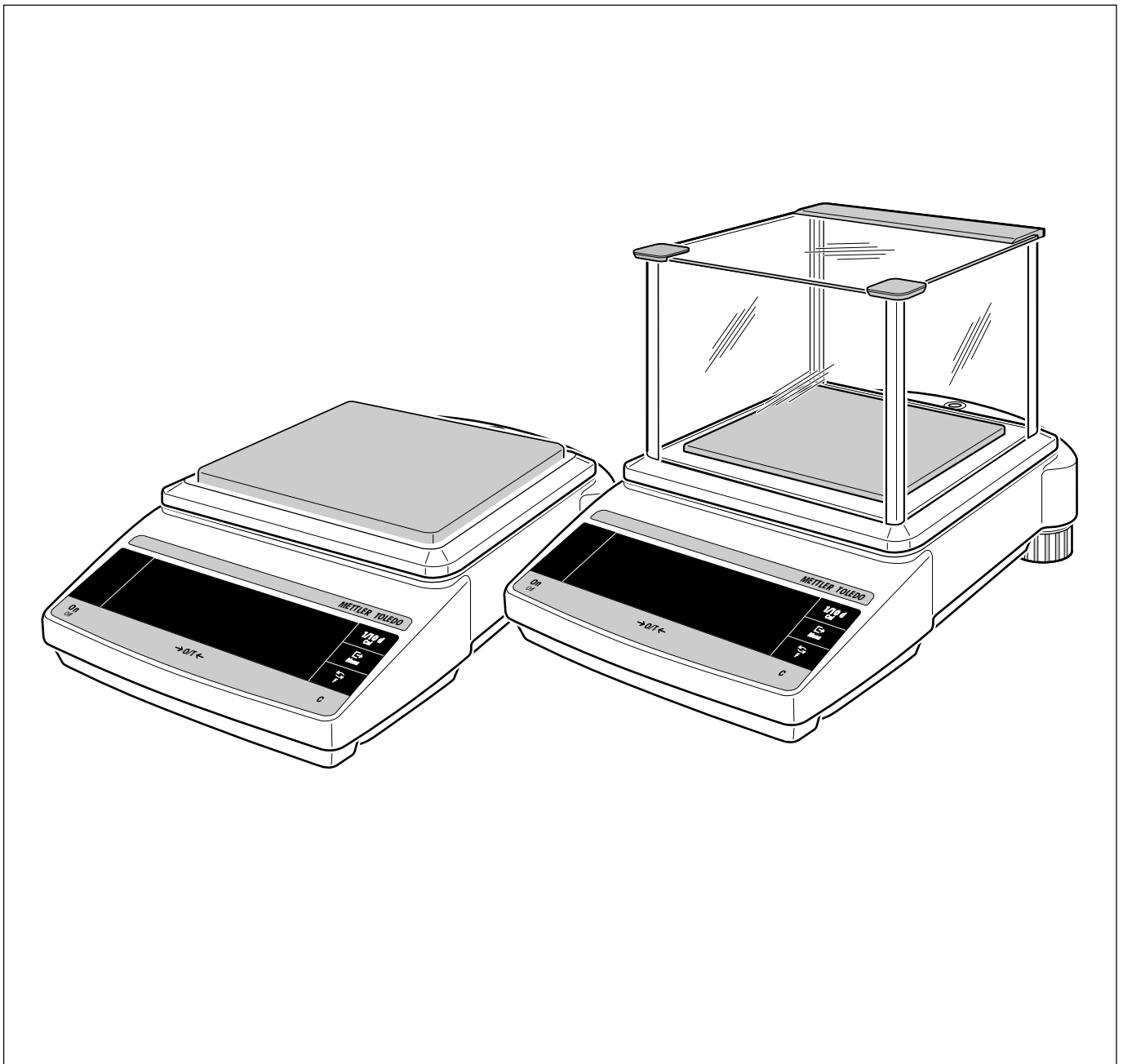

Overview of your PG-S balance

Front view PG-S

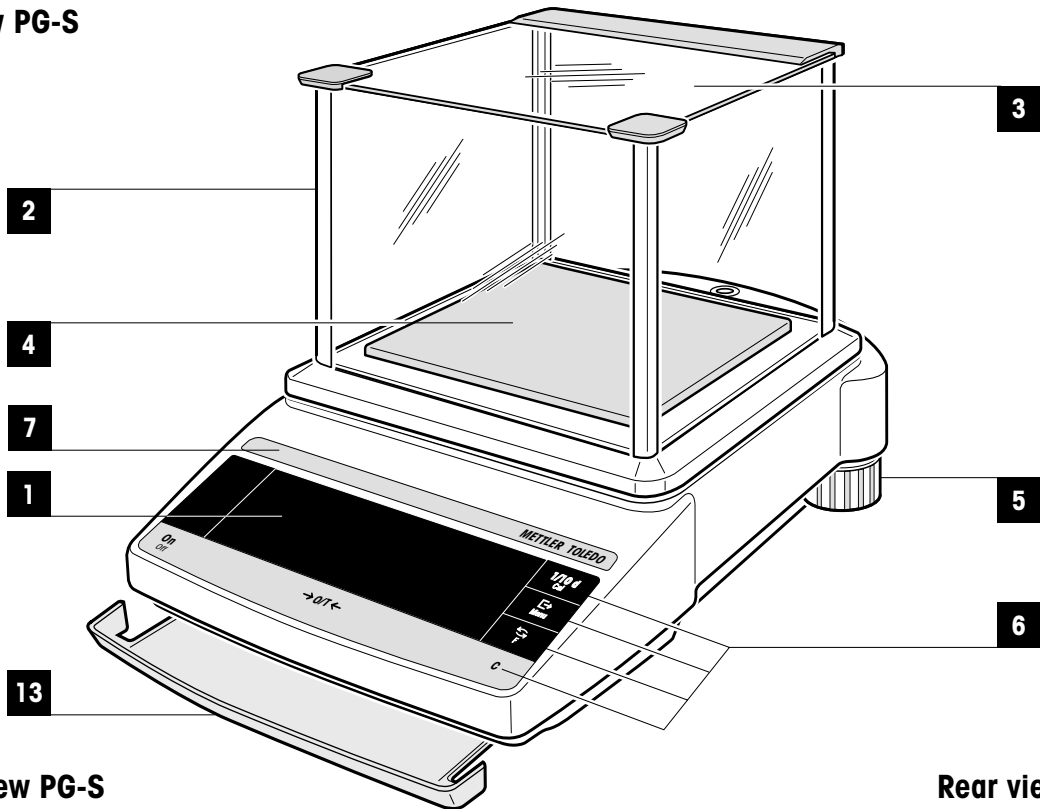

Bottom view PG-S

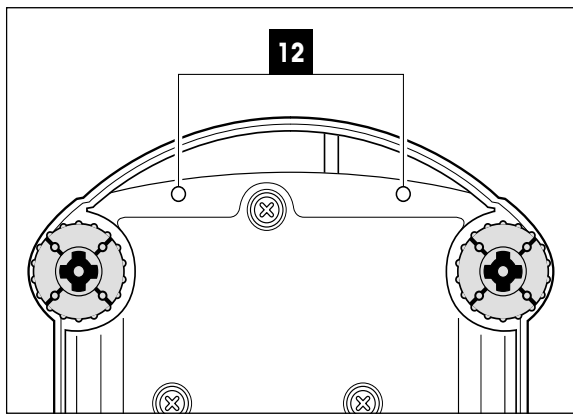

Rear view PG-S

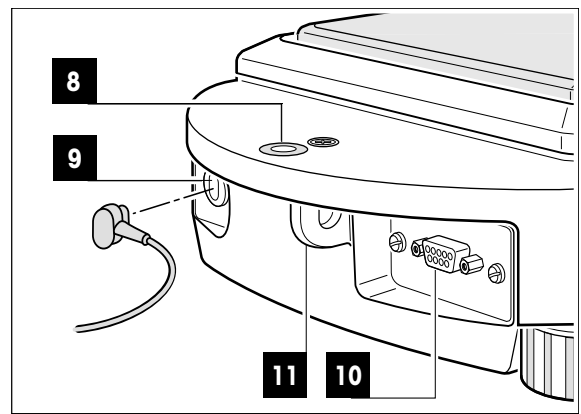

Display PG-S

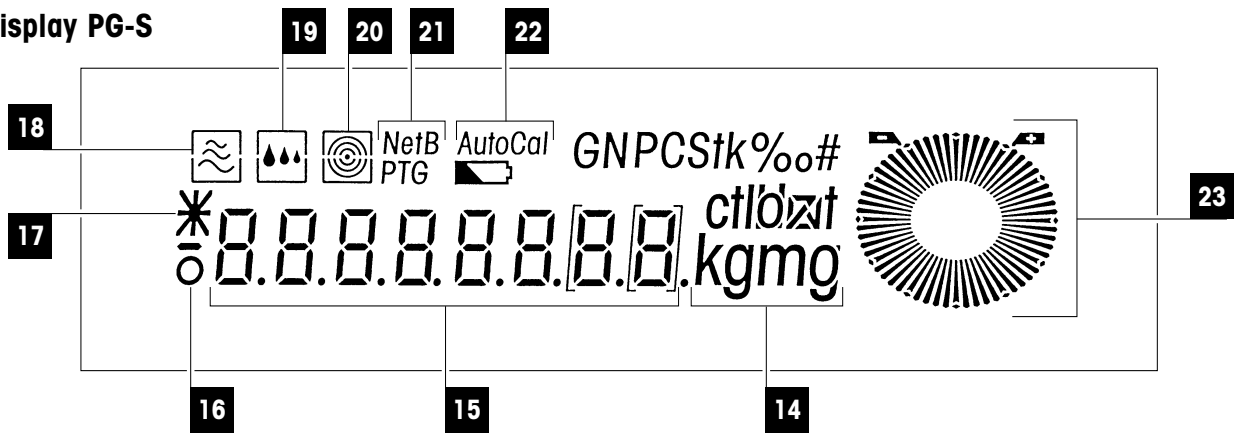

Display, controls and connections of your PG-S balance

Front view

No.	Designation
1	Display
2	Draft shield (PG-S 1 mg models only)
3	Draft shield cover
4	Weighing pan
5	Leveling foot
6	Control keys
7	Model plate with the following data: "Max": maximum capacity "d" readability "Min": minimum capacity (recommended minimum load; only relevant for certified balances) "e" verification scale interval (smallest display increment tested during certification; only relevant for certified balances)

Rear/bottom view

No.	Designation
7	Level control
8	Connection for AC adapter
9	RS232C interface connection
10	Fastening for steel wire anti-theft device
11	Fastening for auxiliary display
12	Short form operating instructions

Display

No.	Designation
13	Weighing units
14	Alphanumeric display (result, menu, etc.)
15	Symbol of the stability detector
16	Symbol for calculated result
17	Status indicator of the vibration adapter

No.	Designation
18	Status indicator of the weighing process adapter
19	Status indicator of the repeatability
20	Function displays for special applications
21	Display of adjustment mode
22	DeltaTrac

Contents

1.	Getting to know your PG-S balance	6
1.1	Introduction	6
1.2	Overview of the PG-S balances	6
1.3	What you should know about these instructions	7
1.4	Safety has priority	8
2.	Putting the balance into operation	9
2.1	Unpacking and checking the standard equipment	9
2.2	Location selection or location change	10
2.3	Leveling the balance	10
2.4	Power supply	11
2.5	Adjusting (calibrating) the balance	12
3.	Weighing made simple	13
3.1	Switching the balance on and off	13
3.2	Taring the balance	14
3.3	Performing a simple weighing	15
3.4	Weighing with the analog display – DeltaTrac	15
3.5	DeltaRange® balances with movable fine range	16
3.6	Faster weighing with lower readability	16
3.7	Switching weighing units	17
3.8	Printing out the weighing result and transferring data	17
4.	The menu	18
4.1	What is the menu?	18
4.2	Menu operation	19
4.3	Reset	21
4.4	Selection of the adjustment (calibration) and test function	21
4.5	Switching automatic adjustment call-up on or off	22
4.6	Preselecting a function	23
4.7	Setting the vibration adapter	24
4.8	Setting the weighing process adapter	24
4.9	Selecting repeatability	25
4.10	Selecting weighing unit 1	26
4.11	Selecting weighing unit 2	27
4.12	Switching automatic zero correction (Autozero) on or off	28

4.13	Preselecting automatic shutdown	28
4.14	Selecting the power-up mode	29
4.15	Setting display of the icons	30
4.16	Selecting peripheral device	30
4.17	Selecting data transfer mode	30
4.18	Selecting data transfer format	31
4.19	Setting baud rate (data transfer rate)	32
4.20	Setting parity/bit	32
4.21	Setting handshake	33
4.22	Printing out or saving menu settings	33
4.23	Canceling secure function	34
5.	Special applications and functions	35
5.1	Piece counting	35
5.2	Percent weighing	37
5.3	Formula weighing	38
5.4	Dynamic weighing of unstable weighing samples	42
5.5	Below-the-balance weighings	44
5.6	Adjustment (calibration) with internal weight	45
5.7	Adjustment (calibration) with external weights (VariCal)	47
5.8	Test of the balance with internal weight or external weights	49
6	Further important information	52
6.1	Error messages	52
6.2	Preventive maintenance and care	53
6.3	Changing the protective cover	54
6.4	RS232C interface	54
6.5	LocalCAN universal interface	55
7.	Technical data and optional equipment	56
7.1	Technical data of the PG-S balances	56
7.2	Dimensions	60
7.3	Optional equipment	62
8.	Appendix	64
8.1	Overview of menu	64
8.2	Conversion table for weight units	65
8.3	SOP (Standard Operating Procedure)	66
8.4	Index	68

1. Getting to know your PG-S balance

This section provides you with detailed information on your PG-S balance. Please read through the section carefully even if you already have experience with METTLER TOLEDO balances and scales and be sure to familiarize yourself with the safety notes!

1.1 Introduction

Thank you for deciding to purchase a balance from METTLER TOLEDO.

The precision balances of the PG-S line combine a wide range of weighing functions and setting possibilities with exceptional ease of operation.

Please read through these operating instructions thoroughly so that you can exploit all the possibilities offered by your balance to the full. As soon as you are familiar with the functions of your balance, you will find the short-form operating instructions supplied as standard useful in your daily work.

These operating instructions apply to all balances of the PG-S line with a readability in the range 0.001 g/0.01 g. However, the various models have different equipment and performance features. Where this is important for the operation, special mention is made in the text.

1.2 Overview of the PG-S balances

The PG-S balance family comprises various precision balances which differ according to their weighing range, resolution and equipment features.

The models of the PG-S line have the following features:

- Extremely rugged and chemically resistant construction.
- Convenient keypad for one-hand operation and large size, easily readable display.
- FACT (Fully Automatic Calibration Technology), fully automatic, motorized adjustment (calibration) with internal weight.
- Built-in functions for piece counting, percent weighing, formula weighing and dynamic weight determination.
- Built-in RS232C interface.
- Optional LocalCAN universal interface allows the attachment of up to 5 peripheral devices.
- Integrated short-form operating instructions to facilitate your daily work.
- Dynamic graphic indicator (DeltaTrac) for analog display of the weighing range still remaining.

A brief word regarding standards, directives and procedures for quality assurance: Your PG-S balance conforms with all common standards and directives. It supports standard procedures, handicaps, work techniques and records as required by **GLP** (**G**ood **L**aboratory **P**ractice) and **SOP** (**S**tandard **O**perating **P**rocedure). Recording of the sequences of operations and adjustment work is highly important in this connection: we recommend use of the METTLER TOLEDO LC-P45 Printer here. Your PG-S balance has a CE declaration of conformity and METTLER TOLEDO as the manufacturer has been awarded ISO 9001 certification.

Certified versions of PG-S balances are also available, please ask your nearest METTLER TOLEDO dealer.

1.3 What you should know about these instructions

These instructions contain orientation aids which facilitate your search for the desired information:

Key designations are enclosed in double angle brackets (e.g. «**On/Off**» or «**↔**»).

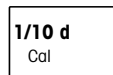

The keys of your PG-S balance have two assignments. The first function of a key (e.g. «**1/10d**») is always available by pressing the key briefly, whereas the second function (e.g. «**Cal.**») is called up by pressing and holding the key:

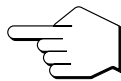

This symbol indicates a brief keystroke.

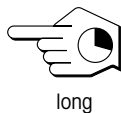

This symbol indicates a long, sustained keystroke (approx. 2 seconds).

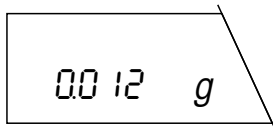

This representation symbolizes the current display of your balance.

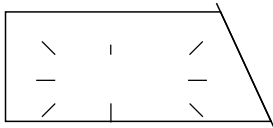

This representation symbolizes a flashing element in the display of your balance.

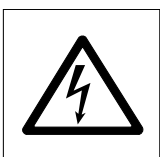

These symbols indicate safety and hazard instructions which must be complied with. Nonconformance with such instructions can lead to personal injuries to the user, damage to the balance or other tangible assets or to malfunctions.

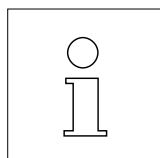

This symbol indicates additional information and instructions which facilitate your handling of the balance and contribute to proper and economical use.

1.4 Safety has priority



Please note the following instructions for safe and problem-free operation of your PG-S balance.

Read through these operating instructions carefully even if you already have experience with METTLER TOLEDO balances and scales.

It is essential to note the instructions in section 2 when putting your new balance into operation.

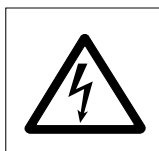

PG-S balances may be used only indoors in closed rooms.

The PG-S balances may not be operated in a hazardous environment and only when attached to receptacle outlets with a ground connection.

Use only the AC adapter supplied with your PG-S balance and ensure that the voltage value printed on it matches the local line voltage.

Operate and use your PG-S balance only in accordance with the instructions in these operating instructions and short-form operating instructions.

Use only optional equipment and peripherals supplied by METTLER TOLEDO with your PG-S balance; these have been optimally matched to your balance.

Your PG-S balance has a very rugged construction, but it is still a precision instrument. Treat it with the appropriate care and it will thank you with years of trouble-free operation.

Never operate the keypad of your PG-S balance with sharp objects!

Never open the balance, it contains no parts which can be maintained, repaired or replaced by the user. In the unlikely event you experience problems with your balance, please contact your responsible METTLER TOLEDO dealer.

2. Putting the balance into operation

In this section you will learn how you unpack and set up your new balance and prepare it for operation. On completion of the steps described in this section, your balance is ready for operation.

2.1 Unpacking and checking the standard equipment

PG-S balances are supplied in an environmentally harmless package. Please check the standard equipment of your balance for completeness:

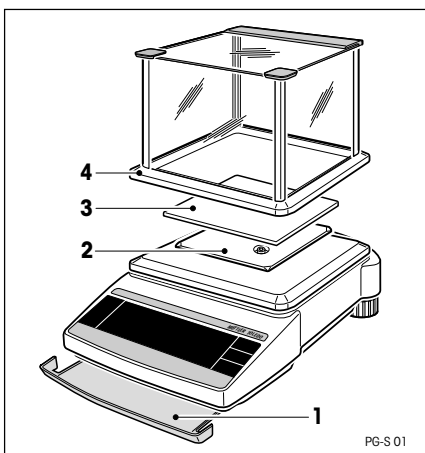

PG-S balances with readability 0.001 g

- Operating instructions
- Short-form operating instructions (1)
- Weighing pan support (2)
- Weighing pan (3)
- Draft shield (4)
- AC adapter
- Power cable
- Holder for AC adapter
- Protective cover
- Description of interface commands
(Reference manual MT-SICS, available in English only)

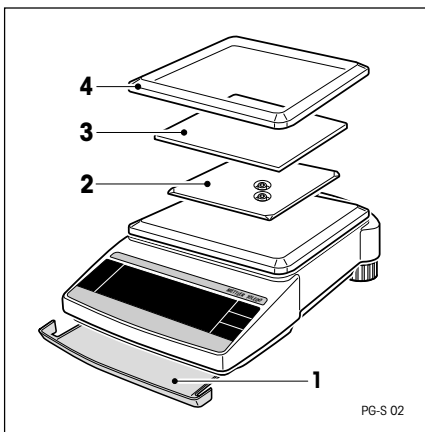

PG-S balances with readability 0.01 g

- Operating instructions
- Short-form operating instructions (1)
- Weighing pan support (2)
- Weighing pan (3)
- Draft shield element (4)
- AC adapter
- Power cable
- Holder for AC adapter
- Protective cover
- Description of interface commands
(Reference manual MT-SICS, available in English only)

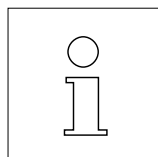

Store all parts of the packaging in a safe place. This packaging guarantees the best possible protection for the transport of your balance.

2.2 Location selection or location change

Your balance is a precision instrument and will thank you for an optimum location with high accuracy and dependability:

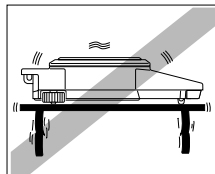

Firm, vibration-free position as horizontal as possible

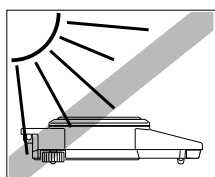

No direct sunlight

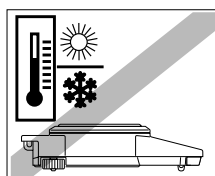

No excessive temperature fluctuations

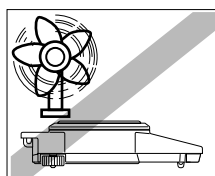

No excessive drafts (powerful air conditioning systems or fume hoods can also cause drafts).

2.3 Leveling the balance

To assure repeatable weighing results at all times, the balance must be exactly horizontal. To compensate minor unevenness at its location, the balance can be leveled:

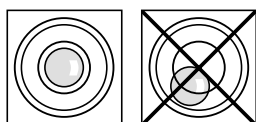

Turn the two leveling feet at the back of the balance housing until the air bubble is in the center of the level control.

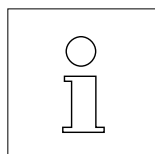

The balance must be releveled each time its location is changed.

2.4 Power supply

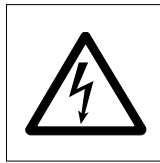

Check whether the voltage printed on the AC adapter matches your local line voltage. If this is not the case, on no account connect the AC adapter to the power supply, but contact your responsible METTLER TOLEDO dealer.

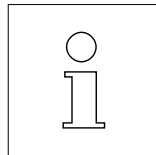

There are two different AC adapters with national power cable available for your PG-S balance:

115 V, -15% + 10%, 50/60 Hz

230 V, -15% + 10%, 50/60 Hz.

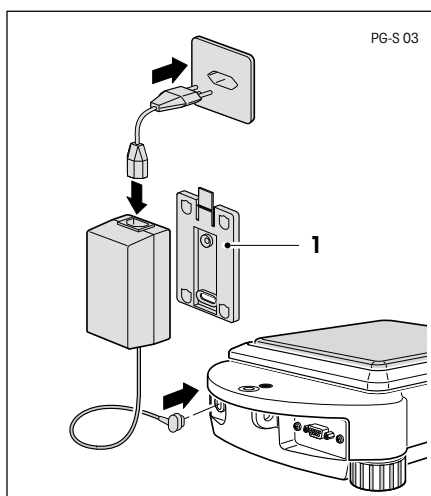

If you wish to work with the holder (1) supplied with the AC adapter: Attach the holder with two screws to a suitable, sufficiently stable area (e.g. on the wall or the underside of a bench top). Press the AC adapter into the holder.

Note:

The AC adapter can be removed from the holder by pressing the projecting lug.

Connect the AC adapter to the connection socket of your balance and to the power supply.



Ensure that the AC adapter can never come into contact with liquids!

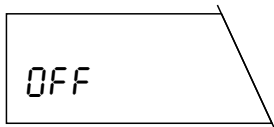

The balance now performs a self-test in which all display segments light up briefly. "OFF" then appears in the display ("OFF" indicates that the balance has been disconnected from the power supply).

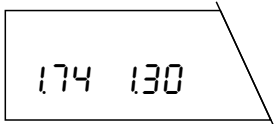
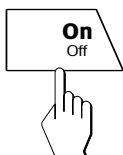

Press the «**On/Off**» key. The display briefly provides information on the installed software version and the normal weight display then appears.

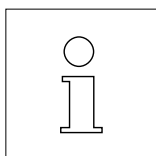

Allow your balance to warm up for 30 minutes to enable it to adapt itself to the ambient conditions.

2.5 Adjusting (calibrating) the balance

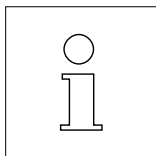

An adjustment (i.e. an adjustment to the acceleration due to gravity) is needed when putting into operation for the first time and after every location change. In colloquial language, this operation is frequently also referred to as “calibration” (to avoid misunderstandings, this term is enclosed in brackets when necessary). You should also adjust (calibrate) your balance at regular intervals in weighing operations to obtain precise results. If you work according to **GLP** (Good Laboratory Practice) and **SOP** (Standard Operating Procedure), please note the stipulated intervals for the adjustment (calibration).

With PG-S balances you have various possibilities for adjusting (calibrating) or checking the balance. You have a choice between the following parameters:

- Adjustment (calibration) or checking the balance,
- internal or external weights,
- automatic or manual initiation of the adjustment operation

The factory setting is fully automatic adjustment (calibration) FACT (Fully Automatic Calibration Technology) with the internal weight. In this setting, you have no need worry about adjusting (calibrating) your balance.

The balance adjusts itself automatically

- after the warm-up phase on connection to the power supply,
- in the case of certified balances, during the warm-up phase (after power failure),
- when a change in the ambient conditions, e.g. the temperature could lead to a noticeable deviation in the measurement.

If your balance is attached to a printer, the adjustment (calibration) is automatically printed out in conformance with GLP. The record opposite is a specimen printed out with the METTLER TOLEDO LC-P45 Printer.

```

--BALANCE  CALIBRATION--
03.10.97      11:23:34

METTLER TOLEDO
Type:         PG802-S
SNR:         1105238536
SW:          1.74 1.30

Internal cal. done

Signature:

.....
-----  END  -----
    
```

3. Weighing made simple

This section shows you how to perform simple weighings, how you can accelerate the weighing process and print out the weighing result and transfer data.

3.1 Switching the balance on and off

Your balance is set in the factory so that it automatically switches to the weighing mode when you load a weight in the standby mode.

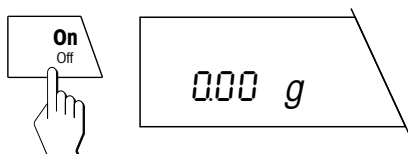

To **switch the balance on**, press the «**On/Off**» key **briefly**. As soon as the normal weight display appears, your balance is ready to weigh.

Note

In section 4.14 you will learn how to perform a display test in which all segments of the display light up briefly when you switch on the balance.

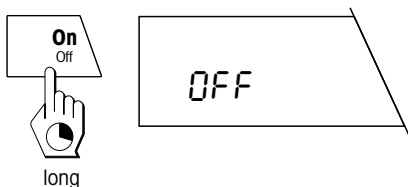

To **switch the balance off**, press the «**On/Off**» key and keep it pressed until the message "OFF" appears in the display.

After it has been switched off, your balance is in the standby mode. If you wish to perform a weighing, you need now only place the sample on the weighing pan and the balance immediately displays the result. There is no need to switch it on with the «**On/Off**» key (see also section 4.14). (This function is inoperative with certified balances.)

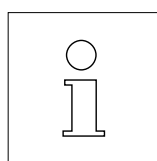

As your balance needs no warm-up time when in the standby mode and is immediately ready for weighing, we advise you to switch the instrument off only by use of the «**On/Off**» key and not to disconnect it from the power supply. This also ensures that the balance is always in thermal equilibrium.

3.2 Taring the balance

The weight of any weighing container can be “tared” at a keystroke to set the display to zero. The taring range covers the entire weighing range of your balance.

If you wish to tare a container, place it on the weighing pan.

Close all draft shield doors (if draft shield used).

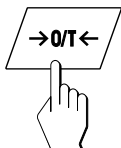

Press the «→0/T←» key **briefly** to start the taring operation.

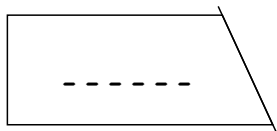

Taring runs automatically. If you tare the balance when it is unstable, the taring procedure will be shown in the display by horizontal segments.

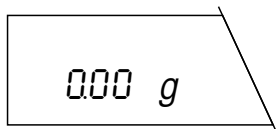

On completion of taring, the zero display appears and your balance is ready for weighing.

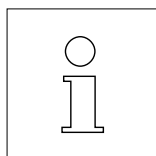

Taring can be aborted by pressing the «→0/T←» key again when the balance is in an unstable (not yet tared) condition.

3.3 Performing a simple weighing

For the sake of completeness, the following section describes how a simple weighing is performed.

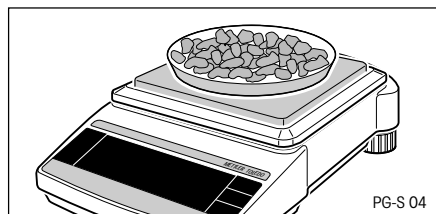

After you have tared the balance, place the weighing sample on the pan.

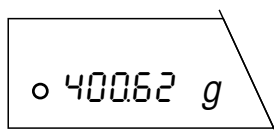

Wait until the circular symbol of the stability detector fades. Fading of the symbol indicates that the weighing result is stable.

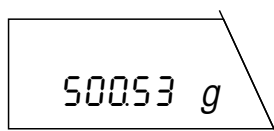

Now read off the weight in the display.

3.4 Weighing with the analog display – DeltaTrac

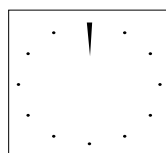

0% in use

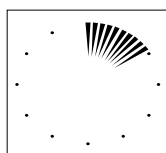

15% in use

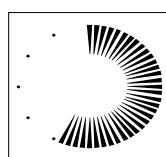

55% in use

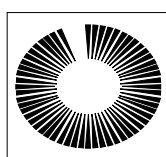

95% in use

DeltaTrac is a dynamic graphic indicator which shows the weighing range in use and that still available. You can thus recognize at a glance when the load on the balance approaches the maximum capacity.

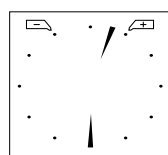

Weight within tolerance

Note

You can use the «» key to switch from the dynamic graphic indicator to a display with two pointers and two tolerance marks (for percent weighing). This enables you to determine the position of the weighing result in regard to the target weight quicker (see section 5.2). The tolerance range is $\pm 2.5\%$ of the target weight. The setting of this tolerance range is fixed and can be changed only via the interface.

3.5 DeltaRange® balances with movable fine range

METTLER TOLEDO DeltaRange® balances have a **movable** fine range with 10 times higher readability. An additional decimal place always appears in the display of this fine range. Thanks to the DeltaRange function, you have the possibility to weigh small amounts of samples into heavy weighing containers.

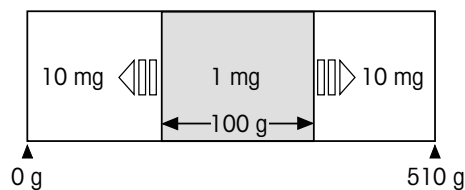

The illustration opposite shows the principle of the movable fine range in which one extra decimal place is shown (in this example, the movable fine range encompasses 100 grams).

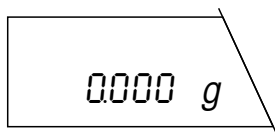

After the balance has been switched on, METTLER TOLEDO DeltaRange® balances operate in the fine range as standard.

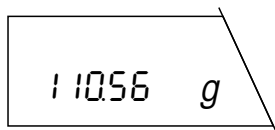

If the fine range in the display is exceeded, the balance display automatically switches to the lower readability.

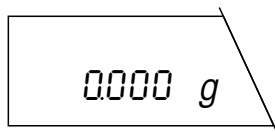
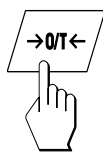

However, the fine range can always be recalled by taring the balance again.

3.6 Faster weighing with lower readability

Your balance allows you to lower the readability (number of decimal places) at any time and thus accelerate the weighing process:

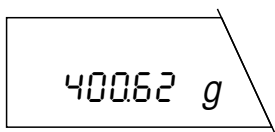

The balance is operating with **normal readability and speed**.

Note

The number of decimal places which are displayed with normal readability depends on the balance model, the weighing range and the selected weighing unit.

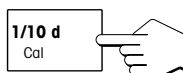

Press the «**1/10d**» key briefly and ...

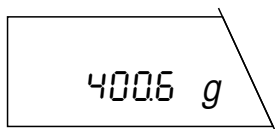

... the balance operates with **lower readability** (one decimal place less), but displays the result appreciably **quicker**. By pressing the «**1/10d**» key again briefly, you can return to normal readability.

3.7 Switching weighing units

Your balance can display the weighing result in two different weighing units. How you preselect the two weighing units is described in sections 4.10 and 4.11.

You can switch between the two weighing units at a keystroke:

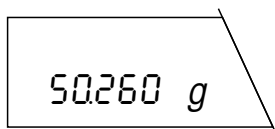

The balance shows the result in **weighing unit 1**.

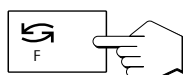

Press the «» key briefly.

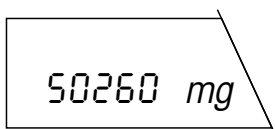

The balance shows the result in **weighing unit 2**. By pressing the «» key again, you can return to weighing unit 1.

Notes

If an additional unit (e.g. “%” or “PCS”) is displayed when switching between the two weighing units, you have preselected a function in the menu. You will find further information on the functions in sections 4.6 and 5.1 through 5.4.

The following weighing units are set in the factory:

For PG-S balances with 1 mg readability

Weighing unit 1: g (grams)

Weighing unit 2: mg (milligrams)

For PG-S balances with 10 mg readability

Weighing unit 1 : g (grams)

Weighing unit 2 : g (grams)

You will find a table of the conversion factors between the various weighing units in section 8.2.

3.8 Printing out the weighing result and transferring data

If your balance is connected to a printer via the RS232C interface or via the LocalCAN universal interface, you can transfer current weighing results, identifications and other data to the attached device with a single keystroke.

Press the «» key briefly. As soon as the weighing result is stable, the status indicator of the readability fades and the result is transferred to the attached device.

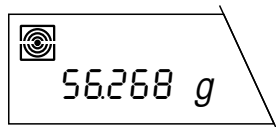
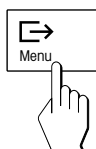

You will find additional information on the attachment of a printer in sections 6.4 and 6.5 and in the documentation accompanying your printer.

4. The menu

4.1 What is the menu?

The menu allows you to match your balance to your specific weighing needs. In the menu you can change the settings of your balance and activate functions.

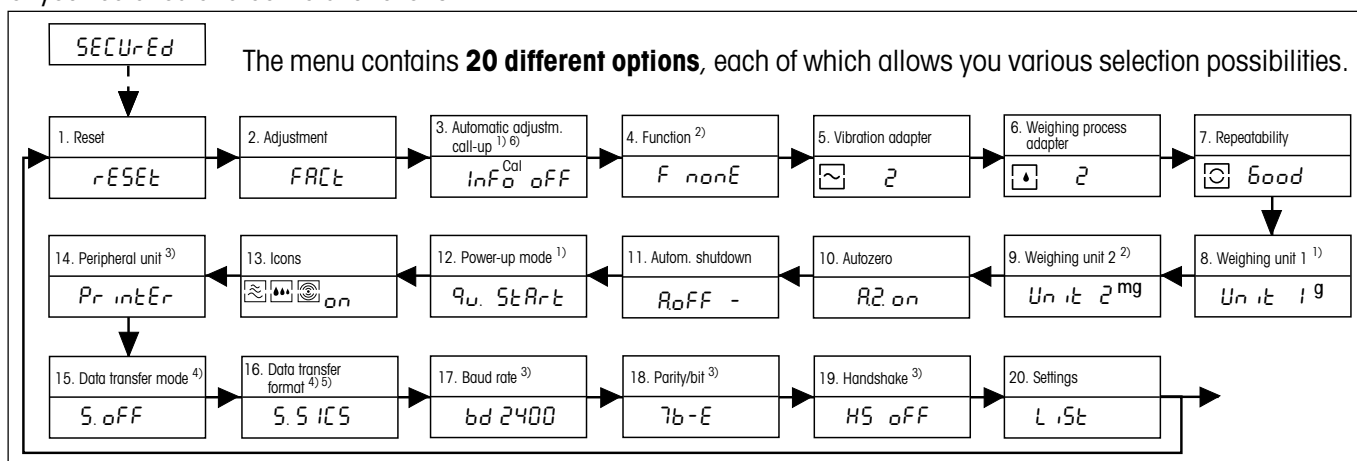

- | | |
|--|---|
| 1. Reset: | Call-up of the factory setting. |
| 2. Adjustment (calibration): | Default settings for the type and testing of the adjustment (calibration). |
| 3. Automatic adj. call-up ^{1) 6)}: | Switch adjustment call-up to the display on or off. |
| 4. Function ²⁾: | Preselec. of the func. you wish to have available in weighing operation at a keystroke. |
| 5. Vibration adapter: | Matching the balance to the ambient conditions. |
| 6. Weighing process adapter: | Matching the balance to different types of weighing. |
| 7. Repeatability: | Selection of the repeatability of the weighing results. |
| 8. Weighing unit 1 ¹⁾: | Specification of the 1st weighing unit in which the balance should show the result. |
| 9. Weighing unit 2 ²⁾: | Specification of the 2nd weighing unit in which the balance should show the result. |
| 10. Autozero: | Switching the automatic zero correction (Autozero) on or off. |
| 11. Automatic shutdown: | Preselection of the time after which the balance should be switched off automatically. |
| 12. Power-up mode ¹⁾: | Start without or with display test. |
| 13. Icons: | On or off switching of the icons. |
| 14. Peripheral unit ³⁾: | Attachment to a printer or host. |
| 15. Send commands ⁴⁾: | Selection of data transfer mode. |
| 16. Send format ^{4) 5)}: | Selection of data transfer format. |
| 17. Baud rate ³⁾: | Matching the transfer speed. |
| 18. Parity/bit ³⁾: | Matching the character format. |
| 19. Handshake ³⁾: | Transfer protocol |
| 20. Settings: | Saving or printing out all menu settings. |

¹⁾ With certified balances, these menu options have a fixed setting and can not be changed.

²⁾ With certified balances, only those weighing units/functions allowed by national weights and measures legislation can be selected.

³⁾ These menu options are shown only if your balance is equipped with an RS232C interface.

⁴⁾ These menu options are shown only if "HoSt" has been selected in menu option 14.

⁵⁾ These menu options are shown only if "S.oFF" has **not** been selected in menu option 15.

⁶⁾ This menu option is shown only if "FACT" or "CAL oFF" has **not** been selected in menu option 2.

Note: You will find a graphical overview of the entire menu with all setting possibilities in section 8.1.

4.2 Menu operation

In this section you will learn how to work with the menu. Information regarding the individual menu options and the available settings can be found in the following sections.

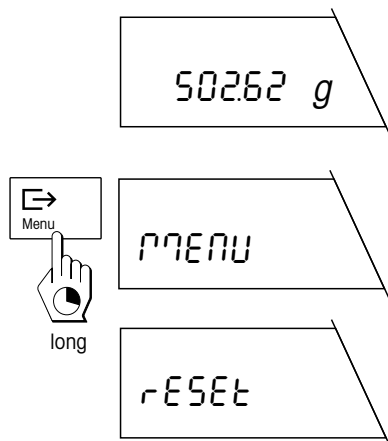

How to change from the weighing mode to the menu

The balance is operating in the normal weighing mode.

Press the «**Menu**» key and keep it pressed until the balance switches to the menu.

After release of the «**Menu**» key, the balance shows the first option directly ("Reset") with the current setting.

How to select the menu options

Press the «**Menu**» key briefly.

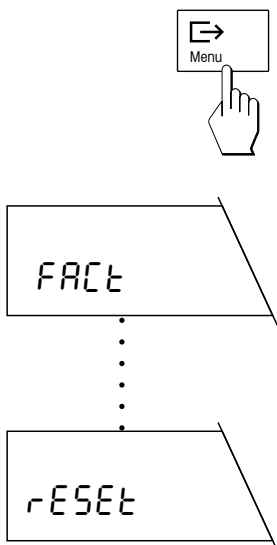

The next menu option appears in the display. Each time the «**Menu**» key is pressed, the balance switches to the following menu option.

After the last menu option ("Settings"), the first menu option ("Reset") is again shown.

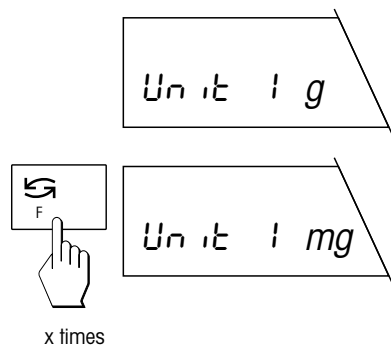

How to select the desired setting in a menu option

Press the «**F**» key briefly. The display shows the next setting available in the selected menu option. Each time the «**F**» key is pressed, the balance switches to the next setting. After the last setting, the first is again shown.

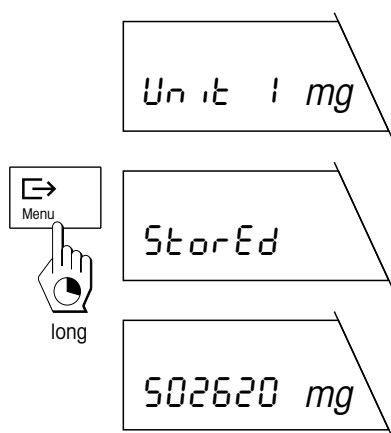

How to save your settings and quit the menu

After you have made all settings in the individual menu options, press the «**Menu**» key and keep it pressed until the balance returns to the weighing mode.

Before the normal weighing result display reappears, the balance briefly confirms saving of the settings.

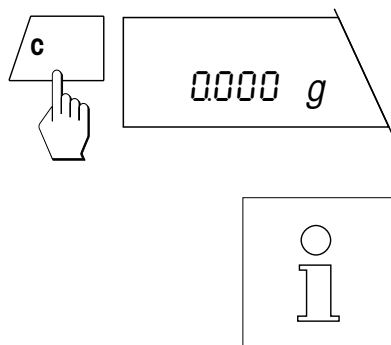

How to quit the menu without saving your settings

By pressing the «**C**» key briefly (your attention is drawn to the termination by a double beep), you can return to the weighing mode at any time **without changing the stored settings**.

If you do not press a key for 45 seconds, the balance **automatically** returns to the weighing mode. Changes you have made in the menu are **not saved!**

4.3 Reset

In this menu option you have the possibility to reset all menu settings to the factory setting.

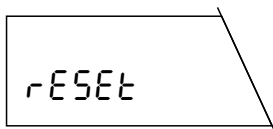

Resetting settings to factory setting

If you select this option and then save and quit the menu, all menu settings are reset to the values set in the factory.

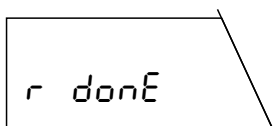

Before the return to the weighing mode, the resetting is briefly confirmed in the display.

4.4 Selection of the adjustment (calibration) and test function

Your balance can be adjusted (calibrated) with internal or external weights. The balance can also be checked by a test with internal or external weights. If you have attached a printer to your balance, the data of the adjustment (calibration) and the results of the test are printed out following GLP recommendations.

The following settings are available:

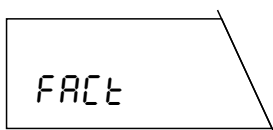

Fully automatic internal adjustment (calibration) FACT (Fully Automatic Calibration Technology)

This is the **factory setting**. The balance adjusts (calibrates) itself fully automatically

- after the warm-up phase following connection to the power supply,
- when a change in the ambient conditions, e.g. the temperature could lead to a noticeable measurement deviation,
- with certified balances, always independent of the settings in menu option Adjustment.

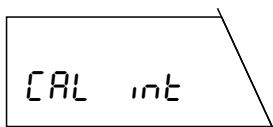

Internal adjustment (calibration)

Adjustment (calibration) is performed at a keystroke with the built-in weight.

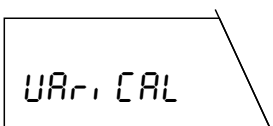

Adjustment (calibration) with external weights (VariCal)

Adjustment (calibration) is performed with a selectable* external weight.

* This function is blocked for certified balances.

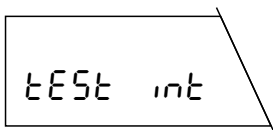

Test of the balance with internal weight

In this setting the accuracy test of the balance is performed with the internal weight.

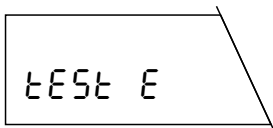

Test of the balance with external weights

The accuracy of the balance can be checked with any external weight.

You will find information on how to perform the adjustment and test function in sections 2.5, 5.6, 5.7 and 5.8.

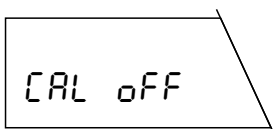

Switching off the adjustment and test function

The adjustment or test is switched off with the CAL key.

Note

Irrespective of the settings in the menu option Adjustment (Calibration), the fully automatic adjustment FACT is always active with certified balances.

4.5 Switching automatic adjustment call-up on or off

In this menu option you can switch the call-up of the automatic adjustment (calibration) or test on or off.

Note: If you have set «FACT» in the menu option Adjustment (calibration), the automatic adjustment call-up is always active and will thus be skipped in the menu. It becomes active again as soon as «FACT» is switched off.

The following settings are available:

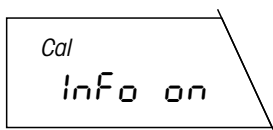

Automatic adjustment (calibration) or test call-up switched on

This is the **factory setting**. The balance prompts you with a flashing «Cal» in the display to adjust (calibrate) or test it with the internal weight or external weights. The call-up is triggered by, e.g. temperature changes of the surroundings.

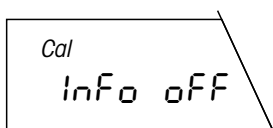

Automatic adjustment (calibration) or test call-up switched off

The automatic adjustment or test call-up is switched off.

Note

With the certified versions of balances, call up of the automatic adjustment or test can not be selected, i.e. FACT is always active.

4.6 Preselecting a function

In this menu option you can preselect a function which you then have available in the weighing mode at a keystroke.

Note: With certified balances, only the functions allowed by the national weights and measures legislation are available.



The following functions are available:

No function preselected

There is no function available in the weighing mode (**factory setting**).

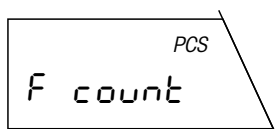

Piece counting

Your balance counts the pieces which you place in or remove from the weighing container.



Percent weighing

Your balance allows you to weigh in to a preselected value or it determines percent weight differences.

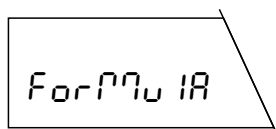
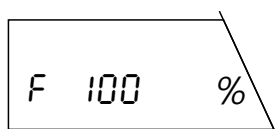

Simple formula weighing

The formula weighing function allows you to weigh in up to 255 individual components, store their weights and totalize these. If your balance is connected to a printer, all individual weights and the total weight of all components are printed out. In addition, up to 99 weighing containers can be tared. Your balance can save and print out the total weight of all weighing containers.

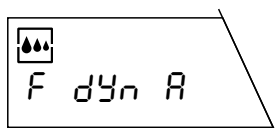

Dynamic weighing with automatic start

Your balance determines an average weighing result over a preset time interval. This setting is suitable for unstable weighing samples (e.g. animals). With this setting, the dynamic weighing starts automatically.

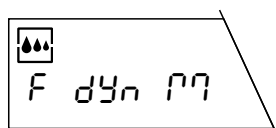

Dynamic weighing with manual start

Analogous to dynamic weighing with automatic start, but the weighing cycle must be started manually.

You will find details on how to work with the functions in section 5.

4.7 Setting the vibration adapter

The vibration adapter is used to match the balance to the ambient conditions (vibrations, drafts at balance location).

The following settings are available:

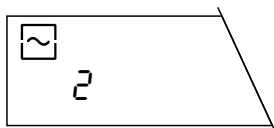

Setting for normal ambient conditions

This is the **factory setting** matched to normal ambient conditions.

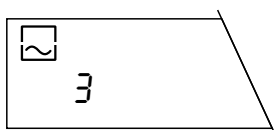

Setting for unstable surroundings

The filter setting of the balance is higher than in the factory setting, but the balance is less sensitive to external influences.

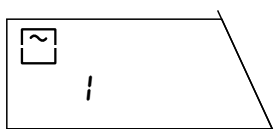

Setting for virtually disturbance-free, stable surroundings

The filter setting of the balance is lower than in the factory setting, but the balance is more sensitive to external influences.

4.8 Setting the weighing process adapter

The weighing process adapter is used to match your balance to the different types of weighings (absolute weighing, fine addition, etc.).

The following settings are available:



Universal setting

This is the **factory setting**, it is suitable for all types of weighings. The display always corresponds to the current weight.

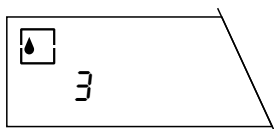

Absolute weighing

This setting is suitable for checkweighings and for the weight determination of samples.

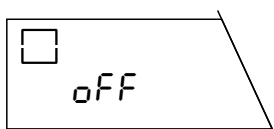

Special applications

In this setting, the displayed weight value has a fixed relation to the weight change with time.

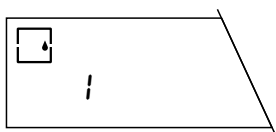

Fine addition

This setting is suitable for the weighing in of fine powders, small amounts of liquids, etc.

4.9 Selecting repeatability

In the left lower corner of the display you will find the circular symbol of the stability detector. As soon as the weighing result is within specified limit values over a certain time interval, the weighing result is considered stable and the symbol for the stability detector fades. With the setting for the repeatability ("Repro-Set"), you determine the time interval over which the result must lie within the limit values for it to be considered stable. The better the repeatability, the longer the weighing process lasts.

The following settings are available:

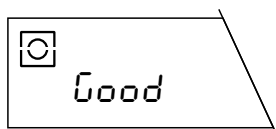

Good repeatability

The weight display is released as stable quickly, this is the **factory setting**.

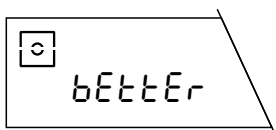

Very good repeatability

Slower release until stable weight display.

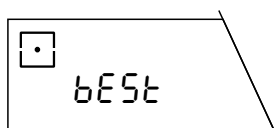

Best possible repeatability

Stable weight display is not released until several seconds without change.



Normal repeatability

The weight display is released as stable very quickly, in other words: The display for the stability detector fades very quickly.

4.10 Selecting weighing unit 1

In this menu option you specify the **unit*** in which the weighing result should be displayed.

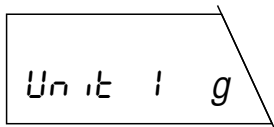

The following units * are available:

Display	Designation	Comments
g	gram	
mg	milligram	with 1 mg balances only
kg	kilogram	not with 1 mg balances
lb	pound	
oz	ounce	
ozt	troy ounce	
GN	grain	
dwt	pennyweight	
ct	carat	
mo	momme	
m	mesghal	

You will find a table with the conversion factors for the different units in section 8.2 of these operating instructions.

* With certified balances, the weighing unit has a fixed setting **g** (gram) and can not be changed.

4.11 Selecting weighing unit 2

In this menu option you specify the **additional unit*** in which the weighing result should be displayed.

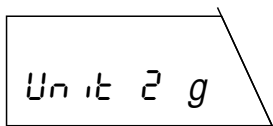

The following units are available:

Display	Designation	Comments
g	gram	
mg	milligram	with 1 mg balances only
kg	kilogram	
lb	pound	
oz	ounce	
ozt	troy ounce	
GN	grain	
dwt	pennyweight	
ct	carat	
mo	momme	
m	mesghal	
H tl	Hong Kong taels	
S tl	Singapore taels	
t tl	Taiwan taels	

You will find a table with the conversion factors for the different units in section 8.2 of these operating instructions.

* With certified balances, only those weighing units allowed by the respective national weights and measures legislation can be selected.

4.12 Switching automatic zero correction (Autozero) on or off

This menu option allows you to switch the automatic zero correction on or off. When it is switched on (factory setting), the zero point is automatically corrected for drift or contamination of the weighing pan.

The following settings are available:



Autozero switched on

This is the **factory setting**. The zero point is automatically corrected.



Autozero switched off

The zero point is not automatically corrected. This setting is advantageous for special applications (e.g. evaporation measurements).

Note

With certified balances, this setting is possible only with a resolution of $e = 10$ d.

4.13 Preselecting automatic shutdown

When the automatic shutdown is activated, the balance automatically switches itself off after a preselected time (calculated from the last operation) and is switched to the standby mode.

The following settings are available:

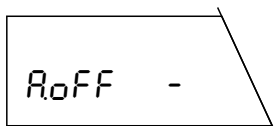

No automatic shutdown

The automatic shutdown is deactivated (**factory setting**).

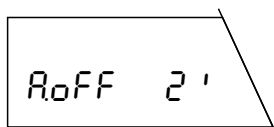

Automatic shutdown after 2 minutes

As soon as the balance has not been operated for 2 minutes, it switches itself off automatically.

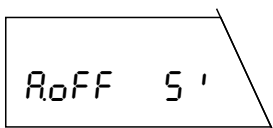

Automatic shutdown after 5 minutes

As soon as the balance has not been operated for 5 minutes, it switches itself off automatically.

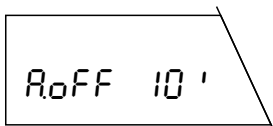

Automatic shutdown after 10 minutes

As soon as the balance has not been operated for 10 minutes, it switches itself off automatically.

4.14 Selecting the power-up mode

You can set your balance such that it either immediately starts from the standby mode when you load a weight or it must be switched on with the «**On/Off**» key after which it then performs a display test.

The following settings are available:

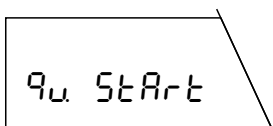

Quickstart*

This is the **factory setting**. The balance can be started directly from the standby mode and is immediately ready for weighing. You can load the weight in the standby mode and the balance immediately shows the current weighing result.

* Quickstart is not possible with certified balances.

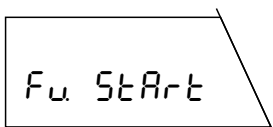

Start with display test

You must switch on the balance with the «**On/Off**» key. After it has been switched on, it performs a display test in which all display elements light up. On completion of the test, the balance is ready for weighing.

Note

If the balance has been disconnected from the power supply, it always performs a display test after it has been switched on again, even if the "Quickstart" setting has been selected.

4.15 Setting display of the icons

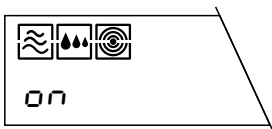

All icons appear in the display.



If desired, you can also switch off the icons. They disappear after about 10 seconds after you have quit the menu or after about 3 min. after the balance has been switched on.

Note: The menu options 4.16–4.21 are shown only if your balance is equipped with an RS232C interface.

4.16 Selecting peripheral device

In this menu option you can select the desired peripheral unit. The balance stores the corresponding settings (4.17–4.21) for each peripheral unit separately.

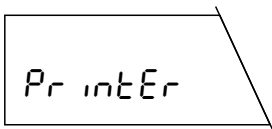

Attachment to a printer (e.g. METTLER TOLEDO LC-P45 Printer).

Factory setting : bd 2400, 7b–E, HS OFF

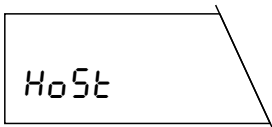

Attachment to any peripheral unit.

Factory setting: S. oFF, bd 9600, 8b–no, HS Soft

4.17 Selecting data transfer mode

In this menu block you tell the balance how a value should be transferred to a peripheral device (e.g. LC-P45). This menu option appears only if the setting “HoSt” has been selected in the menu option “Selecting peripheral device” (section 4.16).

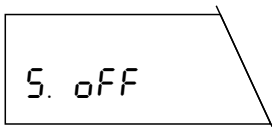

Data transfer mode switched off

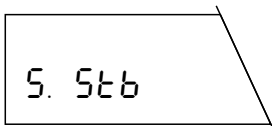

The next possible stable value will be transferred after triggering of the Print/Transfer command.

A rectangular box with a diagonal line on the right side, containing the text "S. ALL".

The current value will be transferred after triggering of the Print/Transfer command.

A rectangular box with a diagonal line on the right side, containing the text "S. Auto".

Only stable values will be automatically transferred after every weight change.

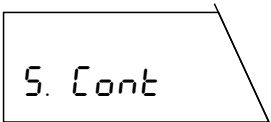
A rectangular box with a diagonal line on the right side, containing the text "S. Cont".

All values will be automatically transferred.

Note

The menu option "Data transfer mode" appears only if "HoSt" has been selected in the menu option "Selecting peripheral device" (see also section 8.1).

4.18 Selecting data transfer format

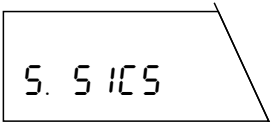
A rectangular box with a diagonal line on the right side, containing the text "S. SICS".

With this setting the data transfer formats described in MT-SICS are used. You will find the description in the enclosed description of the operating instructions (Reference manual MT-SICS).

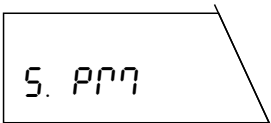
A rectangular box with a diagonal line on the right side, containing the text "S. PM".

With this setting the data transfer formats of the PM balances are used.

Note

If you wish to use other data transfer formats of the PM balances with your PG-S balance, please use the optional R/G-M emulation software cassette which emulates all interface commands of the PM balances (see section 7.3).

The interface is unidirectional. Incoming interface commands in the setting "S. PM" are not processed further.

The menu option "Selecting data transfer format" appears only if the setting "S. OFF" has not been selected in the menu option "Selecting data transfer mode" (see also section 8.1).

4.19 Setting baud rate (data transfer rate)

The data transfer rate (baud rate) determines the speed of the transfer via the serial interface. The unit is baud (1 baud (bd) = 1 bit/second).

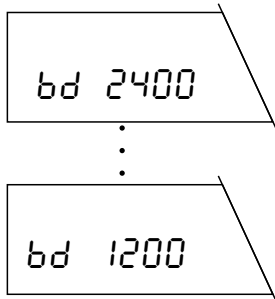

The following settings are available:

150 bd, 300 bd, 600 bd, 1200 bd, 2400 bd, 4800 bd and 9600 bd

4.20 Setting parity/bit

In this menu option you can set the character format for the attached peripheral unit.

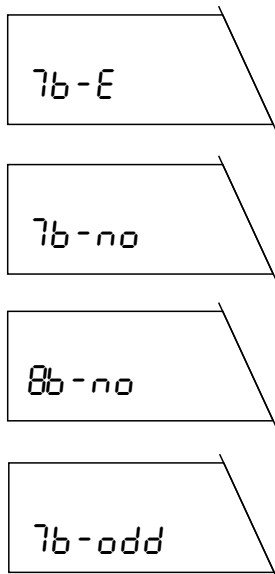

The following settings are available:

7 bit/even parity

7 bit/no parity

8 bit/no parity

7 bit/odd parity

4.21 Setting handshake

In this menu option the data transfer can be matched to various serial receivers.

The following settings are available:

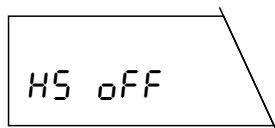

HS OFF

No handshake

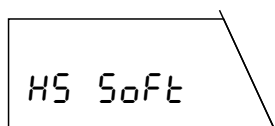

HS SOFT

Software handshake (XON/XOFF)

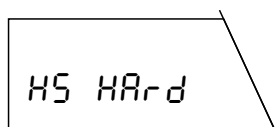

HS HARD

Hardware handshake

Note

If you have selected this setting, the attached peripheral unit must be switched on. If the peripheral unit is switched off, the balance will be blocked.

4.22 Printing out or saving menu settings

In this menu option you have the possibility to save all menu settings. You can also print out all current settings of the menu assuming your balance is connected to a printer.

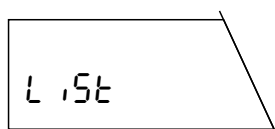

LIST

As soon as you save your settings and quit the menu, all settings defined in the menu are recorded on the attached printer.

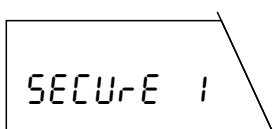

SECURE 1

With "secure 1" you can protect the menu settings against inadvertent changes.

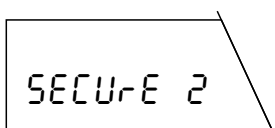

SECURE 2

With "secure 2" you can protect both the menu settings and also the  key, which triggers the adjustment function or lowers the readability of the display, against inadvertent changes.

Note

If the adjustment function "FACT" is set in the menu option, the PG-S balance also automatically performs an internal adjustment in the setting "secure 2".

```

----- LIST -----
03.10.97      16:49:06

METTLER TOLEDO
Balance
Type:      PG2002-S
SNR:      1113170358

SW-Ver.:  1.74 1.30
Cal:      FACT
Function:  none
Vibr.:    2
Wghpro.:  2
Repro.:   good
Unit 1:   g
Unit 2:   oz
A.Zero:   on
A.off:    -
Start:    Qu. Start
Icons:    on
Output:   Printer
Baud:     2400
Bit:      7
Parity:   even
Handshake:off
----- END -----

```

The record shown opposite is a **specimen** which can be printed out, e.g. with the METTLER TOLEDO LC-P45 Printer. Depending on the selected settings and the selected connection with LocalCAN or RS232 interface, the representation may differ from the example shown.

4.23 Canceling secure function

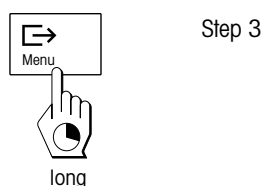
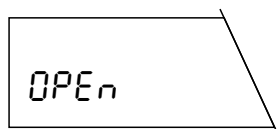
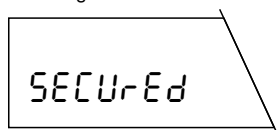
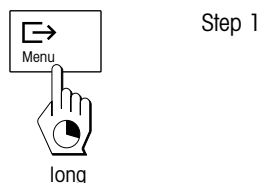

If "secure" is selected in the menu, "secure" appears when it is reentered (initiated by the menu key). If you do not press the «↶» key for more than 3 seconds, the balance automatically returns to the weighing mode (menu remains blocked).

After the «↶» key has been pressed, "Open" appears. Confirm this within 3 seconds by pressing and holding the menu key, entry into the menu is then possible again (menu open).

Note

The release applies to "SECUR 1" and "SECUR 2".

5. Special applications and functions

Your balance can do more than just weigh. Built-in applications and functions expand the possibilities of your balance and facilitate your daily work. The following sections will acquaint you with these applications and functions.

5.1 Piece counting

Piece counting presupposes that you have preselected the function "F count" ("PCS" or "Stk") in the menu (see section 4.6).

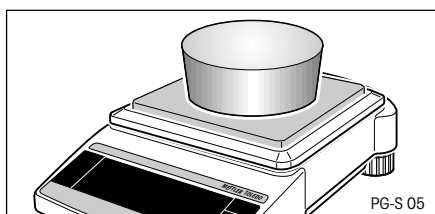

Load the empty container.

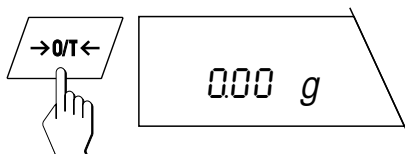

Press the « $\rightarrow 0/T \leftarrow$ » key to tare the balance.

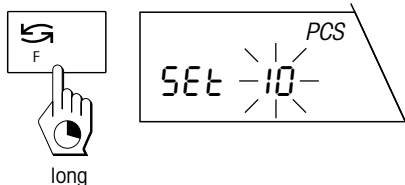

Your balance now needs the weight of a **reference piece number**. Press and hold the «F» key until you are prompted to load the reference pieces.

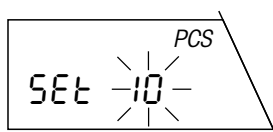

Your balance suggest "10" as reference piece number. You can accept this suggestion or select one of the the available reference piece numbers (20, 30, 50, 100 or 5 pieces) by briefly pressing the « \rightarrow » key.

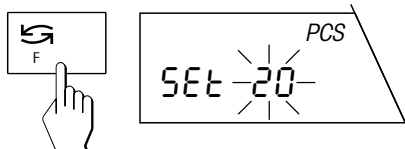

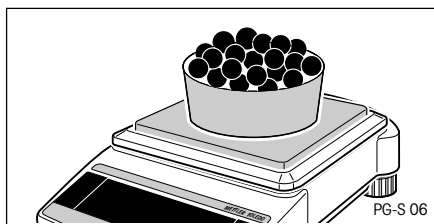

Note

We advise you to select a reference piece number as large as possible as the balance determines the average weight per piece and saves it as the reference weight. As it is seldom the case that all pieces have the exactly the same weight, the accuracy of the reference weight increases with increasing reference piece number.

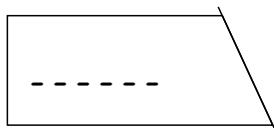
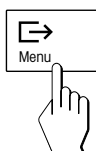

Now load the selected number of reference pieces.



Then briefly press the «» key. As long as the horizontal dashes are displayed, the balance is calculating the reference weight.

Note

If you do not press a key for 45 seconds, the balance returns to the weighing mode.

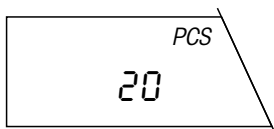

After your balance has determined the reference weight, it shows the correct piece number and is now ready for piece counting.

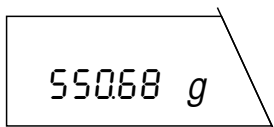
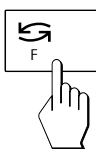

You can use the «» key at any time to switch the display between the piece number display, weighing unit 1 and weighing unit 2.

Note

The current set weight remains stored until it is redetermined or the power supply of the balance is interrupted.

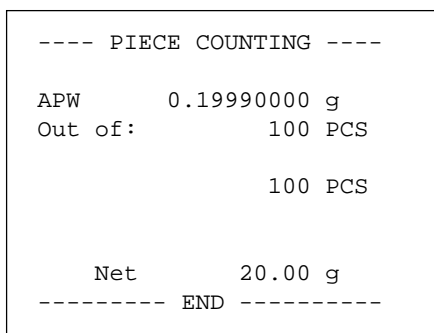
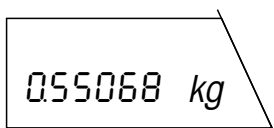
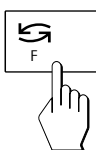

If a printer is connected to your balance, the reference weight, the reference piece number, the total piece count as well as the net weight of the total piece count are printed out.

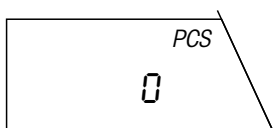
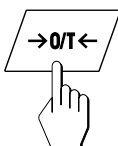

Note

If a printer is attached, you can start a new piece counting with the «» key.

5.2 Percent weighing

The "Percent weighing" function allows you to weigh in to a preset value (100 %) and determine the deviations from this target value. The DeltaTrac helps you quickly determine the position of the sample weight regarding the tolerances (see section 3.4).

Percent weighing presupposes that you have preselected the function "F 100 %" in the menu (see section 4.6).

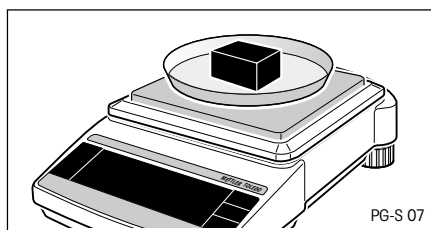

Load the empty container.



long

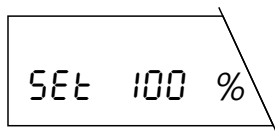

Your balance needs a reference weight that should correspond to 100%. Press and hold the «F» key until you are prompted to load the reference weight. Now load the reference weight.

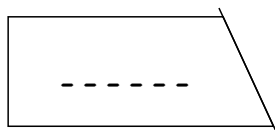

Then briefly press the «E» key. As long as the horizontal dashes are shown, your balance is calculating the reference weight.

Note

If you do not press a key for 45 seconds, the balance returns to the weighing mode.

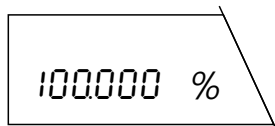

On completion of the weighing-in procedure, your balance is ready for percent weighing.

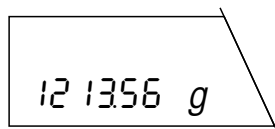

You can use the «G» key at any time to switch the display between percent display, weighing unit 1 and weighing unit 2.

Note

The current piece weight remains stored until it is redetermined or the power supply of the balance is interrupted.

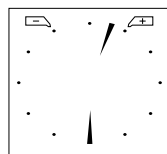
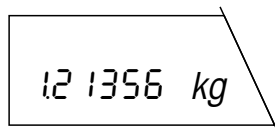

Weight within tolerance

The position of the sample weight regarding the tolerances can be quickly determined with the DeltaTrac. The taring range is $\pm 2.5\%$ of the target weight. The setting of this tolerance range is fixed and can be changed only via the interface.

5.3 Formula weighing

With the formula weighing function you can weigh and totalize individual weights (components). Your balance processes up to 255 components per formula weighing operation. In addition, you can tare up to 99 weighing containers for each formula weighing operation. If your balance is connected to a printer, the entire formula weighing operation can be recorded.

Formula weighing presupposes that the function "Formula" has been preselected in the menu (see section 4.6).

Unload the weighing pan.

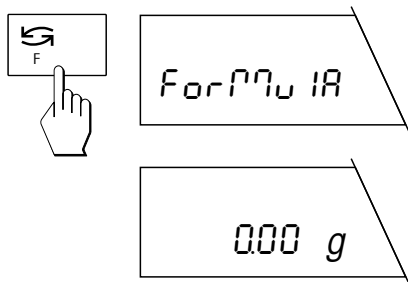

Press the «**F**» key briefly and the display confirms that the formula weighing function is active.

After 2 seconds, the normal weight display appears.

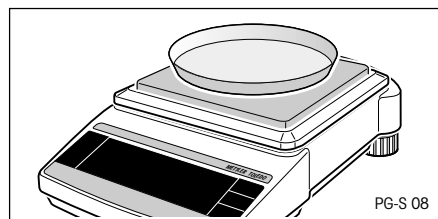

If you wish to tare a weighing container, place this on the pan.

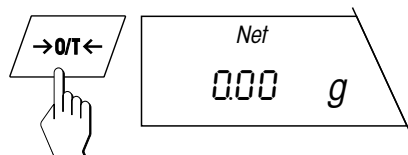

Then press the «**→0/T←**» key briefly.

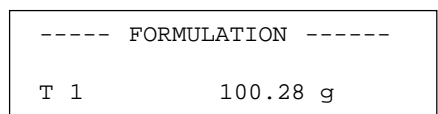

If your balance is connected to a printer, the tare weight is printed out.

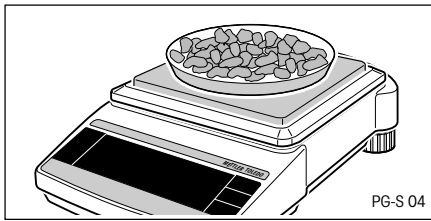

Add the first container to the weighing container.

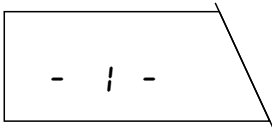
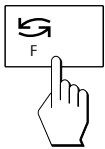

Then press the «» key briefly. The display shows "- 1 -" briefly to confirm the weighing in of the first component.

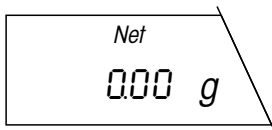



After weighing in of the first component, the display is reset to zero and the balance is now ready for weighing in of the second component.

----- FORMULATION -----		
T 1		100.28 g
1	Comp.	12.00 g

If a printer is attached, the weight of the components is printed out.

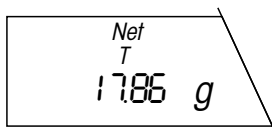
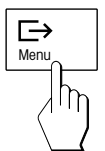
Now weigh in the additional components as described above.



As soon as you have weighed in all components, press the «» key briefly to end the formula weighing operation. The total weight of all individual components is displayed briefly.

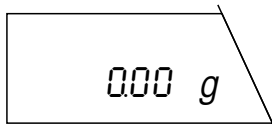

The balance then returns to the normal weighing mode.

The weight memories for tare and net total are now cleared and the balance is ready for the next formula.

----- FORMULATION -----		
T 1		100.28 g
1	Comp.	12.00 g
2	Comp.	2.56 g
3	Comp.	3.30 g
T total		100.28 g
G		118.14 g
N total		17.86 g
----- END -----		

If a printer is attached to your balance, a record with the net total weight of all components "N total", the tare weight (weight of the weighing container) "T total" and the total weight (total weight of all components plus tare weight) "G" is printed out.

During the formula weighing operation you can increase the net total weight to a desired value

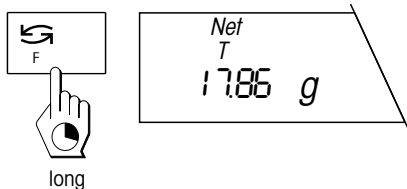

Press and hold the «F» key until the net total weight of all components weighed in so far is displayed.

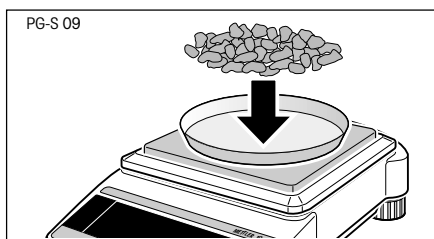

Now add the component to the container until the desired net total weight is reached.

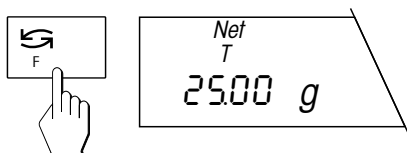

Press the «F» key briefly and the desired weight is confirmed as an additional component.

During the formula weighing operation you can always display the totalized total weight and the number of components weighed in so far

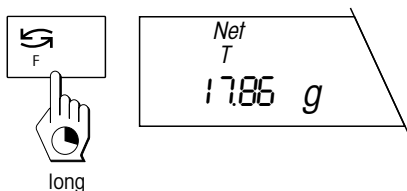

Press and hold the «F» key until the weight of all components weighed in so far is displayed.

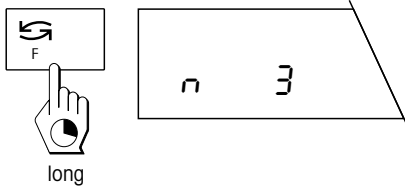

Press and hold the «F» key again until the number "n" of all components weighed in so far is displayed.

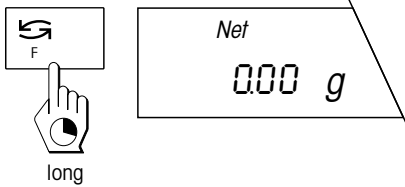

Press and hold the «F» key until the balance switches back to the weight display. You can now weigh in additional components.

During the formula weighing operation you can always tare additional weighing containers

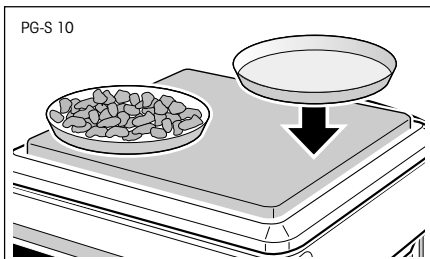

Place the additional weighing container on the weighing pan next to weighing containers already tared.

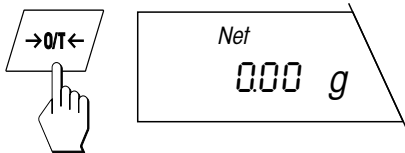
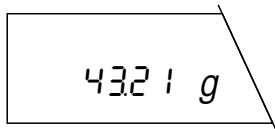

Press the « $\rightarrow 0/T \leftarrow$ » key briefly. The balance is now tared with the additional weight of the new weighing container. If your balance is connected to a printer, the tare weight of the new container is printed out. You can now weigh in additional components.

T 2	43.21 g
-----	---------

T total	143.49 g
G	161.35 g
N total	17.86 g
----- END -----	

If you print out the results at the end of the formula weighing operation, all tare weights are totalized and the total weight of all tare containers ("T total") is recorded.

5.4 Dynamic weighing of unstable weighing samples

The functions “Dynamic weighing with automatic start” and “Dynamic weighing with manual start” facilitate your weighing of unstable weighing samples (e.g. animals). With this type of weighing, your balance determines the weight over a particular time period and calculates a representative mean value.

Dynamic weighing presupposes that you have preselected the function “F dyn A” or “F dyn M” in the menu (see section 4.6).

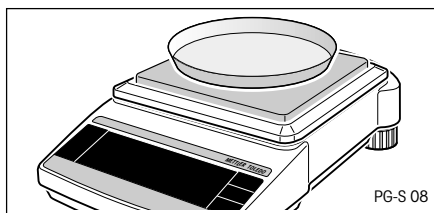

If you are working with a weighing container, place it on the weighing pan in the normal weighing mode.

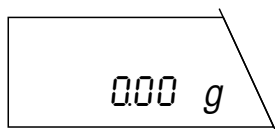
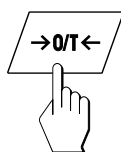
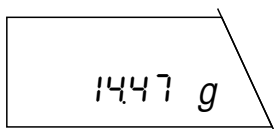

Press the «>0/T<» key to tare the balance.

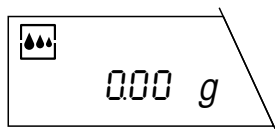
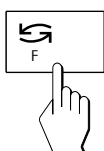

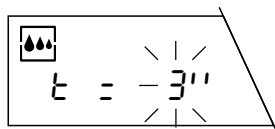
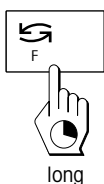

Press the «↻» key briefly. The symbol of the weighing process adapter in the display confirms that dynamic weighing has been activated.

Your balance is set in the factory so that the weight is determined over a period of 3 seconds. You need perform the following 3 steps only if you wish to change this time interval.

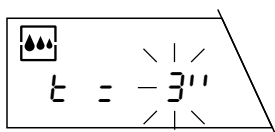

Press and hold the «F» key until the time display appears.





By pressing the «» key briefly, you can select one of the available time intervals (1, 2, 3, 5, 10 or 20 seconds).

Notes

The more unstable the weighing sample, the longer the time interval which should be selected.

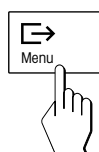
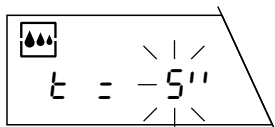
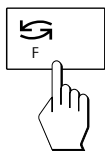
If you do not press a key for 45 seconds, the balance quits the display without changing the inputted value.



Then press the «» key briefly to confirm the selected time interval.

Your balance is now ready for dynamic weighing.

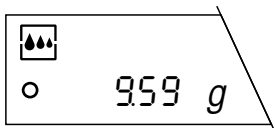

Load the weighing sample.

If you have selected the function "Dynamic weighing with **automatic start**" in the menu, the weighing starts automatically on relative stability. However, the **weighing sample** must weigh **at least 5 grams**.

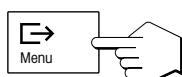

If you have selected the function "Dynamic weighing with **manual start**" in the menu, press the «» key briefly to start the weighing.

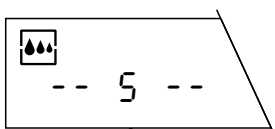

The remaining weighing time (in seconds) is displayed continuously.

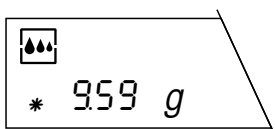
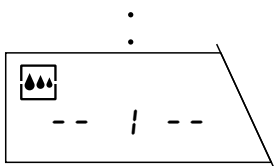

On elapse of the weighing time, read off the result. The asterisk symbol "*" lights up in the lower left corner of the display. This symbol indicates that the value is the mean value of the performed weighings, in other words a **calculated result**. The result remains in the display until the weighing sample is removed. If you wish to weigh the same weighing sample again, press the «» key briefly.

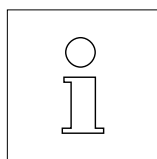

The set weighing time (time interval) remains stored until it is changed or the power supply of the balance is interrupted.

By **briefly pressing** the «» key, you can switch between the normal weighing mode and dynamic weighing at any time.

By **pressing and holding** the «**F**» key when in the dynamic weighing mode, you can recall the preselected time interval to the display and change it.

5.5 Below-the-balance weighings

Your balance is fitted with a hanger for below-the-balance weighings.

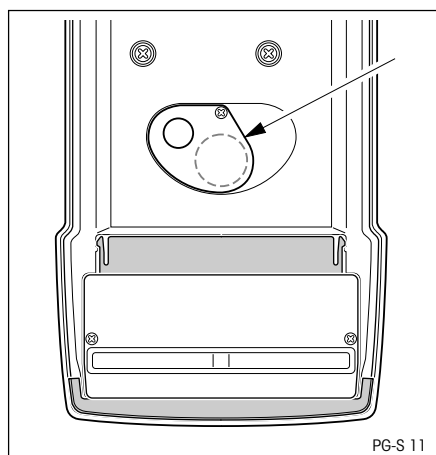

For PG-S balances

Loosen cover on the underside of the balance and turn as far as it will go. You can now see the hook of the below-the-balance weighing device. Using this hook, you can perform weighings up to full load.

5.6 Adjustment (calibration) with internal weight

Depending on the setting selected in the menu (see section 4.4), the adjustment (calibration) can be performed with the built-in, internal weight fully automatically (FACT) or semi-automatically.

Fully automatic internal adjustment (calibration) FACT

Your balance is set in the factory for the fully automatic adjustment with the internal adjustment weight. You are already familiar with this setting from sections 2.5 and 4.4.

Semi-automatic adjustment (calibration)

If your balance is outside the adjustment tolerance and depending on whether you have set the automatic adjustment call-up in the menu (see section 4.5), the balance uses a flashing «Cal» in the display to prompt you to adjust (calibrate) with the internal weight at a keystroke. With certified balances, the adjustment (calibration) with the internal weight is performed automatically in accordance with the national weights and measures legislation. An adjustment (calibration) with external weights is not allowed by the weights and measures legislation.

If you wish to adjust your balance with an internal weight, proceed as follows:

Make sure that "FACT" or the "Adjustment (calibration) with internal weight (Cal int)" is selected in the menu (see section 4.4).

Ensure that the weighing pan is unloaded and close the doors of the draft shield (if used). There is no need to tare the balance before the adjustment (calibration).

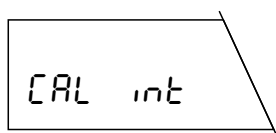
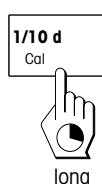

Start the adjustment operation by pressing and holding the «Cal» key. The balance briefly shows that adjustment (calibration) is being performed with the internal weight.

Note

If "SECURed 2" is switched on in the menu, the  key is blocked.

The following displays appear during the adjustment (calibration):

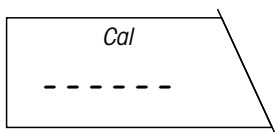

The internal adjustment weight is being loaded.

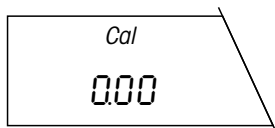

The internal adjustment weight is being raised.

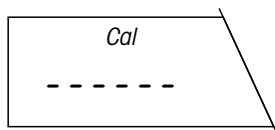

The balance is processing the adjustment results.

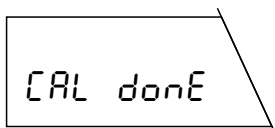

The balance reports successful completion of the adjustment (calibration).

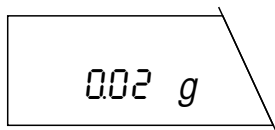

The balance automatically returns to the weighing mode.

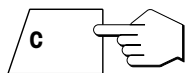

You can always abort an ongoing adjustment (calibration) by briefly pressing the «C» key (double beep).



If the adjustment (calibration) can not be performed properly (e.g. as a result of vibrations), the balance aborts the adjustment operation and "Abort" appears in the display. Press the «C» key to clear this message and restart the adjustment operation.

```

- BALANCE CALIBRATION -
03.10.97      11:23:34

METTLER TOLEDO
Type:          PG802-S
SNR:          1105238536
SW:           1.74 1.30

Internal cal. done

Signature:

.....
-----  END  -----
    
```

If your balance is connected to a printer, the adjustment (calibration) is recorded automatically in conformance with GLP. The record shown opposite is a specimen printed with the METTLER TOLEDO LC-P45 Printer. Depending on the attached printer, the printout may differ somewhat from the example shown.

5.7 Adjustment (calibration) with external weights (VariCal)

Depending on the setting selected in the menu (see section 4.4), the adjustment (calibration) can be performed with the built-in weight or with external weights. In the factory setting, the balance is set to adjustment with the internal weight, which you are already familiar with from section 2.5.

If you wish to adjust your balance with external weights, proceed as follows:*

* The adjustment (calibration) with external weights is not possible with certified balances.

Make sure that "Adjustment (calibration) with external weights (VariCal)" is selected in the menu (see section 4.4).

Ensure that the weighing pan is unloaded and close the doors of the draft shield. There is no need to tare the balance before the adjustment (calibration).

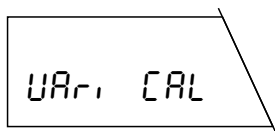
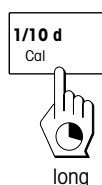

Start the adjustment operation by pressing and holding the «**Cal**» key. The balance shows briefly that adjustment is being performed with external weights.

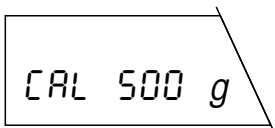

The balance now prompts you to select the desired weight. If you do not press a key for 3 seconds, the balance automatically initiates the adjustment process.

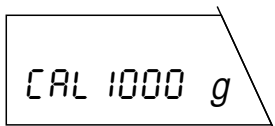
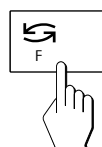

If you do not wish to adjust with the suggested weight, you can select a different weight by pressing the «**F**» key briefly. The available weights depend on the balance model.

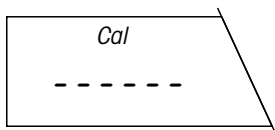
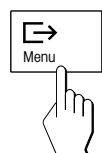

Confirm the selected weight with the «**Menu**» key. This initiates the adjustment process. The balance determines the zero point.

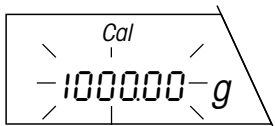

You are then prompted to load the weight.

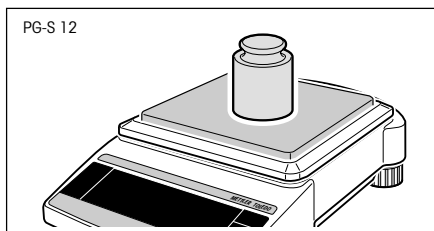

Place the requested weight in the middle of the weighing pan.

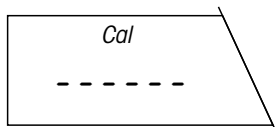

During the adjustment the horizontal segments are displayed.

Note

You can abort the ongoing adjustment at any time by pressing the «C» key briefly.



On completion of the adjustment operation, you are prompted to remove the weight. Lift the weight off the weighing pan.

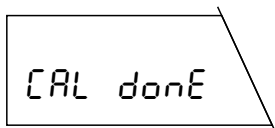

After removal of the weight, the balance shows the end of the adjustment operation and then returns to the weighing mode.

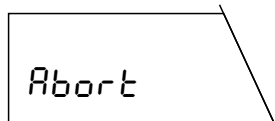
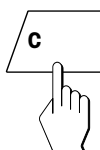

Note

If the adjustment (calibration) can not be performed properly (e.g. as a result of vibrations), the balance aborts the adjustment operation and "Abort" appears in the display. Press the «C» key to clear this message and restart the adjustment operation.

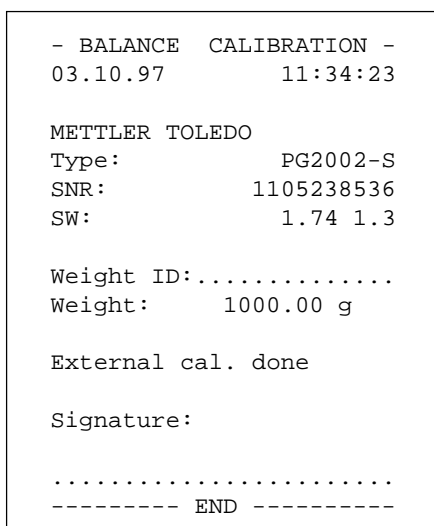

If your balance is connected to a printer, the adjustment is recorded automatically in conformance with GLP. The record shown opposite is a specimen printed with the METTLER TOLEDO LC-P45 Printer. Depending on the attached printer, the printout may differ somewhat from the example shown.

5.8 Test of the balance with internal weight or external weights

You can always test the accuracy of your balance. This test is performed either with the built-in weight or with external weights, depending on your setting in the menu (see section 4.4).

Test of the balance with the internal weight

Make sure that the "Test of the balance with the internal weight" (test int) is selected in the menu (see section 4.4).

Ensure that the weighing pan is unloaded and close the doors of the draft shield (if used). There is no need to tare the balance before the test.

Initiate the test procedure by pressing and holding the «Cal» key. The balance briefly confirms that the test is being performed with the internal weight.

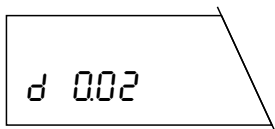
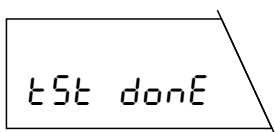
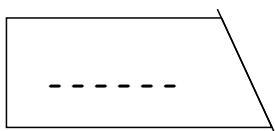
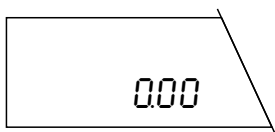
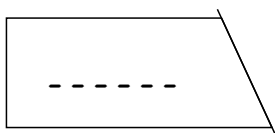
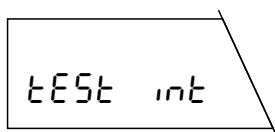
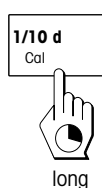

The following displays appear during the test:

The balance determines the zero point.

The balance is processing the results of the test.

The balance confirms that the test has been performed.

Over a period of 10 seconds, the balance now shows the difference (deviation) between the adjustment (calibration) and the current test weighing.

On completion of the test, the balance automatically returns to the weighing mode.



Notes

You can always abort an ongoing test by pressing the «C» key briefly. If the test can not be performed properly (e.g. as a result of vibrations), the balance aborts the operation and "Abort" appears in the display. Press the «C» key (double beep) to clear this message and restart the test.

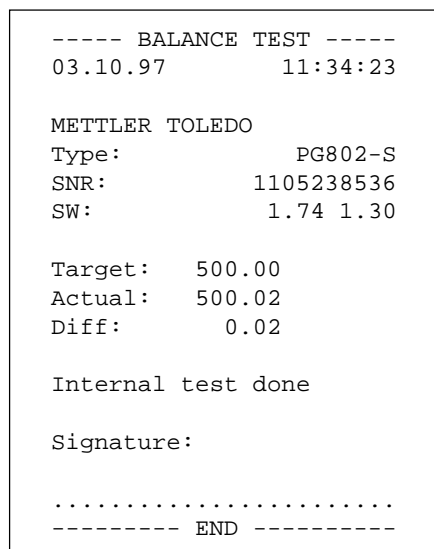

If your balance is connected to a printer, the measured difference is recorded automatically. The record shown opposite is a specimen printed with the METTLER TOLEDO LC-P45 Printer. Depending on the attached printer, the printout may differ somewhat from the example shown.

Test of the balance with external weights

Make sure that the "Test of the balance with external weights" (test E) is selected in the menu (see section 4.4).

Ensure that the weighing pan is unloaded and close all doors of the draft shield (if used). There is no need to tare the balance before the test.

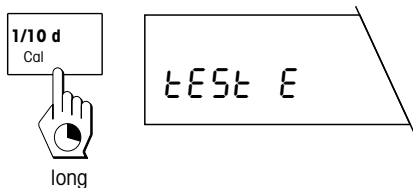

Initiate the test procedure by pressing and holding the «Cal» key. The balance briefly confirms that the test is being performed with an external weight.

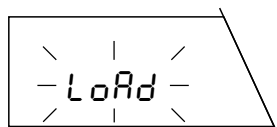

The balance prompts you to load the external weight. Place your weight on the pan.

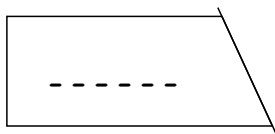

During the test, the horizontal segments are displayed.

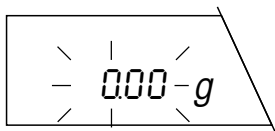

The balance now prompts you to remove your weight. Lift off the weight.

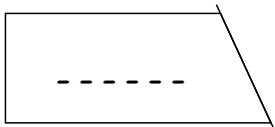

After removal of the weight, the balance processes the results of the test.

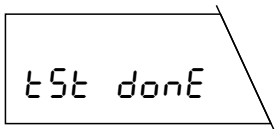

The balance confirms that the test has been performed and then automatically returns to the weighing mode.

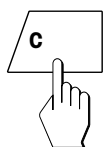

Notes

You can always abort an ongoing test by pressing the «C» key briefly.

If the test can not be performed properly (e.g. as a result of vibrations), the balance aborts the operation and "Abort" appears in the display. Press the «C» key (double beep) to clear this message and restart the test.

```

----- BALANCE TEST -----
03.10.97          15:21:17

METTLER TOLEDO
Type:             PG802-S
SNR:              1105238536
SW:               1.74 1.30

Weight ID:.....

Target:           .....
Actual:           500.00 g
Diff:             .....

External test done

Signature:



.....
----- END -----
    
```

If your balance is connected to a printer, the measured weight of the external test weight is recorded automatically. You can now enter the target weight ("Target") and the difference ("Diff") in the record by hand. The record shown opposite is a specimen printed out with the METTLER TOLEDO LC-P45 Printer. Depending on the attached printer, the printout may differ somewhat from the example shown.

6 Further important information

6.1 Error messages

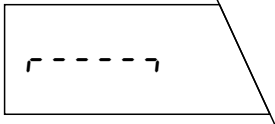
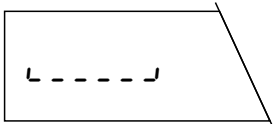
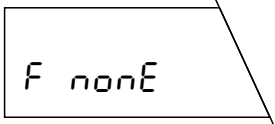
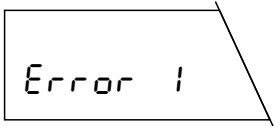
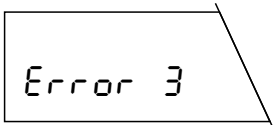
Error messages in the display draw your attention to incorrect operation or that the balance could not execute a procedure properly.

Error message	Cause	Rectification
	Overload	Unload weighing pan
	Underload	Check that the weighing pan is positioned correctly.
	No function preselected	Preselect desired function in the menu.
	No stability – On taring or adjustment (calibration) – On loading the reference weight for the functions "Piece counting" or "Percent weighing".	Ensure more stable ambient conditions. If not possible, check settings of the repeatability and vibration adapter (see sections 4.9 and 4.7).
	Faulty reference (Reference weight or reference piece number too low)	Increase reference weight or reference piece number.
	Wrong or missing weighing pan	Mount correct weighing pan. Unload weighing pan.

Error message	Cause	Rectification
	<p>Adjustment (calibration) or test could not be performed properly.</p> <p>The balance aborts the procedure. This error message is caused by external disturbing influences (e.g. vibrations or powerful drafts).</p>	<p>Press «C» key (a double beep sounds as confirmation) to clear the error message.</p> <p>Close all draft shield doors.</p> <p>Possibly select a more suitable location for the balance.</p>
Balance blocked	In the menu option Handshake, setting "HS Hard" selected.	Switch on attached peripheral device.

6.2 Preventive maintenance and care

Servicing

Regular servicing of your balance by an authorized service engineer ensures constant accuracy for years to come and prolongs the lifetime of the instrument. Ask your METTLER TOLEDO dealer for details of the available service options.

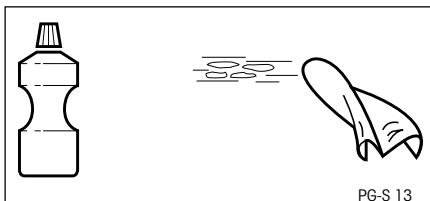

Cleaning

The balance housing and the weighing pan are made of high-grade, resistant materials. All commercially available cleaning agents may thus be used for cleaning.

PG-S balances can best be cleaned with a damp cloth.

6.3 Changing the protective cover

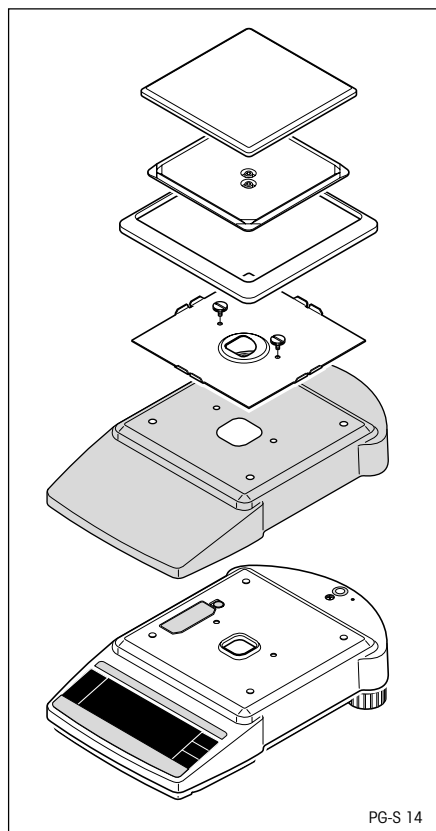

If you operate your balance in an environment liable to cause contamination, we recommend you cover it with the supplied transparent protective cover for the keypad and display.

Contaminated protective covers of all balance models can be changed, see Optional equipment in section 7.3.

Cleaning beneath the weighing pan

- Remove the weighing pan, the weighing pan support and the draft shield element.
- Remove the knurled screws and the fastening plate, as well as the protective cover (if used).
- You can now clean the dirty parts under running water.

6.4 RS232C interface

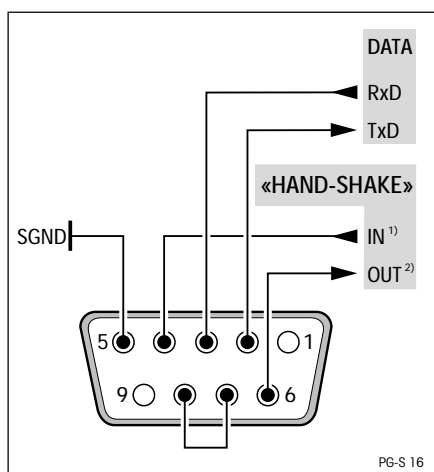

- 1) Ready to send
2) Ready to receive

Each PG-S balance is equipped with an RS232C interface as standard for the attachment of a peripheral device (e.g. printer or computer).

- 9-pin socket
- Matching to the other device (transfer parameters) is possible via the menu settings (see sections 4.16–4.21)

The versatile features of the PG-S balances regarding documentation of the results can not be utilized to the full until a printer, e.g. the LC-P45 from METTLER TOLEDO is attached. The printed results make a decisive contribution to a simple working procedure following GLP/GMP.

Notes

If you wish to attach several peripheral devices at the same time, it is simple to retrofit your PG-S balance with the LocalCAN universal interface (see section 6.5).

You will find a detailed description of the available interface commands in the enclosed brochure "Reference manual MT-SICS".

6.5 LocalCAN universal interface

As an option, your PG-S balance can be retrofitted with a LocalCAN universal interface. As you can attach up to five peripheral units at the same time, it offers you a high degree of flexibility in data interchange.

Peripheral units (see section 7.3) from METTLER TOLEDO which have the connection cable as part of their standard equipment can be attached in a simple manner to the balance.

The communication is particularly well supported by the commands of the standard and extended command set. The reference manual (705184) that you received with the LC-RS or LC-CL cable describes the functioning of these commands in an easily surveyed manner.

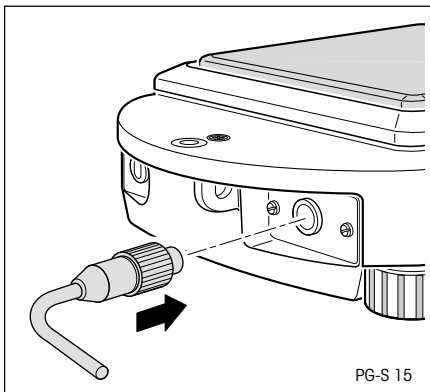

The features and benefits of the LocalCAN universal interface can be summarized as follows:

- Attachment of up to five peripheral units to a balance at the same time.
- Support of standard interfaces such as RS232C or CL.
- Rugged, 4-pin connector with reversed voltage and pullout protection.
- Dependable data transfer thanks to built-in CAN controller.
- Open cabling system, i.e. each peripheral unit except auxiliary displays have an additional connection.
- Simple configuration of the parameters without recourse to the operating instructions of the PG-S balance.

The versatile features of the PG-S balances regarding documentation of the results can not be utilized to the full until a printer, e.g. the LC-P45 from METTLER TOLEDO is attached. The printed results make a decisive contribution to a simple working procedure following GLP/GMP.

Technical data of the LocalCAN universal interface

Cable length between two devices, maximum 10 m.

Total cable lengths of all attached devices, maximum 15 m.

Pin assignment (balance end)

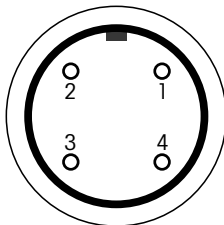

Pin No.	Signal
1	negative signal line (-CAN)
2	positive signal line (+CAN)
3	plus pin of power supply (V CAN) for peripherals
4	minus pin of power supply (0 V) for peripherals

7. Technical data and optional equipment

7.1 Technical data of the PG-S balances

Power supply with AC/AC adapter

separate AC adapter	115V, -15%+10%, 50/60Hz,	195 mA,	sec: 12 V, 50/60 Hz, 1.25 A
or	230V, -15%+10%, 50/60Hz,	90 mA,	sec: 12 V, 50/60 Hz, 1.25 A

Fusing

separate AC adapter	Overtemperature protection switch
---------------------	-----------------------------------

Power supply PG-S balance 9,5–17,5V, 50/60Hz, 10 VA or 9–20V =, 7W

Ambient conditions for PG-S balances

Height above sea level	up to 4000 m
Temperature	5–40° C
Atmospheric humidity	80% RH @ + 30° C
Overvoltage category	II
Pollution degree	2

Standard equipment

- RS232C interface
- Protective cover
- Feedthrough for below-the-balance weighing
- Device for theft protection
- Device for stand fastening
- Integrated short-form instructions
- AC adapter with holder
- Operating instructions
- Short-form operating instructions
- Description of interface commands (Reference manual MT-SICS)

Technical data	PG203-S	PG403-S	PG403-S Delta Range®	PG503-S *)
Readability	0.001 g	0.001 g	0.001 g/0.01 g	0.001 g
Maximum capacity	210 g	410 g	80 g/410 g	510 g
Taring range	0 ... 210 g	0 ... 410 g	0 ... 410 g	0 ... 510 g
Repeatability (s)	0.0008 g	0.0008 g	0,0008 g/0,003 g	0.0008 g
Linearity ¹⁾	±0.002 g	±0.002 g	±0.002 g/±0.005 g	±0.002 g
Stabilization time (typical)	1...2.5 s	1...2.5 s	1...2 s	1...2.5 s
Adjustment • with internal weight • with external weights ⁴⁾	internal, fully automatic motorized initiation (FACT) test possibility for checking the sensitivity 100/200 g ⁴⁾ 200/300/400 g ⁴⁾ 100/200/300/400 g ⁴⁾ 200/300/400/500 g ⁴⁾			
Sensitivity • Temperature drift ^{1) 2)} • Long-term drift ^{1) 3)}	±5 ppm/°C ±0.0025 %	±3 ppm/°C ±0.0015 %	±3 ppm/°C ±0.0015 %	±3 ppm/°C ±0.0015 %
Weighing pan	128x128 mm			
All-purpose draft shield (glass)	standard			
Effective height above pan	137 mm			
Dimensions (w/h/d)	226/239/360 mm			
Net weight	4.7 kg			

Technical data	PG503-S *) Delta Range®	PG603-S	PG603-S Delta Range®	PG1003-S
Readability	0.001 g/0.01 g	0.001 g	0.001 g/0.01 g	0.001 g
Maximum capacity	100 g/510 g	610 g	120 g/610 g	1010 g
Taring range	0 ... 510 g	0 ... 610 g	0 ... 610 g	0 ... 1010 g
Repeatability (s)	0.0008 g/0.003 g	0.001 g	0.001 g/0.003 g	0.0015 g
Linearity ¹⁾	±0.002 g/±0.005 g	±0.002 g	±0.002 g/±0.005 g	±0.003 g
Stabilization time (typical)	1...2 s	1...3 s	1...3 s	2...5 s
Adjustment • with internal weight • with external weights ⁴⁾	internal, fully automatic motorized initiation (FACT) test possibility for checking the sensitivity 200/300/400/500 g ⁴⁾ 300/400/500/600 g ⁴⁾ 200/300/400/500/600 g ⁴⁾ 500/600/700/800/900/1000 g ⁴⁾			
Sensitivity • Temperature drift ^{1) 2)} • Long-term drift ^{1) 3)}	±3 ppm/°C ±0.0015 %	±3 ppm/°C ±0.0015 %	±3 ppm/°C ±0.0015 %	±3 ppm/°C ±0.0015 %
Weighing pan	128x128 mm			
All-purpose draft shield (glass)	standard			
Effective height above pan	137 mm			
Dimensions (w/h/d)	226/239/360 mm			
Net weight	4.7 kg	5.5 kg		

¹⁾ In the temperature range 15 ... 30 °C

²⁾ 1 ppm = 1/1000000 (referred to the current weight display)

³⁾ Sensitivity deviation/year after first-time startup with self-calibration FACT switched on

⁴⁾ not allowed with certified versions

*) Production phaseout form 04/2001

Technical data	PG802-S	PG2002-S	PG2002-S Delta Range®
Readability	0.01 g	0.01 g	0.01 g/0.1 g
Maximum capacity	810 g	2100 g	400 g/2100 g
Taring range	0 ... 810 g	0 ... 2100 g	0 ... 2100 g
Repeatability (s)	0.008 g	0.008 g	0.008 g/0.03 g
Linearity ¹⁾	±0.01 g	±0.02 g	±0.02 g/±0.05 g
Stabilization time (typical)	1...2 s	1...2 s	1...2 s
Adjustment • with internal weight • with external weights ⁴⁾	internal, fully automatic motorized initiation (FACT) test possibility for checking the sensitivity 400/500/600/700/800 g ⁴⁾ 500/1000/1500/2000 g ⁴⁾ 500/1000/1500/2000 g ⁴⁾		
Sensitivity • Temperature drift ^{1) 2)} • Long-term drift ^{1) 3)}	±6 ppm/°C ±0.0050 %	±5 ppm/°C ±0.0050 %	±3 ppm/°C ±0.0030 %
Weighing pan	165x165 mm		
All-purpose draft shield (glass)	optional		
Effective height above pan	–		
Dimensions (w/h/d)	226/95/360 mm		
Net weight	5.5 kg		

Technical data	PG4002-S	PG4002-S DeltaRange®	PG5002-S *)
Readability	0.01 g	0.01 g/0.1 g	0.01 g
Maximum capacity	4100 g	800 g/4100 g	5100 g
Taring range	0 ... 4100 g	0 ... 4100 g	0 ... 5100 g
Repeatability (s)	0.008 g	0.008 g/0.03 g	0.008 g
Linearity ¹⁾	±0.02 g	±0.02 g/±0.05 g	±0.02 g
Stabilization time (typical)	1...2.5 s	1...2 s	1...2 s
Adjustment • with internal weight • with external weights ⁴⁾	internal, fully automatic motorized initiation (FACT) test possibility for checking the sensitivity 2/3/4 kg ⁴⁾ 1/2/3/4 kg ⁴⁾ 2/3/4/5 kg ⁴⁾		
Sensitivity • Temperature drift ^{1) 2)} • Long-term drift ^{1) 3)}	±3 ppm/°C ±0.0030 %	±3 ppm/°C ±0.0030 %	±3 ppm/°C ±0.0030 %
Weighing pan	165x165 mm		
All-purpose draft shield (glass)	optional		
Effective height above pan	–		
Dimensions (w/h/d)	226/95/360 mm		
Net weight	5.5 kg		

¹⁾ In the temperature range 15 ... 30 °C

²⁾ 1 ppm = 1/1 000 000 (referred to the current weight display)

³⁾ Sensitivity deviation/year after first-time startup with self-calibration FACT switched on

⁴⁾ not allowed with certified versions

*) Production phaseout form 04/2001

Technical data	PG5002-S *) Delta Range®	PG6002-S	PG6002-S DeltaRange®	PG3001-S certified
Readability	0.01 g/0.1 g	0.01 g	0.01 g/0.1 g	0.1 g
Maximum capacity	1000 g/5100 g	6100 g	1200 g/6100 g	3100 g
Taring range	0 ... 5100 g	0 ... 6100 g	0 ... 6100 g	0 ... 3100 g
Repeatability (s)	0.008 g/0.03 g	0.01 g	0.01 g/0.03 g	0.05 g
Linearity ¹⁾	±0.02 g/±0.05 g	±0.02 g	±0.02 g/±0.05 g	±0.1 g
Stabilization time (typical)	1...2 s	1...2.5 s	1...2 s	1...2 s
Adjustment • with internal weight • with external weights ⁴⁾	internal, fully automatic motorized initiation (FACT) test possibility for checking the sensitivity 2/3/4/5 kg ⁴⁾ 3/4/5/6 kg ⁴⁾ 2/3/4/5/6 kg ⁴⁾ -			
Sensitivity • Temperature drift ^{1) 2)} • Long-term drift ^{1) 3)}	±3 ppm/°C ±0.0030 %	±3 ppm/°C ±0.0030 %	±3 ppm/°C ±0.0030 %	±3 ppm/°C ±0.0030 %
Weighing pan	165x165 mm			
All-purpose draft shield (glass)	optional			
Effective height above pan	-			
Dimensions (w/h/d)	226/95/360 mm			
Net weight	5.5 kg			

¹⁾ In the temperature range 15 ... 30 °C

²⁾ 1 ppm = 1/1 000 000 (referred to the current weight display)

³⁾ Sensitivity deviation/year after first-time startup with self-calibration FACT switched on

⁴⁾ not allowed with certified versions

*) Production phaseout form 04/2001

7.2 Dimensions

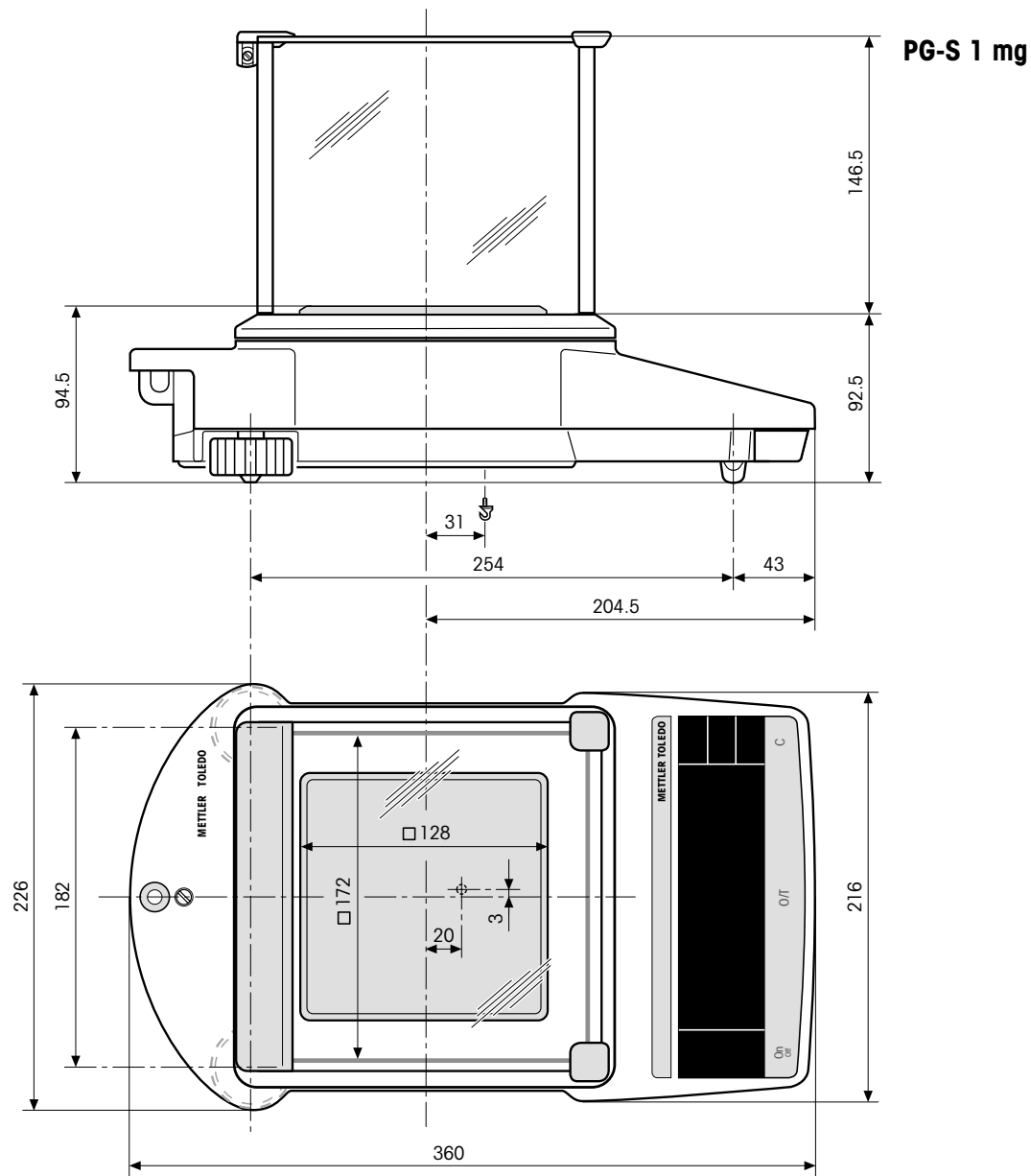

PG-S 10 mg

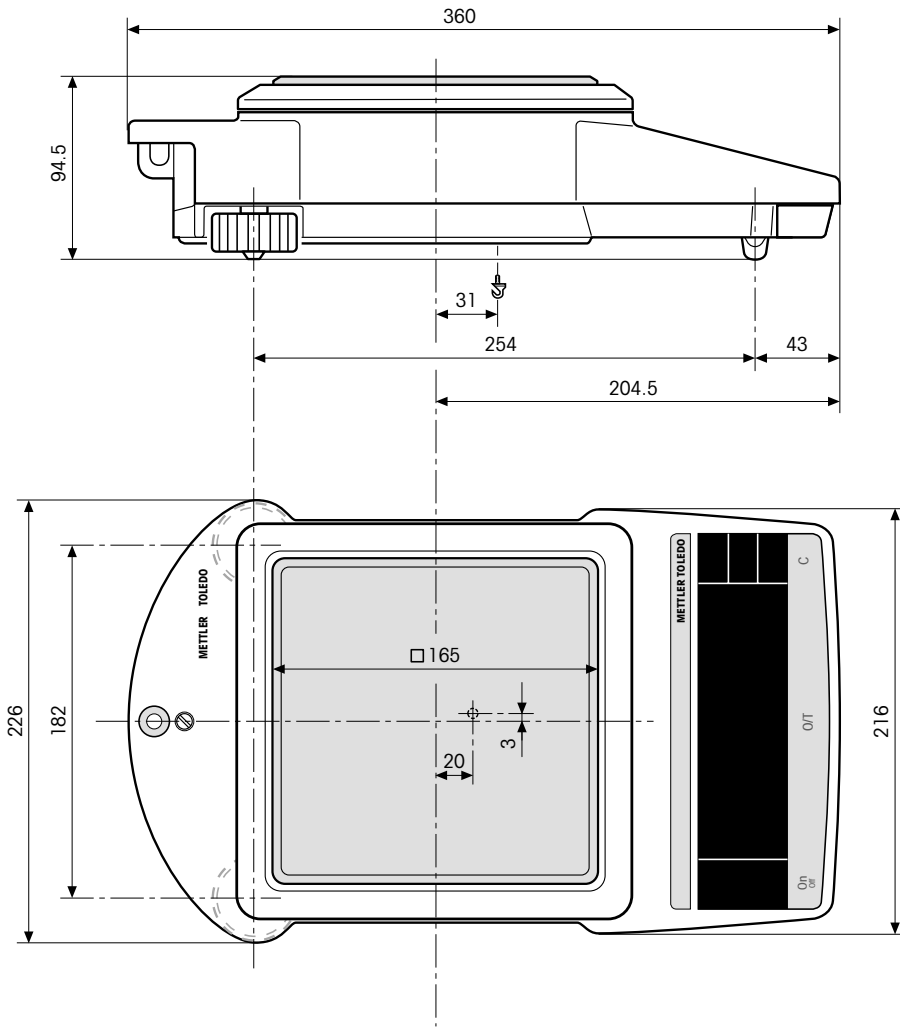

7.3 Optional equipment

With optional equipment from the METTLER TOLEDO product range, you can enhance the functionality of your PG-S balance. You have the following options available:

<p>Normal paper printers</p> <p>LC-P45 Printer: Printer with built-in applications (calibration and adjustment records conforming to GLP, statistical evaluations, totalization functions, etc.)</p> <p>LC-P43 Printer (only with LC option): Printer for recording the results</p> <p>GA42 Printer (only with RS232C): Printer for recording the results</p>	<p>229119</p> <p>229114</p> <p>51229170</p>
<p>Cables and cabling accessories</p> <p>RS9–RS25: (m/f), length 2 m</p> <p>RS9–RS9: (m/f), length 1 m</p> <p>RS9–RS9: (m/m), length 1 m</p>	<p>11101052</p> <p>11101051</p> <p>21250066</p>
<p>Antitheft device</p> <p>Steel cable with lock</p>	<p>590101</p>
<p>Density determination for PG-S with 1 mg readability</p> <p>Kit for density determination of solids</p> <p>Sinker for density determination of liquids (for use with density kit 225600)</p> <p>Application software for the density determination of solids, liquids and pasty substances (compatible with AG and PG-S)</p>	<p>225600</p> <p>210260</p> <p>238491</p>
<p>Draft shield</p> <p>All-purpose draft shield (free height 135 mm) for PG-S balances with 1 mg/10 mg readability</p> <p>Draft shield with movable glass doors (free height 265 mm) for PG-S balances 1 mg/10 mg readability</p>	<p>225269</p> <p>225500</p>
<p>LC option LocalCAN universal interface (LC-G)</p>	<p>11101055</p>
<p>Protective covers</p> <p>Protective cover for the entire PG-S balance (1 mg/10 mg readability)</p>	<p>11101338</p>
<p>R/G-M emulation</p> <p>Software cassette emulates interface commands and menu options of the PM balances. For the use of PG-S balances in systems together with PM balances.</p>	<p>21201308</p>

Transport case Offers space for PG-S balance with draft shield, printer, bench AC adapter, cables (power and interface) and LC option	11101050
Weights Available as OIML weights (E2 and F1, with certificate) or as adjustment (calibration) weights (not OIML): 20g, 50g, 100g and 200g	on request
This optional equipment can be used only with the LocalCAN universal interface!	
Auxiliary displays LC-AD: Auxiliary display, active, with bench stand	229140
LC-ADS: Auxiliary display, active, with balance stand for PG-S	229150
LC-PD: LCD auxiliary display, passive, with bench stand	229100
LC-PDS: LCD auxiliary display, passive, with balance stand for PG-S	229070
Foot switch LC-FS: Foot switch with adjustable function	229060
Cables and cabling accessories LC-RS25: Cable for the attachment of a printer or computer with RS-232C, 25-pin (m/f), such as IBM XT or compatibles	229050
LC-RS9: Cable for the attachment of a computer with RS-232C, 9-pin such as IBM AT or compatibles	229065
LC-CL: Cable for the attachment of a device with METTLER TOLEDO CL interface (5-pin)	229130
LC-LC03: Extension cable for LocalCAN, 0.3 m	239270
LC-LC2: Extension cable for LocalCAN, 2 m	229115
LC-LC5: Extension cable for LocalCAN, 5 m	229116
LC-LCT: T-piece for LocalCAN	229118
Bar-code reader: LC-BCR usable for operation of the application software Differential Weighing 238494	229145
Differential weighing Application software for differential weighing with bar-code reader LC-BCR Application software for differential weighing	238495 238494

Operating or installation instructions are enclosed with many of the options. For further information and for details on how to order the optional equipment, please contact your nearest METTLER TOLEDO dealer.

8. Appendix

8.1 Overview of menu

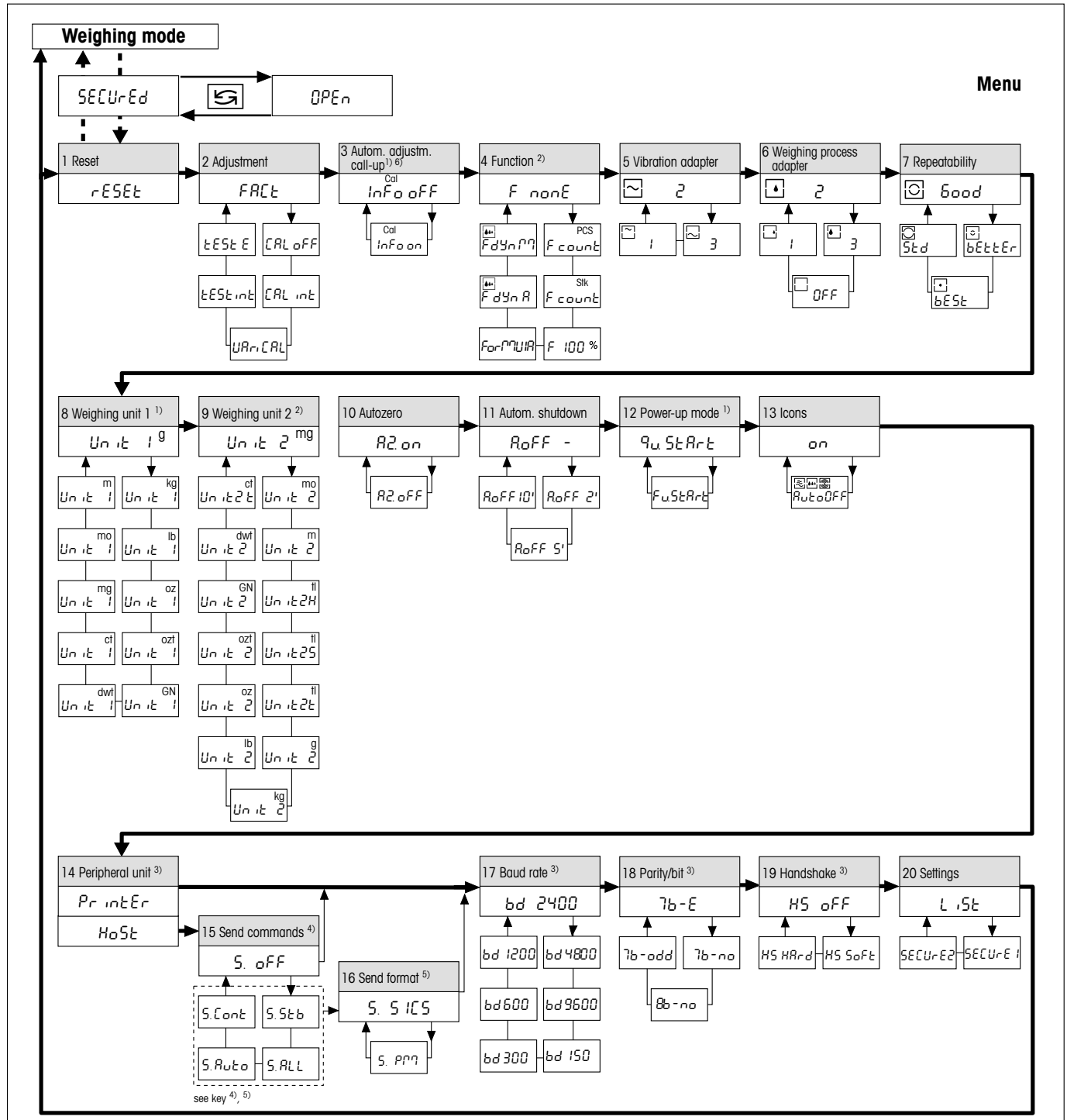

- 1) With certified balances, these menu options have a fixed setting and can not be changed.
- 2) With certified balances, only the weighing units/functions allowed by the respective national weights and measures legislation may be selected.
- 3) These menu options are shown only if your balance is equipped with an RS232C interface.
- 4) These menu options are shown only if "HoSt" has been selected in menu option 14.
- 5) These menu options are shown only if "S.oFF" has **not** been selected in menu option 15.
- 6) This menu option is shown only if "FACT" or "CAL oFF" has **not** been selected in menu option 2

8.2 Conversion table for weight units

Unit	Gram g	Milligram mg	Ounce oz (avdp)	Troy ounce ozt	Grain GN	Pennyweight dwt
1 g	1	1000	0.03527396	0.03215075	15.43236	0.6430149
1 mg	0.001	1	0.0000352740	0.0000321508	0.01543236	0.000643015
1 oz	28.34952	28349.52	1	0.9114585	437.500	18.22917
1 ozt	31.10347	31103.47	1.097143	1	480	20
1 GN	0.06479891	64.79891	0.002285714	0.002083333	1	0.04166667
1 dwt	1.555174	1555.174	0.05485714	0.05	24	1
1 ct/C.M.	0.2	200	0.007054792	0.006430150	3.086472	0.1286030
1 mo	3.75	3750	0.1322774	0.1205653	57.87134	2.411306
1 m	4.608316	4608.316	0.1625536	0.1481608	71.11718	2.963216
1 tl (HK)	37.429	37429	1.320269	1.203370	577.6178	24.06741
1 tl (SGP/Mal)	37.79937	37799.37	1.333333	1.215278	583.3334	24.30556
1 tl (Taiwan)	37.5	37500	1.322773	1.205653	578.7134	24.11306

Unit	Carat ct/C.M. (metr.) koiil	Momme mo	Mesghal m	Tael tl (Hong Kong)	Tael tl (Singapore) (Malaysia)	Tael tl (Taiwan)
1 g	5	0.2666667	0.216999	0.02671725	0.02645547	0.02666667
1 mg	0.005	0.000266667	0.000216999	0.0000267173	0.0000264555	0.0000266667
1 oz	141.7476	7.559873	6.151819	0.7574213	0.75	0.7559874
1 ozt	155.5174	8.294260	6.749423	0.8309993	0.8228570	0.8294261
1 GN	0.3239946	0.01727971	0.01406130	0.001731249	0.001714286	0.001727971
1 dwt	7.775869	0.4147130	0.3374712	0.04154997	0.04114285	0.04147131
1 ct/C.M.	1	0.05333333	0.04339980	0.005343450	0.005291094	0.005333333
1 mo	18.75	1	0.8137461	0.1001897	0.09920800	0.1
1 m	23.04158	1.228884	1	0.1231215	0.1219152	0.1228884
1 tl (HK)	187.1450	9.981068	8.122056	1	0.9902018	0.9981068
1 tl (SGP/Mal)	188.9968	10.07983	8.202425	1.009895	1	1.007983
1 tl (Taiwan)	187.5	10	8.137461	1.001897	0.9920800	1

8.3 SOP (Standard Operating Procedure)

In the documentation of a GLP test, the SOPs represent a relatively small but none the less very important part.

Practical experience has confirmed that SOPs produced in-house can be followed much better than those produced by an external, anonymous source.

In what follows , you will find a brief overview of the responsibilities in regard to SOPs, as well as a check list for the production of an SOP.

Responsibilities in regard to SOPs

Head of the inspection and test equipment	arranges the production of SOPs approves SOPs with date and signature
Test director	ensures that SOPs are available approves SOPs on behalf of the management
Personnel	follow the SOPs and other directives
GLP quality assurance	checks that valid SOPs are available checks that SOPs are followed checks whether and how modifications are documented

Check list for the production of SOPs

Administrative matters	Yes	No
1. Use of SOP blank forms		
2. Name of the inspection and test equipment		
3. Date (production date of the SOP)		
4. Filing identifier (code plan) for SOPs		
5. Number of pages (1 of n)		
6. Title		
7. Date of putting into force		
8. Modification information		
9. Names of people (departments) responsible for the implementation		
10. Date and signatures: a) author(s) b) checker c) person authorized for approval		
11. Distribution list		

Contents of the SOP	Yes	No
1. Introduction and aim		
2. Required material		
3. Description of the work steps		
4. Description of the documentation		
5. Data processing and evaluation		
6. Documentation, samples, etc. to be stored		
7. Archiving directions		

8.4 Index

A

Abort 46, 48, 50, 51, 53
Absolute weighing 24
AC adapter 2, 3, 8, 11, 56
Accuracy test 22
Adjustment mode 2, 3
Adjustment operation 12
Adjustment to acceleration due to gravity 12
Adjustment tolerance 45
Adjustment 12, 21, 57
Alphanumeric display 2, 3
Ambient conditions 12, 18, 21, 24, 52, 56
Animals 42
Antitheft device 62
Asterisk 43
Atmospheric humidity 56
Automatic adjustment call-up 22
Automatic shutdown 28
Automatic zero correction 28
Autozero 28
Auxiliary display 2, 3, 63

B

Backweighing 63
Bar-code reader 63
Baud rate 32
Below-the-balance weighings 44
Bottom view PG-S 2, 3
Brief keystroke 7

C

Cables 62, 63
Calculated result 2, 3, 43
Care 53
CE declaration of conformity 6

Checkweighing 24
Cleaning 53
Components 38, 40, 41
Computers 54
Connection socket 11
Conversion table for weight unit 65

D

Data transfer rate 32
Data 17
Decimal places 16
DeltaRange® 16
DeltaTrac 2, 3, 15, 37
Density determination 62
Deviation 51
Dimensions 57
Display test 13, 18, 29
Display 2, 3
Double beep 20
Draft shield cover 2, 3
Draft shield 2, 3, 62
Drafts 10
Drift 28
Dynamic weighing 23, 42

E

Equipment features 6
Error messages 52
Evaporation measurements 28

F

F count 35
FACT 12, 21, 45
Factory setting 21
Fine addition 24, 25
Fine range 16

Foot switch 63
Formula weighing 23, 38
Formula 38
Front view PG-S 2, 3
Function display 2, 3
Function 23, 35
Fuse 56

G

GLP 6, 12, 21, 54, 55, 62, 66
Good Laboratory Practice 6, 12
Graphic indicator 15

H

Handshake 18, 33
Hanger 44
Hazardous environment 8
Holder 11

I

Icons 30
Individual components 39
Interface 63
Internal adjustment 21
ISO 9001 6

K

Key designations 7
Keypad 8

L

Level control 2, 3
Leveling feet 10
Leveling foot 2, 3
Leveling the balance 10
Line voltage 8, 11
Linearity 57
List 33

LocalCAN universal interface 55, 62
Location change 10
Location selection 10

M

Maximum capacity 57
Menu options 19
Menu overview 64
Menu settings 33
Menu 18, 64

N

N total 40
Net total weight 40
Net weight 57

O

On and off switching 13
Open 34
Operating keys 2, 3
Optional equipment 56, 62
Overload 52
Overview 2, 3

P

Packaging 9
Parity/bit 32
Percent weighing 23, 37
Peripheral device 30, 32, 33, 54, 55
Piece counting 23, 35
Pin assignment 55
Power cable 11
Power supply 11, 36, 37, 44
Power-up mode 29
Printer 17, 33, 34, 46, 48, 50, 51, 54, 62
Printing out settings 33
Protective cover 54, 62
Putting into operation 9

Q

Quickstart 29

R

Readability 9, 16, 17, 57, 62

Rear view PG-S 2, 3

Record 12, 34, 40, 46, 48, 50, 51

Reference piece number 35, 52

Reference weight 35, 36, 37, 52

Reference 52

Repeatability 2, 3, 25, 52, 57

Repro-Set 25

Reset 21

Resolution of the weighing result 16

RS232C interface connection 2, 3

RS232C interface 54

S

Safety 7, 8

Saving settings 20

Secure 33

Self-test 11

Serial interface 32

Service 53

Settings 19

Short-form operating instructions 2, 3, 6, 8, 9

Software version 11

SOP 6, 12, 66

Speed 16

Stability detector 2, 3, 15, 25

Stability 43, 52

Stabilization time 57

Standard equipment 9

Standard Operating Procedure 6, 12, 66

Standby mode 13

Standby 28, 29

Steel cable antitheft device 2, 3

Sunlight 10

T

T total 40

Target weight 51

Taring range 14, 57

Taring 14

Technical data 56

Temperature fluctuations 10

Temperature 12, 21, 56

Test of the balance 22, 49, 50

Testing 12, 49

Thermal equilibrium 13

Tolerance marks 15

Tolerances 37

Total weight 39

Transport case 63

U

Underload 52

Unit 26, 27

Unstable weighing samples 23, 42

V

VariCal 21, 45, 47

Vibration adapter 2, 3, 24, 52

Voltage value 8

Voltage 11

W

Warm-up phase 12, 21

Warm-up time 13

Weighing container 14, 41

Weighing mode 19

Weighing pan 2, 3, 52, 57

Weighing process adapter 2, 3, 24, 42

Weighing result 17

Weighing unit 2, 3, 17, 26, 27

Weights 12, 21

Z

Zero point 28

**To protect your METTLER TOLEDO product's future:
METTLER TOLEDO Service assures the quality, measuring accuracy and
preservation of value of all METTLER TOLEDO products for years to come.
Please send for full details of our attractive terms of service.
Thank you.**

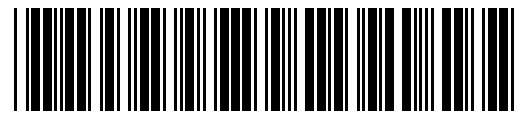

Subject to technical changes and to the availability
of the accessories supplied with the instrument.

© Mettler-Toledo GmbH 2001 11780160C Printed in Switzerland 0102/2.12

Mettler-Toledo GmbH, Laboratory & Weighing Technologies, CH-8606 Greifensee, Switzerland
Phone +41-1-944 22 11, Fax +41-1-944 30 60, Internet: <http://www.mt.com>