

# NewClassic Balances

## MS-S / MS-L Models

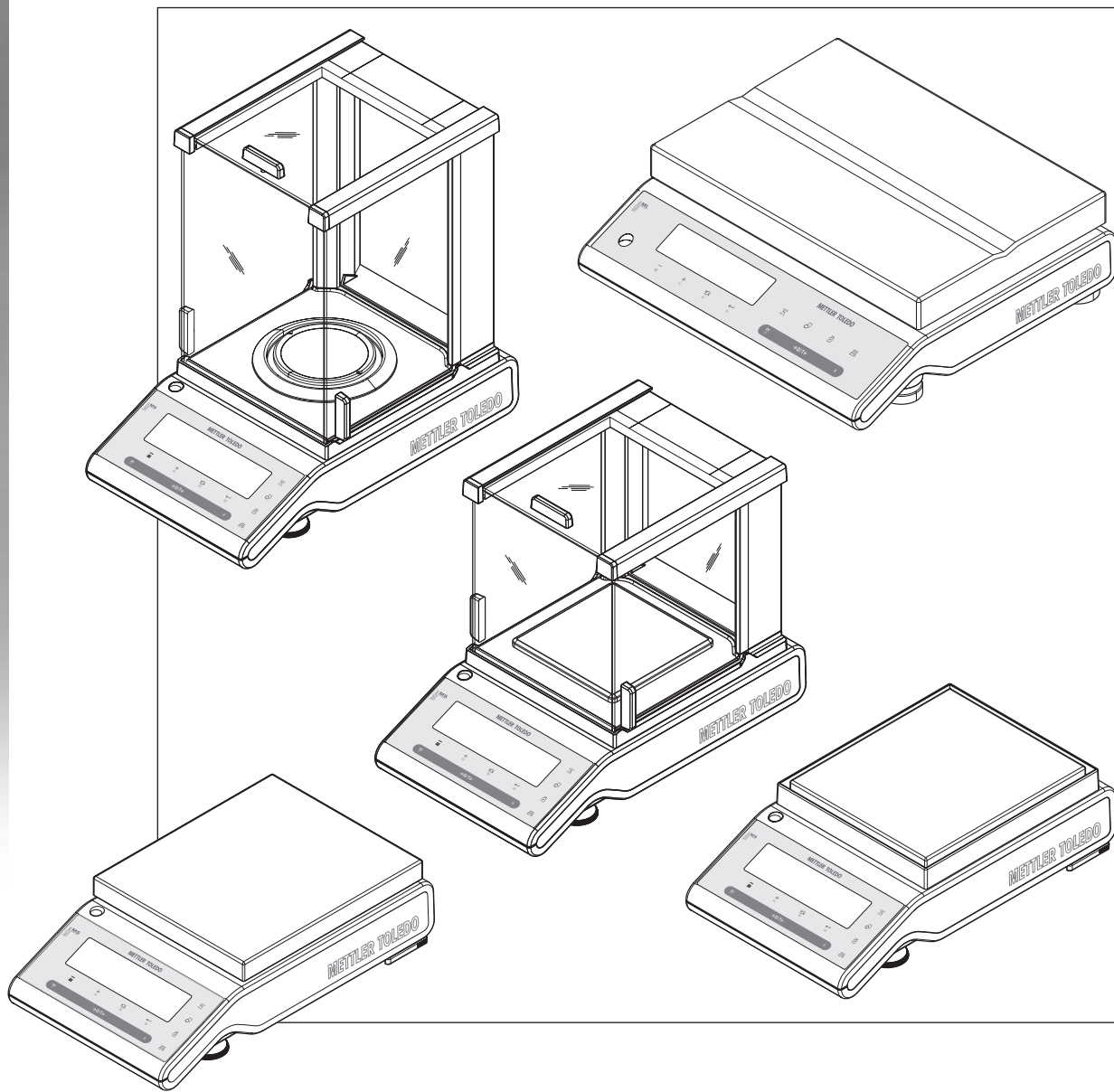

**METTLER TOLEDO**



---

**Table of contents**

<b>1</b>	<b>Introduction</b>		<b>7</b>
	1.1	Conventions and Symbols used in these Operating Instructions	7
<b>2</b>	<b>Safety Precautions</b>		<b>8</b>
<b>3</b>	<b>Overview</b>		<b>9</b>
	3.1	S Platform	9
	3.2	L Platform	10
	3.3	Operation Keys	11
	3.4	Display Panel	12
<b>4</b>	<b>Setting up the Balance</b>		<b>14</b>
	4.1	Unpacking and Delivery Inspection	14
	4.2	Installing the Components	15
	4.3	Selecting the Location and Leveling the Balance	17
	4.3.1	Selecting the Location	17
	4.3.2	Leveling the Balance	17
	4.4	Power Supply	18
	4.5	Battery Operation	19
	4.6	Transporting the Balance	19
	4.7	Weighing Below the Balance	19
	4.8	Adjustment (Calibration)	20
	4.8.1	Fully Automatic Adjustment FACT	20
	4.8.2	Manual Adjustment with Internal Weight	21
	4.8.3	Manual Adjustment with External Weight	21
<b>5</b>	<b>Weighing Made Simple</b>		<b>23</b>
	5.1	Switching the Balance On and Off	23
	5.2	Performing a Simple Weighing	24
	5.3	Zeroing / Taring	24
	5.4	METTLER TOLEDO DeltaRange Balances	25
	5.5	Switching Weight Units	25
	5.6	Recall / Recall Weight Value	25
	5.7	Weighing With the Weighing-in Aid	26
	5.8	Print / Transmit Data	26
<b>6</b>	<b>The Menu</b>		<b>27</b>
	6.1	What is in the Menu	27
	6.2	Menu Operation	28
	6.3	Description of Menu Topics	29
	6.3.1	Menu Mode	30
	6.3.2	Basic Menu	30
	6.3.3	Advanced Menu	31
	6.3.4	Interface Menu	37
<b>7</b>	<b>Application "Piece Counting"</b>		<b>41</b>
<b>8</b>	<b>Application "Percent Weighing"</b>		<b>43</b>

---

---

<b>9</b>	<b>Application "Check Weighing"</b>	<b>45</b>
<b>10</b>	<b>Application "Statistics"</b>	<b>47</b>
<b>11</b>	<b>Application "Formulation" (Net Total Formulation)</b>	<b>49</b>
<b>12</b>	<b>Application "Totaling"</b>	<b>51</b>
<b>13</b>	<b>Application "Dynamic Weighing"</b>	<b>53</b>
<b>14</b>	<b>Application "Multiplication Factor Weighing"</b>	<b>55</b>
<b>15</b>	<b>Application "Routine Test"</b>	<b>57</b>
<b>16</b>	<b>Application "Diagnostics"</b>	<b>60</b>
	16.1 Repeatability Test	60
	16.2 Display Test	61
	16.3 Key Test	61
	16.4 Motor Test	62
	16.5 Balance History	63
	16.6 Calibration History	64
	16.7 Balance Information	65
	16.8 Service Provider Information	66
<b>17</b>	<b>Error and Status Messages</b>	<b>67</b>
	17.1 Error Messages	67
	17.2 Status Messages	67
<b>18</b>	<b>Cleaning and Service</b>	<b>69</b>
	18.1 Cleaning the Glass Draft Shield (0.1 mg and 1 mg Models)	69
<b>19</b>	<b>Interface Specification</b>	<b>72</b>
	19.1 RS232C Interface	72
	19.2 USB Device Interface	72
	19.3 MT-SICS Interface Commands and Functions	73
<b>20</b>	<b>Technical Data</b>	<b>76</b>
	20.1 General Data	76
	20.2 Model-Specific Data	77
	20.2.1 Balances with Readability of 0.1 mg, S Platform with Draft Shield	77
	20.2.2 Balances with Readability of 1 mg, S Platform with Draft Shield	77
	20.2.3 Balances with Readability of 0.01 g, S Platform	79
	20.2.4 Balances with Readability of 0.1 g, S Platform	80
	20.2.5 Balances with Readability of 0.1 g to 1 g, L Platform	81
	20.2.6 Balances with Readability of 2 g to 5 g, L Platform	83
	20.3 Dimensions	85
	20.3.1 Balances with Readability of 0.1 mg, S Platform With Draft Shield	85
	20.3.2 Balances with Readability of 1 mg, S Platform With Draft Shield	86
	20.3.3 Balances with Readability of 0.01 g, S Platform	87
	20.3.4 Balances with Readability of 0.1 g, S Platform	88
	20.3.5 Balances with Readability of 0.1 g to 5 g, L Platform	89

---

---

<b>21</b>	<b>Accessories and Spare Parts</b>		<b>90</b>
		21.1 Accessories	90
		21.2 Spare Parts	93
<b>22</b>	<b>Appendix</b>		<b>95</b>
		22.1 Conversion Table for Weight Units	95
<b>23</b>	<b>Index</b>		<b>96</b>

---



# 1 Introduction

Thank you for choosing a METTLER TOLEDO balance.

The precision balances of the NewClassic line combine a large number of weighing possibilities with easy operation.

These operating instructions apply to all balance models MS-S and MS-L in the NewClassic line. However, the different models have different characteristics regarding equipment and performance. Special notes in the text indicate where this makes a difference to operation.

## 1.1 Conventions and Symbols used in these Operating Instructions

Key designations are indicated by double angular parantheses (e.g. «»).



This symbol indicates press key briefly (less than 1.5 s).



This symbol indicates press and hold key down (longer than 1.5 s).



This symbol indicates a flashing display.



This symbol indicates an automatic sequence.



These symbols indicate safety notes and hazard warnings which, if ignored, can cause personal danger to the user, damage to the balance or other equipment, or malfunctioning of the balance.

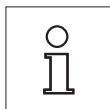

This symbol indicates additional information and notes. These make working with your balance easier, as well as ensuring that you use it correctly and economically.

## 2 Safety Precautions

Always operate and use your balance only in accordance with the instructions contained in this manual. The instructions for setting up your new balance must be strictly observed.

**If the balance is not used according to the manufacturer's Operating Instructions, protection of the balance may be impaired.**



It is not permitted to use the balance in hazardous environments.



Use the MSxxKLIP balance model with Protection Class IP65 if: the balance is used in wet areas, wet cleaning is necessary or the balance is used in a dusty environment. Even with Protection Class IP65. Never flood the balance or immerse it in liquid.

**All other balance models may only be used in dry rooms.**



Use only the Universal AC adapter delivered with your balance.

The L platform has a built-in power supply unit. Hazard of electric shock if the power cable is damaged! Check the power cable for damage regularly. Unplug the power cord immediately if the power cable is damaged.



Do not use sharply pointed objects to operate the keyboard of your balance! Although your balance is very ruggedly constructed, it is nevertheless a precision instrument. Treat it with corresponding care.

Do not open the balance: It does not contain any parts which can be maintained, repaired, or replaced by the user. If you ever have problems with your balance, contact your METTLER TOLEDO dealer.

Use only balance accessories and peripheral devices from METTLER TOLEDO; they are optimally adapted to your balance.



### Disposal

In conformance with the European Directive 2002/96/EC on Waste Electrical and Electronic Equipment (WEEE) this device may not be disposed of in domestic waste. This also applies to countries outside the EU, per their specific requirements.

Please dispose of this product in accordance with local regulations at the collecting point specified for electrical and electronic equipment. If you have any questions, please contact the responsible authority or the distributor from which you purchased this device. Should this device be passed on to other parties (for private or professional use), the content of this regulation must also be related.

Thank you for your contribution to environmental protection.



### 3 Overview

#### 3.1 S Platform

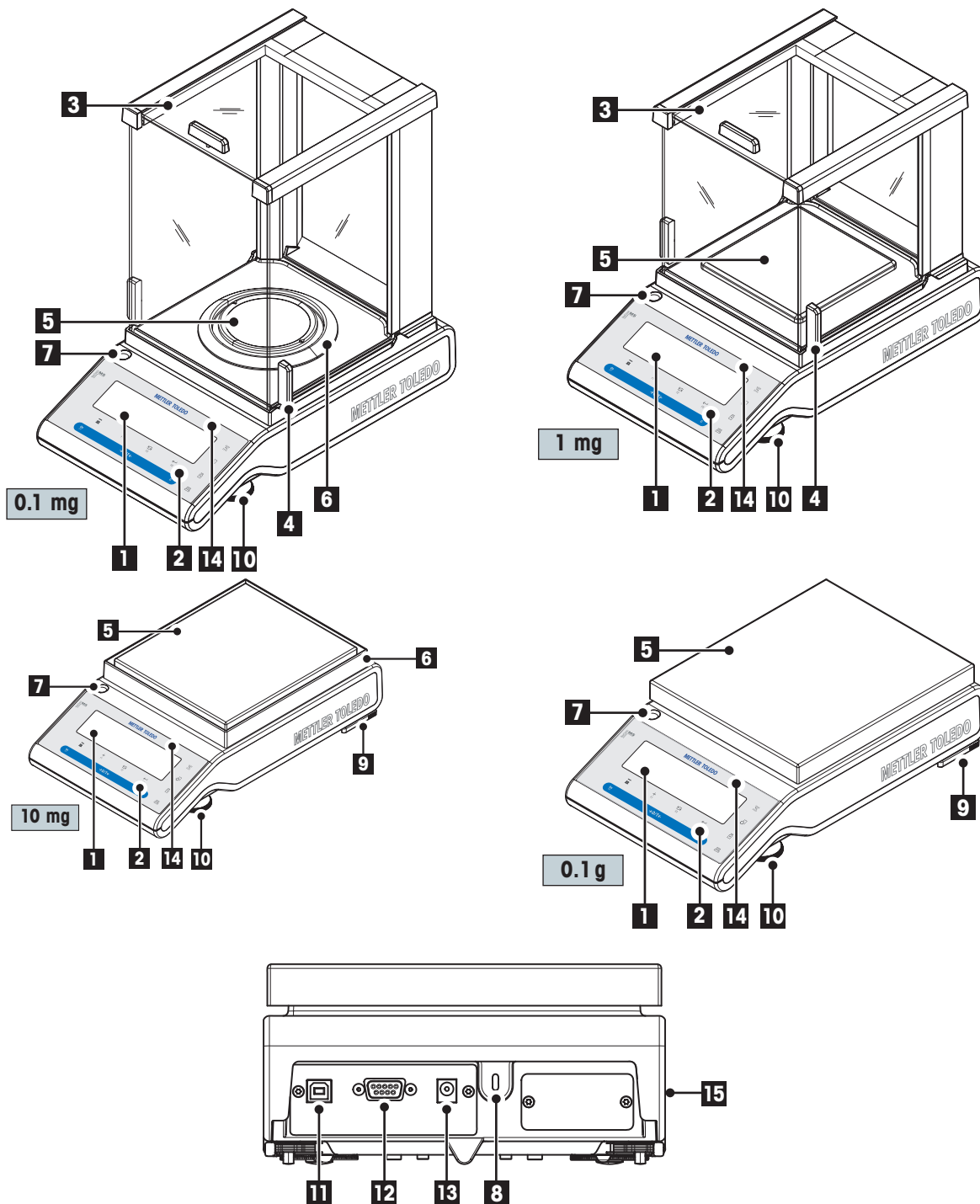

Name and Function of Components	
1	Display
9	Safety feet (with 10 mg, 0.1 g S series models)

Name and Function of Components			
2	Operation keys	10	Leveling foot
3	Glass draftshield	11	USB device interface
4	Handle for operation of the draft-shield door	12	RS232C serial interface
5	Weighing pan	13	Socket for AC Adapter
6	Draft shield element	14	Model sticker (with approved models only)
7	Level indicator	15	Product label
8	Kensington slot for anti-theft purposes		

### 3.2 L Platform

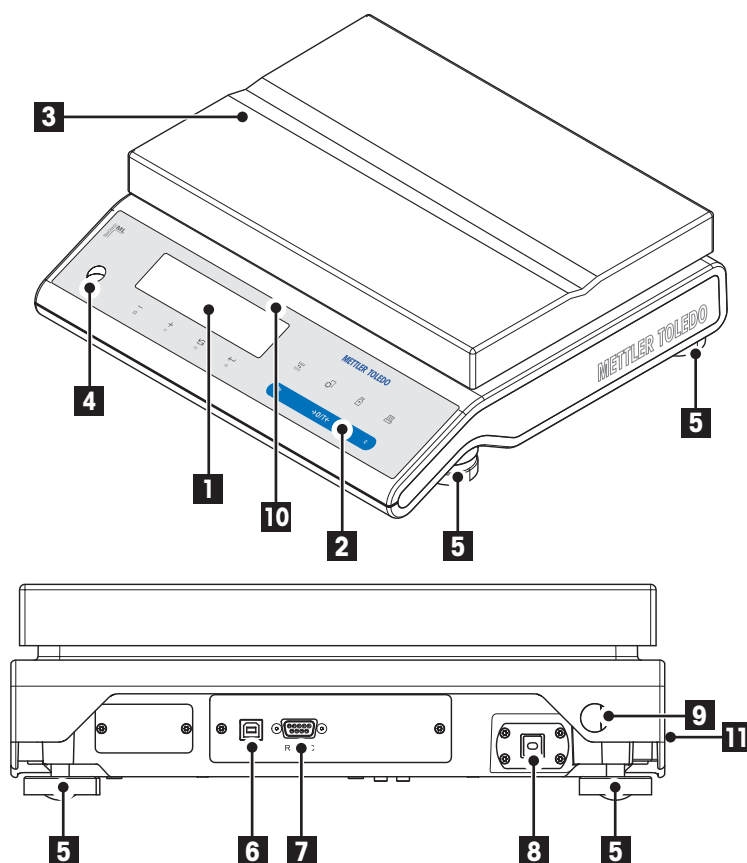





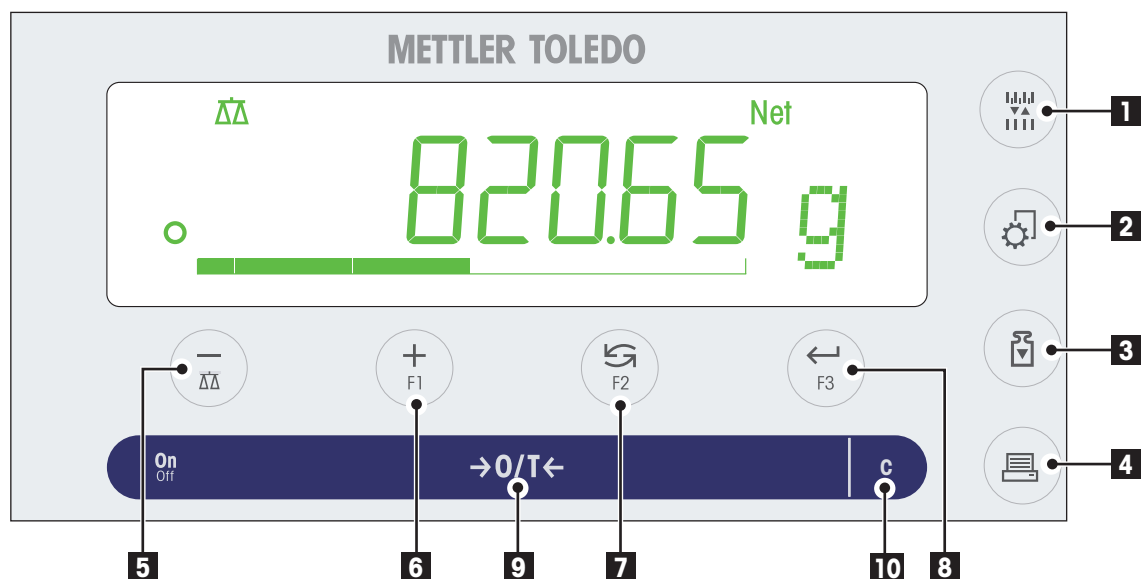



Name and Function of Components			
1	Display	7	RS232C serial interface
2	Operation keys	8	Power cord with country-specific plug
3	Weighing pan	9	Security slot for anti-theft purposes
4	Level indicator	10	Model sticker (with approved models only)
5	Leveling foot	11	Product label
6	USB device interface		

### 3.3 Operation Keys



#### Key Functions







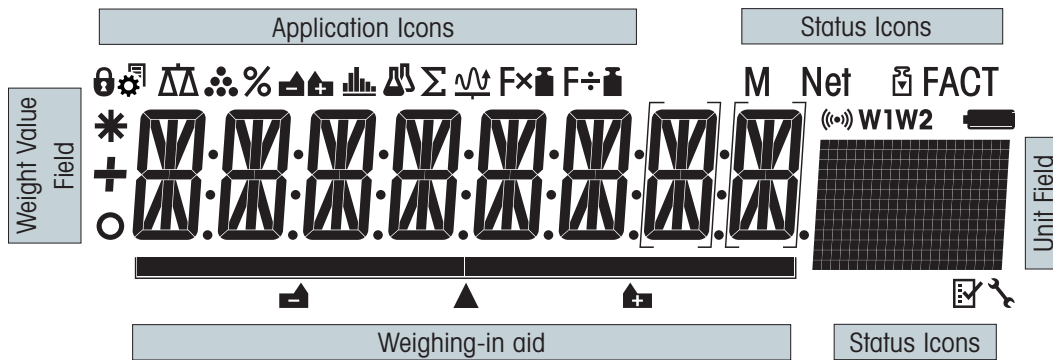

No.	Key	Press briefly (less than 1.5 s) 	Press and hold (longer than 1.5 s) 
1		<ul style="list-style-type: none"> <li>To change display resolution (1/10d function) while application is running</li> </ul>	no function
2		<ul style="list-style-type: none"> <li>Enter and leave menu (Parameter settings)</li> </ul>	no function
3		<ul style="list-style-type: none"> <li>Execute predefined adjusting (calibration) procedure</li> </ul>	no function
4		<ul style="list-style-type: none"> <li>Printout display value</li> <li>Printout active user menu settings</li> <li>Transfer data</li> </ul>	no function
5		<ul style="list-style-type: none"> <li>To navigate back (scroll up) within menu topics or menu selections (instead of using key no.7)</li> <li>Decrease (numerical) parameters within menu and in applications</li> </ul>	<ul style="list-style-type: none"> <li>To select the weighing application</li> </ul>
6		<ul style="list-style-type: none"> <li>To navigate forth (scroll down) within menu topics or menu selections</li> <li>Increase (numerical) parameters within menu and in applications</li> </ul>	<ul style="list-style-type: none"> <li>To select assigned F1 application and entering the parameter settings of application.</li> <li>Default F1 application assignment: Piece counting</li> </ul>

No.	Key	Press briefly (less than 1.5 s)	Press and hold (longer than 1.5 s)
7		<ul style="list-style-type: none"> <li>With entries: scroll down</li> <li>To navigate through menu topics or menu selections</li> <li>To toggle between unit 1, recall value (if selected), unit 2 (if different from unit 1) and the application unit (if any)</li> </ul>	<ul style="list-style-type: none"> <li>To select assigned F2 application and entering the parameter settings of application.</li> <li>Default F2 application assignment: Percent weighing</li> </ul>
8		<ul style="list-style-type: none"> <li>To enter and leave menu selection (from / to menu topic)</li> <li>To enter application parameter and switch to next parameter</li> <li>To store parameter</li> </ul>	<ul style="list-style-type: none"> <li>To select assigned F3 application and entering the parameter settings of application.</li> <li>Default F3 application assignment: Checkweighing</li> </ul>
9		<ul style="list-style-type: none"> <li>Switch on</li> <li>Zero/Tare</li> </ul>	<ul style="list-style-type: none"> <li>Switch off</li> </ul>
10	<b>C</b>	<ul style="list-style-type: none"> <li>Cancel and to leave menu without saving (one step back in the menu).</li> </ul>	no function

### 3.4 Display Panel

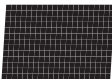

Application Icons			
	Menu locked		Application "Statistics"
	Settings activated		Application "Formulation / Net-Total"
	Application "Weighing"		Application "Totaling"
	Application "Piece counting"		Application "Dynamic weighing"
	Application "Percent weighing"		Application "Multiplication factor"
	Application "Check weighing"		n.a.
Status Icons			
<b>M</b>	Indicates stored value (Memory)		Service reminder
<b>Net</b>	Indicates Net weight values		Acoustic feedback for pressed keys activated
	Adjustments (calibration) started	<b>W1</b>	Weighing range 1 (Dual Range models only)
<b>FACT</b>	FACT activated	<b>W2</b>	Weighing range 2 (Dual Range models only)

Status Icons						
	Applications "Diagnostics" and "Routine Test"		Charge of battery: full, 2/3, 1/3, discharged (Battery operated models only)			
Weight Value Field and Weighing-in aid						
	Indicates negative values		Brackets to indicate uncertified digits (approved models only)			
	Indicates unstable values		Marking of nominal or target weight			
	Indicates calculated values		Marking of tolerance limit T+			
			Marking of tolerance limit T-			
Unit Field						
	<b>g</b>	gram	<b>ozt</b>	troy ounce	<b>tls</b>	Singapore taels
	<b>kg</b>	kilogram	<b>GN</b>	grain	<b>tlt</b>	Taiwan taels
	<b>mg</b>	miligram	<b>dwt</b>	pennyweight	<b>tola</b>	tola
	<b>ct</b>	carat	<b>mom</b>	momme	<b>bath</b>	bath
	<b>lb</b>	pound	<b>msg</b>	mesghal		
	<b>oz</b>	ounze	<b>tlh</b>	Hong Kong taels		

## 4 Setting up the Balance



The balance must be disconnected from the power supply when carrying out all setup and mounting work.

### 4.1 Unpacking and Delivery Inspection

- a) Open the packaging and carefully remove all components.
- b) Check the delivered items.

The standard scope of delivery contains the following items:

Components		S platform				L platform	
		0.1 mg	1 mg	0.01 g	0.1 g	0.1g/1g	2g/5g
Draft shield	237 mm	✓	–	–	–	–	–
	165 mm	–	✓	–	–	–	–
Weighing pan with pan support	Ø 90 mm	✓	–	–	–	–	–
	127 x 127 mm	–	✓	–	–	–	–
	170 x 200 mm	–	–	✓	–	–	–
	190 x 226 mm	–	–	–	✓	–	–
	246 x 351 mm	–	–	–	–	✓	✓
Draft shield element		✓	–	✓	–	–	–
Pan support		✓	✓	✓	✓	–	–
Bottom plate		✓	✓	✓	–	–	–
Protective cover		✓	✓	✓	✓	✓	✓
Universal AC adapter (country specific)		✓	✓	✓	✓	–	–
Mounted country specific power cable		–	–	–	–	✓	✓
Operating instruction (this document)		✓	✓	✓	✓	✓	✓
Quick Guide		✓	✓	✓	✓	✓	✓
EC declaration of conformity		✓	✓	✓	✓	✓	✓

## 4.2 Installing the Components

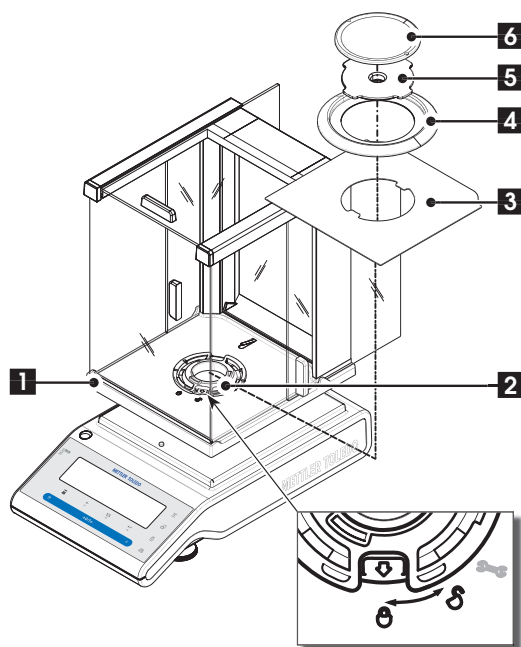

### Balances with readability of 0.1 mg, S platform with draft shield (237 mm)

Place the following components on the balance in the specified order:

**Note:** Push the side glass back as far as will go and grasp the draft shield (1) with both hands on the bars at the top.

- Turn draft shield lock (2) to position "U" (unlock).
- Place draft shield on the balance.
- Turn draft shield lock to "L" (lock) and place bottom plate (3).
- Place draft shield element (4) and weighing pan (6) with pan support (5).

**Note:** Cleaning the draft shield see section "Maintenance and cleaning".

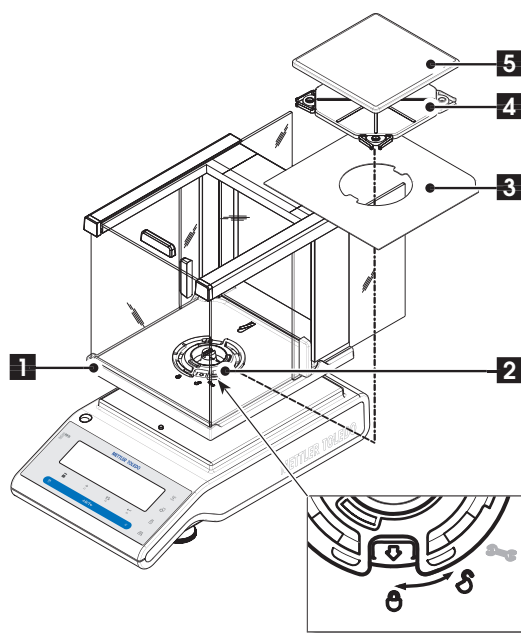

### Balances with readability of 1 mg, S platform with draft shield (165 mm)

Place the following components on the balance in the specified order:

**Note:** Push the side glass back as far as will go and grasp the draft shield (1) with both hands on the bars at the top.

- Turn draft shield lock (2) to position "U" (unlock).
- Place draft shield on the balance.
- Turn draft shield lock to "L" (lock) and place bottom plate (3).
- Place weighing pan (5) with pan support (4).

**Note:** Cleaning the draft shield see section "Maintenance and cleaning".

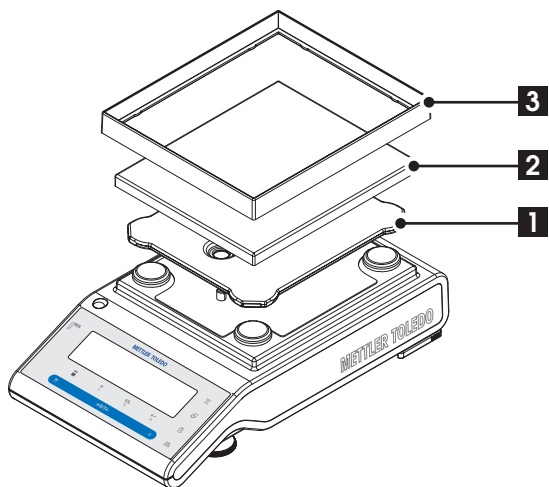

**Balances with readability of 10 mg, S platform**

Place the following components on the balance in the specified order:

- Pan support (1)
- Weighing pan (2)
- Draft shield element (3)

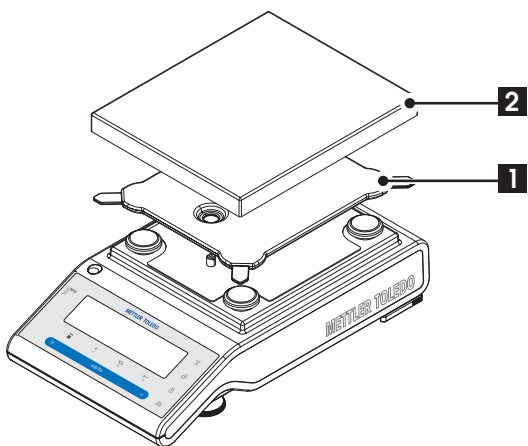

**Balances with readability of 0.1 g, S platform**

Place the following components on the balance in the specified order:

- Pan support (1)
- Weighing pan (2)

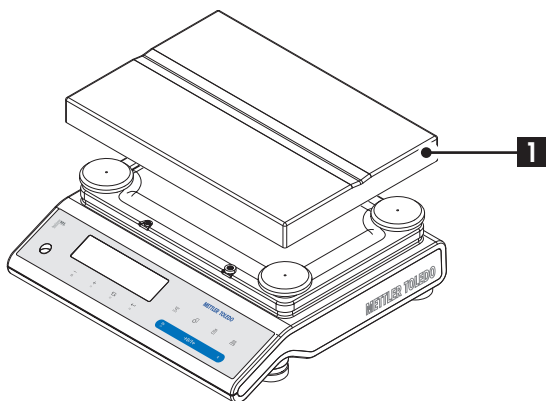

**Balances with readability to 1 g, L platform**

Place the weighing pan (1) on the balance.



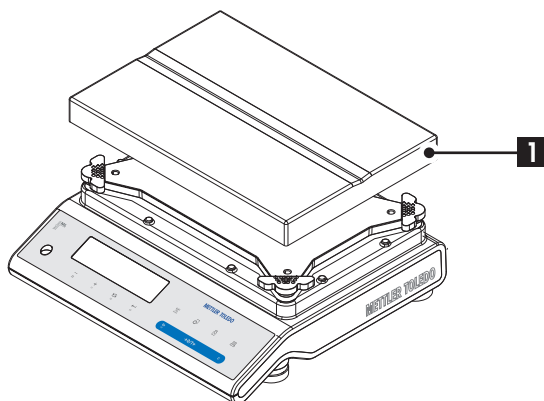

### Balances with readability from 2 g, L platform

Place the weighing pan (1) on the balance.

## 4.3 Selecting the Location and Leveling the Balance

Your balance is a precision instrument and will thank you for an optimum location with high accuracy and dependability.

### 4.3.1 Selecting the Location

Select a stable, vibration-free position that is as horizontal as possible. The surface must be able to safely carry the weight of a fully loaded balance.

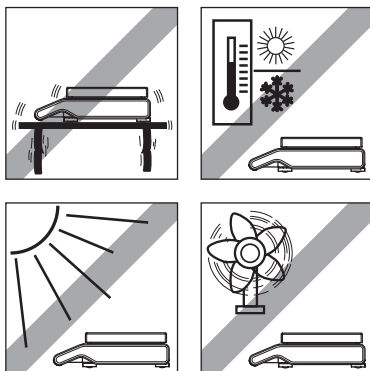

Observe ambient conditions (see Technical Data).

Avoid the following:

- Direct sunlight
- Powerful drafts (e.g. from fans or air conditioners)
- Excessive temperature fluctuations

### 4.3.2 Leveling the Balance

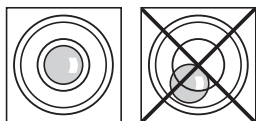

The balances have a level indicator and two (S Platform) or four (L Platform) adjustable leveling feet to compensate for slight irregularities in the surface of the weighing bench. The balance is exactly horizontal when the air bubble is in the middle of the level glass.

**Note:** The balance should be leveled and adjusted each time it is moved to a new location.

#### Balances with S platform and readability of 0.1 mg and 1 mg

Adjust the two leveling feet appropriately until the air bubble comes to rest exactly in the middle of the glass:

Air bubble at "12 o'clock" turn both feet clockwise

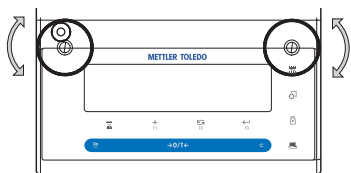

Air bubble at	"3 o'clock"	turn left foot clockwise, right foot counterclockwise
Air bubble at	"6 o'clock"	turn both feet counterclockwise
Air bubble at	"9 o'clock"	turn left foot counterclockwise, right foot clockwise

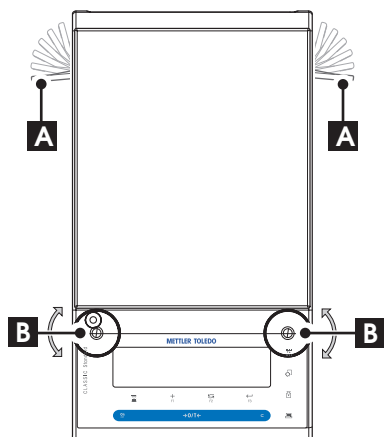

**Balances with S platform and readability of 10 mg and 0.1 g**

- a) Remove the clamps (A) for the safety feet by turning them outwards. **Note:** Turn the clamps (A) outwards as far as they will go (~ 90°), so that the safety feet can move freely.
- b) Now level the balance by turning both leveling screws (B) until the air bubble is in the inner circle of the level indicator (see procedure above).
- c) Secure the safety feet by turning the clamps (A) inwards as far as they will go.

**Balances with L platform**

Align the balance horizontally by turning the leveling screws of the balance housing until the air bubble is in the inner circle of the level indicator.

## 4.4 Power Supply

Your balance is supplied with an country-specific AC adapter or with a country-specific power cable. The power supply is suitable for all line voltages in the range: 100 - 240 VAC, 50/60 Hz (for exact specifications, see section "technical data").



First, check the local line voltage is in the range 100 - 240 VAC, 50/60 Hz and whether the power plug fits your local power supply connection. **If this is not the case, on no account connect the balance or the AC adapter to the power supply**, but contact the responsible METTLER TOLEDO dealer.



**Important:** Guide the cables so that they cannot become damaged or interfere with the weighing process! Take care that the AC adapter cannot come into contact with liquids!

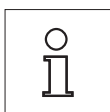

**Allow your balance to warm up for 30 minutes (0.1 mg models 60 minutes) to enable it to adapt itself to the ambient conditions.**

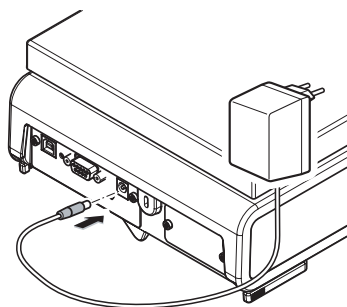

Connect the AC adapter to the connection socket on the back of your balance (see figure) and to the power line.

## 4.5 Battery Operation

Balances with a built-in rechargeable battery can, under normal operation conditions, work independently of the AC power line for about 8 hours. Immediately the AC power supply is interrupted e.g. by withdrawing the power cord plug or if there is a power failure, the balance switches automatically to battery operation. Once the AC power supply is restored, the balance reverts automatically to AC operation.

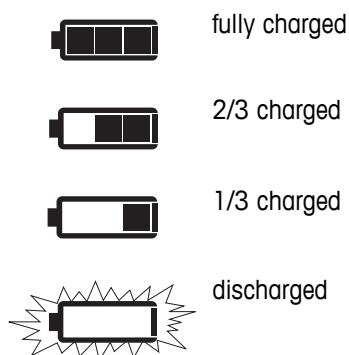

When the balance is operating on its batteries, the battery symbol in the display lights up. The number of segments that are lit is an indicator of battery condition (3 = fully charged, 0 = discharged). When the batteries are almost completely discharged, the battery symbol flashes.

Charging the built-in battery is indicated with filling up all 3 levels continuously. After the charging is finished the battery symbol is turned off. The battery is protected against overcharging, and the balance can therefore remain permanently connected with the AC power line.

**Note:** The built-in rechargeable battery can not be replaced by the user. Please contact METTLER TOLEDO customer Service.

## 4.6 Transporting the Balance

Switch off the balance and remove the power cable and any interface cable from the balance. Refer to the notes in Section "Selecting the location" regarding the choice of an optimal location.

### Transporting Over Short Distances



**For balances with a draft shield:** Observe the following instructions to transport your balance over a short distance to a new location: **Never lift the balance using the glass draft shield. The draft shield is not sufficient fastened to the balance.**

### Transporting Over Long Distances

If you would like to transport or send your balance over long distances, **use the complete original packaging.**

## 4.7 Weighing Below the Balance

The balances are equipped with a hanger for carrying out weighings below the work surface (weighing below the balance).



**Attention:**

- **Do not place the balance on the pan support location bolt** (0.1 mg and 1 mg models).
- Models with a glass draft shield: Carefully lift the draft shield from the weighing platform and put it aside.

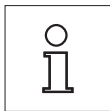

**Note:**

- For below-the-balance weighing with the L Platform models, you will need hook 11132565 from the accessories range.
- Weighing below the balance is not possible with "MS-KL" models.

**S Platform**

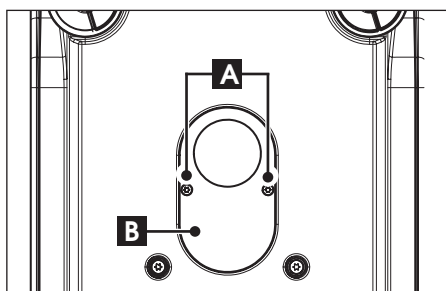

**L Platform**

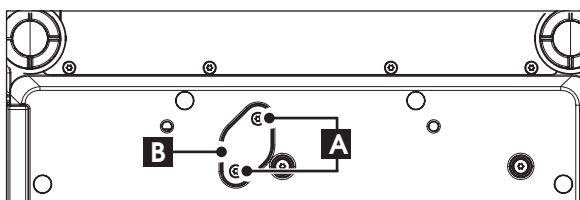

- Switch off the balance and remove the power cable and any interface cable from the balance.
- Remove the draft shield element (10 mg models).
- Remove the weighing pan and pan support.
- Remove the bottom plate and unlock the draft shield (models with draft shield).
- Remove the 2 screws (A) and the cover plate (B). The hanger is now accessible.
- Then turn the balance to its normal position and simply reinstall all components in the reverse order.

## 4.8 Adjustment (Calibration)



To obtain accurate weighing results, the balance must be adjusted to match the gravitational acceleration at its location. Adjusting is necessary:

- before the balance is used for the first time.
- at regular intervals during weighing service.
- after a change of location.

### 4.8.1 Fully Automatic Adjustment FACT

**Note:** On models with FACT only.

The **factory setting** is fully automatic adjustment **FACT** (Fully Automatic Calibration Technology) with the internal weight (see also section "The Menu"). In this setting, you have no need worry about adjusting your balance.

The balance adjusts itself automatically:

- after the warm-up phase on connection to the power supply.

- when a change in the ambient conditions, e.g. the temperature could lead to a noticeable deviation in the measurement.
- on a predefined time. (see menu topic "FACT")
- time interval. (with approved models)

## 4.8.2 Manual Adjustment with Internal Weight

**Note:** On models with internal weight only (see technical data).

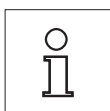

**To obtain accurate results, the balance must be connected to the power supply for approximately 30 minutes (0.1 mg balances 60 minutes) in order to reach operating temperature before adjusting.**

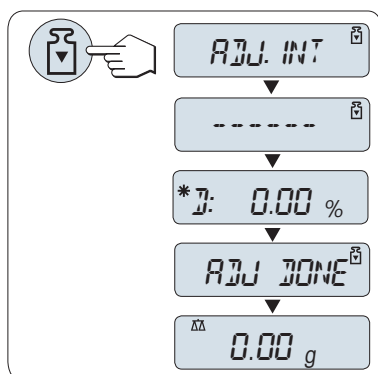

**Requirement:** To carry out this operation, in the menu topic "CAL" (Adjustment) of advanced menu "ADJ.INT" must be selected.

- Unload weighing pan
- Press «» to execute "Internal Adjustment".

The balance adjusts itself automatically. The adjusting is finished when the deviation and the message "ADJ DONE" appears briefly in the display. The balance returns to the last active application and is ready for operation.

**Sample adjustment printout using internal weight:**

```
| -- Internal adjustment - |
| 21.Jan. 2009      12:56 |
|                   |
| METTLER TOLEDO   |
|                   |
| Balance Type      MS4002S |
| SNR:              1234567890 |
|                   |
| Temperature       22.5 °C |
| Diff              0.001 % |
|                   |
| Adjustment done   |
| -----          |
|                   |
```

## 4.8.3 Manual Adjustment with External Weight

**Note:** Because of certification legislation, the approved models cannot be adjusted with an external weight.

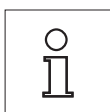

**To obtain accurate results, the balance must be connected to the power supply for approximately 30 minutes (0.1 mg balances 60 minutes) in order to reach operating temperature before adjusting.**

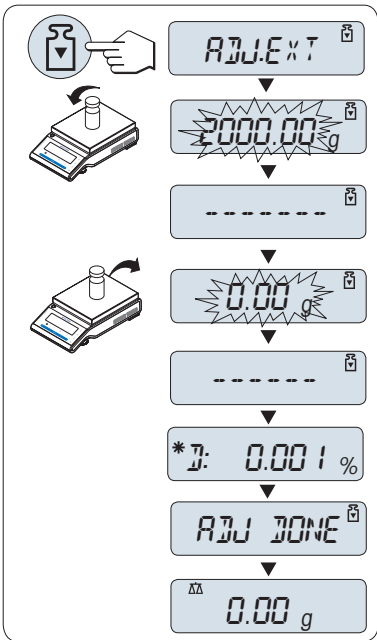

**Requirement:** To carry out this operation, in the menu topic "CAL" (Adjustment) " of advanced menuADJ.EXT" must be selected.

- a) Have required adjustment weight ready.
- b) Unload weighing pan.
- c) Press «» briefly to execute "External Adjustment". The required (pre-defined) adjustment weight value flashes in the display.
- d) Place adjustment weight in center of pan. The balance adjusts itself automatically.
- e) When "0.00 g" flashes, remove adjustment weight.

The adjusting is finished when the deviation value and the message "ADJ DONE" appears briefly in the display. The balance returns to the last active application and is ready for operation.

**Sample adjustment printout using external weight:**

```

| -- External adjustment - |
| 21.Jan. 2009      12:56 |
|
| METTLER TOLEDO
|
| Balance Type      MS4002S |
| SNR:              1234567890 |
|
| Temperature       22.5 °C |
| Nominal            4200.00 g |
| Actual            4199.99 g |
| Diff               0.001 % |
|
| Adjustment done
|
| Signature
| .....
| -----
    
```

## 5 Weighing Made Simple



This section shows you how to perform simple weighings and how you can accelerate the weighing process.

### 5.1 Switching the Balance On and Off

This section shows you how to perform simple weighings and how you can accelerate the weighing process.

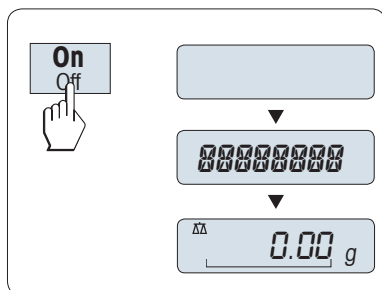

#### Switching On

- Remove any load from weighing pan.
- press the «**On**» key.

The balance performs a display test (all segments in the display light up briefly), "WELCOME", Software version, Maximum load and Readability appears briefly. (Startup "FULL" mode only)

The balance is ready for weighing or for operation with the last active application.

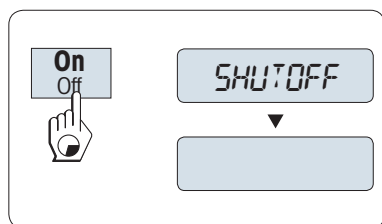

#### Switching Off

Press and hold the «**Off**» key until "SHUTOFF" appears on the display. Release the key.

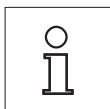

After it has been switched off, your balance is in the standby mode. The display shows date, time, maximum load and readability. As your balance needs no warm-up time in the standby mode and is immediately ready for weighing.

When Quickstart "QUICK" (Advanced menu, topic "STARTUP") is selected: If you wish to perform a weighing, you need now only place the sample on the weighing pan and the balance immediately displays the result. There is no need to switch it on with the «**On/Off**» key.

#### Note:

- Quickstart is not possible with approved balances.
- Standby mode is available by line powered balances only.

## 5.2 Performing a Simple Weighing

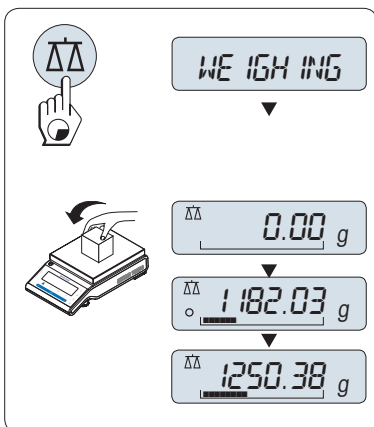

- If your balance is not in the weighing mode, press and hold the « $\Delta\Delta$ » key down until "WEIGHING" appears in the display. Release the key. Your balance is in the weighing mode and set to zero.
- Place weighing sample on the weighing pan.
- Wait until the instability detector "O" disappears and the stability beep sounds.
- Read the result.

## 5.3 Zeroing / Taring

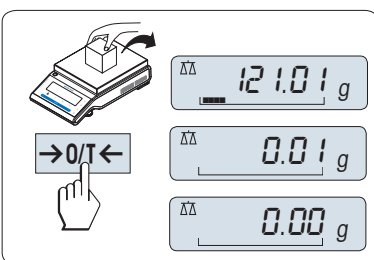

### Zeroing

- Unload the balance.
- Press « $\rightarrow$ 0/T $\leftarrow$ » to set the balance to zero. All weight values are measured in relation to this zero point (see menu topic "ZERO RNG").

**Note:** Use the « $\rightarrow$ 0/T $\leftarrow$ » zeroing key before you start with a weighing.

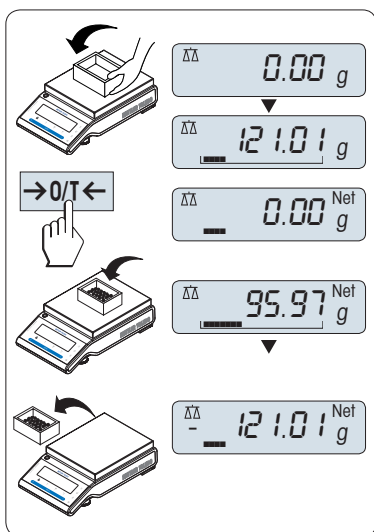

### Taring

If you are working with a weighing container, first set the balance to zero.

- Place empty container on the balance. The weight is displayed.
- Press « $\rightarrow$ 0/T $\leftarrow$ » to tare the balance.

"0.00 g" and "Net" appears in the display. "Net" indicates that all weight values displayed are net values.

### Note:

- If the container is removed from the balance, the tare weight will be shown as a negative value.
- The tare weight remains stored until the « $\rightarrow$ 0/T $\leftarrow$ » key is pressed again or the balance is switched off.
- With METTLER TOLEDO DeltaRange balances (see following section), the fine range with its 10 times smaller display increments (depends on the model) is available again after every taring operation.



## 5.4 METTLER TOLEDO DeltaRange Balances

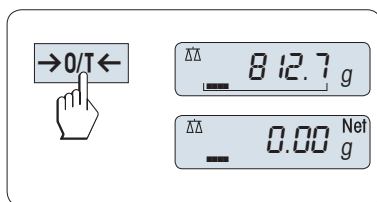

METTLER TOLEDO DeltaRange balances have a movable fine range with 10 times smaller display increments over their entire weighing range. In this fine range an additional decimal place always appears in the display.

The balance operates in the fine range

- after switching on.
- after every taring operation.

If the fine range is exceeded, the balance display automatically switches to coarser display increments.

## 5.5 Switching Weight Units

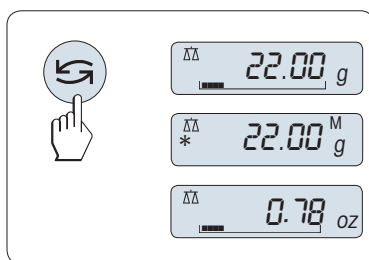

The «↻» key can be used at any time to toggle between weight unit "UNIT 1", "RECALL" value (if selected) and weight unit "UNIT 2" (if different from weight unit 2).

## 5.6 Recall / Recall Weight Value

Recall stores stable weights with an absolute display value bigger than 10d.

**Requirement:** The function "RECALL" must be activated in the menu.

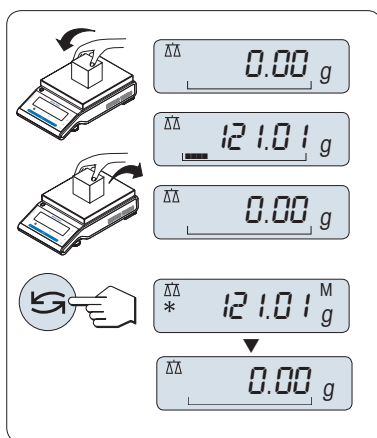

- Load weighing sample. The display shows weight value and stores stable value.
- Remove weighing sample. When the weight is removed the Display shows zero.
- Press The «↻» key. The display shows last stored stable weight value for 5 seconds together with asterisk (\*) and Memory (M) symbols. After 5 seconds the display goes back to zero. This can be repeated unlimited times.

### Delete last weight value

As soon a new stable weight value is displayed, the old recall value becomes replaced by the new weight value. When pressing the «→0/T←» key, the recall value is set to 0.

**Note:** If the power is switched off, the recall value is lost. The recall value can not be printed.

## 5.7 Weighing With the Weighing-in Aid



The weighing-in aid is a dynamic graphic indicator which shows the used amount of the total weighing range. You can thus recognize at a glance when the load on the balance approaches the maximum load.

## 5.8 Print / Transmit Data

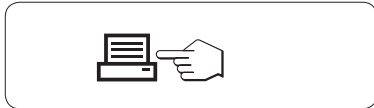

Pressing the «» key transmits the weighing results over the interface e.g. to a printer or a PC.

## 6 The Menu

### 6.1 What is in the Menu



The Menu allows you to match your balance to your specific weighing needs. In the menu you can change the settings of your balance and activate functions. The menu has 3 **modes** and contains 37 different **topics**, each of which allows you various **selection** possibilities.

**Note:** See Quick Guide for the graphical overview of the menu (Menu Map) with all setting possibilities.

#### Menu Mode "BASIC"

Topic	Description
DATE	Setting the current date.
TIME	Setting the current time.
UNIT 1	Specification of the 1st weight unit in which the balance should show the result.
UNIT 2	Specification of the 2nd weight unit in which the balance should show the result.
KEY BEEP	Setting the key beep level.
RESET	Call up of the factory settings.
SET MENU	Selection of the menu mode "BASIC", "ADVANCED", "INT.FACE" or "OFF".

#### Menu Mode "ADVANCED"

Topic	Description
ENVIRON.	Matching the balance to the ambient conditions.
CAL	Settings for the type of adjustment (calibration).
FACT	Settings for fully automatic balance adjustment based on a selected time.
FACT PRT.	Switching the automatic FACT printout on or off.
DATE	Setting the current date.
DATE.FORM	Setting the date format.
TIME	Setting the current time.
TIME.FORM	Preselection of the time format.
RECALL	Switching the application "Recall" for storing stable weights on or off.
UNIT 1	Specification of the 1st weight unit in which the balance should show the result.
UNIT 2	Specification of the 2nd weight unit in which the balance should show the result.
KEY BEEP	Setting the key beep level.
STAB.BEEP	Setting the stability beep level.
STARTUP	Setting the mode which the balance powers up (full or standby).
SHUTOFF	Setting the time after which the balance should be switched off automatically.
BCKLIGHT	Setting the time after which the display backlight should be switched off automatically.
DISPLAY	Adjusting the brightness and contrast of the display.
AUTOZERO	Switching the automatic zero correction (Autozero) on or off.
SERV.ICON	Switching the service icon (service reminder) on or off.
ZERO RNG	Setting the zero limit of the zero/tare key.
LANGUAGE	Setting the preferred language.
ASSIGN:F1	Selection of assigned F1 key application and entering their parameter settings.
ASSIGN:F2	Selection of assigned F2 key application and entering their parameter settings.
ASSIGN:F3	Selection of assigned F3 key application and entering their parameter settings.
DIAGNOSE	Starting a diagnostic application.

Topic	Description
RESET	Call up of the factory settings.
SET MENU	Selection of the menu mode "BASIC", "ADVANCED", "INT.FACE" or "OFF".

### Menu Mode "INT.FACE"

Topic	Description
RS232	Matching the serial interface RS232C to a peripheral unit.
BAUDRATE	Setting the transfer speed of the serial interface RS232C.
BIT/PAR.	Setting the character format (Bit/Parity) of the serial interface RS232C.
HD.SHAKE	Setting the transferprotocol (Handshake) of the serial interface RS232C.
RS E.O.L.	Setting the end of line format of the serial interface RS232C.
RS CHAR	Setting the char set of the serial interface RS232C.
USB	Matching the USB interface to a peripheral unit.
USB E.O.L.	Setting the end of line format of the USB interface.
USB CHAR	Setting the char set of the USB interface.
INTERVAL	Selection of the time which the balance started an automatic printout.
SET MENU	Selection of the menu mode "BASIC", "ADVANCED", "INT.FACE" or "OFF".

## 6.2 Menu Operation

In this Section you will learn how to work with the menu.

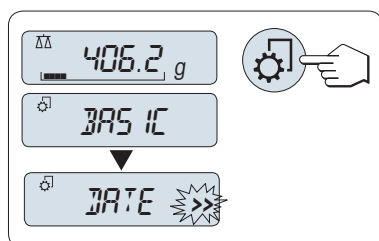



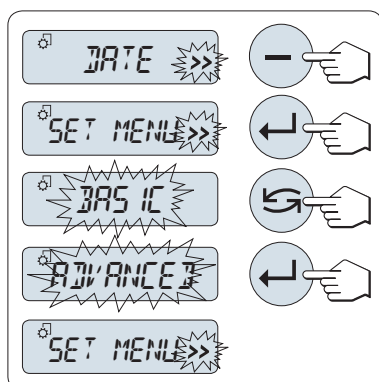

### Opening the Menu

Press the menu key «» briefly. The balance shows the current menu mode for 1 second and switches to the first menu topic.



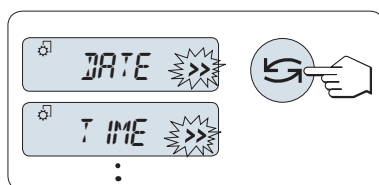

### Set Menu Mode

- Press «» key to select the topic "SET MENU". (Last Menu Topic. )
- Press «». The current menu mode appears.
- Press «» repeatedly to change menu mode. (scrolling down/up «+» / «-» keys)
- Press «» to confirm the selection.



### Select Menu Topic

Press «» briefly. The next menu topic appears in the display. Each time the «» or the «+» key is pressed, the balance switches to the next menu topic; the «-» key to the previous menu topic.

/&gt;

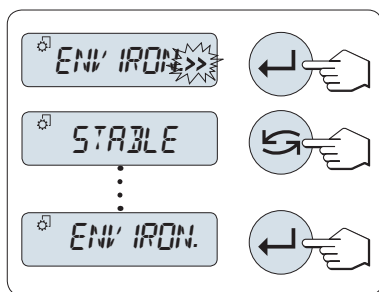

### Change Settings in a Selected Menu Topic

The ">>" flashing symbol in the display indicates selectable options available.

- Press «←». The display shows the current setting in the selected menu topic. Each time «↶» or «+» is pressed, the balance switches to the next selection; press «→» to the previous selection. After the last selection, the first is shown again.
- Press «←», the balance executes the selected setting and returns to the menu topic.

### Change Settings in a Submenu Selection

The same procedure as for menu topics.

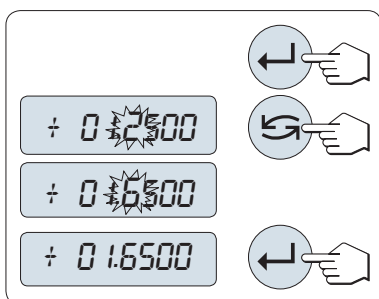

### Input Principle of Numerical Values

- Press «←» for input of numerical values.
- Press «↶» to select a digit or a value (depends on the application). The selected digit or the selected value is blinking.
- For changing digits or values, press «+» to scrolling up or «→» to scrolling down.
- Press «←» to confirm the input.

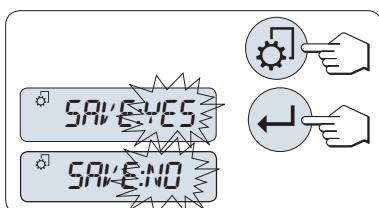

### Saving Settings and Closing the Menu

- Press «⚙» briefly to leave menu topic.
- Press «←» to execute "SAVE: YES". Changes are saved.
- Press «←» to execute "SAVE: NO". Changes are not saved. To toggle between "SAVE: YES" and "SAVE: NO" press «↶».



### Cancel

For leaving menu topic or menu selection without saving press «C» (one step back in the menu).

**Note:** If no entry is made within 20 seconds, the balance reverts to last active application mode. Changes are not saved. If changes are made, the balance asks "SAVE:NO".

## 6.3 Description of Menu Topics

In this Section you will find information regarding the individual menu topics and the available selections.

### 6.3.1 Menu Mode

#### "SET MENU" – Menu Mode

Selecting the menu mode.

"BASIC"	The small "BASIC" menu for simple weighing is visible.
"ADVANCED"	The full "ADVANCED" menu for all weighing settings is visible.
"INT.FACE"	The menu topics for all interface parameter settings for peripheral devices e.g. printer are visible.
"OFF"	Menu Selection "OFF" is visible only.

### 6.3.2 Basic Menu

#### "DATE" – Date

Setting the current date according to date format.

**Note:** A reset of the balance will not change this setting.

#### "TIME" – Time

Setting the current time according to time format

"SET TIME"	Enter the current time.
" +1H"	Set the current time forwards by 1 hour. (to adjust summer or winter time).
" -1H"	Set the current time backwards by 1 hour. (to adjust summer or winter time)

**Note:** A reset of the balance will not change this setting.

#### "UNIT 1" – Weight Unit 1

Depending on requirements, the balance can operate with the following units (depend on the model)

- Only those weight units allowed by the appropriate national legislation are selectable.
- With approved balances, this menu topic has a fixed setting and cannot be changed.
- Conversion table for weight units see chapter Appendix.

#### Units:

<b>g</b> <sup>1)</sup>	Gram	<b>dwt</b>	Pennyweight
<b>kg</b> <sup>2)</sup>	Kilogram	<b>mom</b>	Momme
<b>mg</b> <sup>3)</sup>	Miligram	<b>msg</b>	Mesghal
<b>ct</b>	Carat	<b>tlh</b>	Tael Hong Kong
<b>lb</b>	Pound	<b>tls</b> <sup>4)</sup>	Tael Singapore
<b>oz</b>	Ounce (avdp)	<b>tlt</b>	Tael Taiwan
<b>ozt</b>	Ounce (troy)	<b>tola</b>	Tola
<b>GN</b>	Grain	<b>baht</b>	Baht

<sup>1)</sup> factory setting

<sup>2)</sup> not with 0.01 mg and 1 mg balances

<sup>3)</sup> with 0.1 mg and 1 mg balances

<sup>4)</sup> the Malaysian tael has the same value

**"UNIT 2" – Weight Unit 2**

If it is required to show the weighing results in weighing mode in an additional unit the desired second weight unit can be selected in this menu topic (depends on the model). Units see "UNIT 1". Select "NO", if you do not want to use "UNIT 2".

**Note:** Only those weight units allowed by the appropriate national legislation are selectable.

**"KEY BEEP" – Key Beep**

This menu topic allows you to select the volume of the key beep. The according key beep is emitted during the setting.

"MED"	<b>Medium</b> level ( <b>Factory setting</b> )
"HIGH"	<b>High</b> level
"OFF"	Beep switched off
"LOW"	<b>Low</b> level

**"RESET" – Reset Balance Settings**

This menu topic allows you to cal-up of the factory settings.

To toggle between "YES?" and "NO?" press «».



**Note:** A reset of the balance will not change the "DATE" and "TIME" settings.

**6.3.3 Advanced Menu****"ENVIRON." – Environment Settings**

This setting can be used to match your balance to the ambient conditions.

"STANDARD"	Setting for an average working environment subject to moderate variations in the ambient conditions. ( <b>Factory setting</b> )
"UNSTABLE"	Setting for an working environment where the conditions are continuously changing.
"STABLE"	Setting for an working environment which is practically free from drafts and vibrations.

**"CAL" – Adjustment (calibration)**

In this menu topic you can preselect the function of the «» key. Your balance can be adjusted with internal or external weights by pressing the «» key. If you have attached a printer to your balance, the data of the adjustment (calibration) are printed out.

"ADJ.OFF"	The adjustment is <b>switched off</b> . The «  » key has no function.
"ADJ.INT"	<b>Internal</b> adjustment: adjustment is performed at a keystroke with the built-in weight (depend on the model, see technical data).
"ADJ.EXT"	<b>External</b> adjustment: adjustment is performed at a keystroke with a selectable external weight. <b>Note:</b> This function is not available for approved balances.
"200.00 g"	<b>Defining the external adjustment weight:</b> define the weight of the external adjustment weight (in grams). <b>Factory setting:</b> depends on the model.

**"FACT" – Fully Automatic Adjustment**

Fully automatic internal adjustment (calibration) **FACT** (Fully Automatic Calibration Technology) provides fully automatic balance adjustment based on temperature criteria and on preselected time. (depend on the model, see technical data)

"TIME"	Execute FACT (with selected time).
"12:00"	Specify the time for a fully automatic adjustment to take place every day. <b>Factory setting:</b> 12:00 (according to time format)
"OFF"	The selected time for FACT is <b>switched off</b> .

**"FACT PRT." – Protocol Trigger for Fact**

This setting specifies whether an adjustment report should be printed automatically.

**Note:** This menu topic does not affect the printing of adjustments with an internal or external adjustment weight.

"OFF"	<b>Protocol switched off:</b> if the balance adjusts automatically (FACT), a protocol is not printed out.
"ON"	Protocol switched on: a record is printed out after every automatic adjustment of the balance (FACT). <b>Note:</b> The protocol is printed out without a line for signatures.

**"DATE" – Date**

Setting the current date according to date format.

**Note:** A reset of the balance will not change this setting.

**"DATE.FORM" – Date Format**

This menu topic allows you to preselect the date format.

The following date formats are available:

	<b>Display examples</b>	<b>Printing examples</b>
"DD.MM.Y"	01.01.2009	01.01.2009
"MM/DD/Y"	01/01/09	01/01/2009
"Y-MM-DD"	09-01-01	2009-01-01
"D.MMM.Y"	1.JAN.09	1.JAN.2009
"MMM D Y"	JAN 1 09	JAN 1 2009

**Factory setting:** "DD.MM.Y"

**"TIME" – Time**

Setting the current time according to time format

"SET TIME"	Enter the current time.
"+1H"	Set the current time forwards by 1 hour. (to adjust summer or winter time).
"-1H"	Set the current time backwards by 1 hour. (to adjust summer or winter time)

**Note:** A reset of the balance will not change this setting.



**"TIME.FORM" – Time Format**

This menu topic allows you to preselect the time format.

The following date formats are available:

	<b>Display examples</b>
"24:MM"	15:04
"12:MM"	3:04 PM
"24.MM"	15.04
"12.MM"	3.04 PM

**Factory setting:** "24:MM"

**"RECALL" – Recall**

This menu topic allows you to switch the "RECALL" function on or off. When it is switched on recall stores the last stable weight if the absolute display value was bigger than 10d.

"ON"	"RECALL" switched on
"OFF"	"RECALL" switched off

**Note:** The recall value is displayed with an asterisk and cannot be printed.

**"UNIT 1" – Weight Unit 1**

Depending on requirements, the balance can operate with the following units (depend on the model)

- Only those weight units allowed by the appropriate national legislation are selectable.
- With approved balances, this menu topic has a fixed setting and cannot be changed.
- Conversion table for weight units see chapter Appendix.

**Units:**

<b>g</b> <sup>1)</sup>	Gram	<b>dwt</b>	Pennyweight
<b>kg</b> <sup>2)</sup>	Kilogram	<b>mom</b>	Momme
<b>mg</b> <sup>3)</sup>	Miligram	<b>msg</b>	Mesghal
<b>ct</b>	Carat	<b>tlh</b>	Tael Hong Kong
<b>lb</b>	Pound	<b>tls</b> <sup>4)</sup>	Tael Singapore
<b>oz</b>	Ounce (avdp)	<b>tlt</b>	Tael Taiwan
<b>ozt</b>	Ounce (troy)	<b>tola</b>	Tola
<b>GN</b>	Grain	<b>baht</b>	Baht

<sup>1)</sup> factory setting

<sup>2)</sup> not with 0.01 mg and 1 mg balances

<sup>3)</sup> with 0.1 mg and 1 mg balances

<sup>4)</sup> the Malaysian tael has the same value

**"UNIT 2" – Weight Unit 2**

If it is required to show the weighing results in weighing mode in an additional unit the desired second weight unit can be selected in this menu topic (depends on the model). Units see "UNIT 1". Select "NO", if you do not want to use "UNIT 2".

**Note:** Only those weight units allowed by the appropriate national legislation are selectable.

**"KEY BEEP" – Key Beep**

This menu topic allows you to select the volume of the key beep. The according key beep is emitted during the setting.

"MED"	<b>Medium</b> level ( <b>Factory setting</b> )
"HIGH"	<b>High</b> level
"OFF"	Beep switched off
"LOW"	<b>Low</b> level

**"STAB.BEEP" – Stability Beep**

If the unstable symbol disappears, the stability beep becomes active. This menu topic allows you to preselect the volume of the stability beep.

"MED"	<b>Medium</b> level ( <b>Factory setting</b> )
"HIGH"	<b>High</b> level
"OFF"	Beep switched off
"LOW"	<b>Low</b> level

**"STARTUP" – Startup Mode**

You can set your balance such that it either immediately starts from the standby mode when you load a weight or it must be switched on with the «**ON/OFF**» key after which it then performs a display test.

**Note:** This topic is not visible with approved balances.

"FULL"	<b>Start with display test:</b> You must switch on the balance with the « <b>ON/OFF</b> » key. After it has been switched on, it performs a display test for approx. 2 sec. in which all display elements lights up, it shows "WELCOME" ,software version, maximum load and readability. The balance is ready for weighing. This is the <b>Factory setting</b> .
"QUICK"	<b>"Quickstart":</b> The balance can be started directly from the standby mode and is immediately ready for weighing. You can load the weight in the standby mode and the balance immediately shows the current weighing result. <b>Note:</b> Standby mode is available by line powered balances only.

**"SHUTOFF" – Automatic Shutoff**

If the automatic shutoff function is activated, the balance automatically switches itself off after a preselected time of inactivity (i.e. with no key being pressed or changes of weight occurring etc.) and is switched to the standby mode.

"A.OFF 10" min	Automatic shutoff after <b>10 minutes</b> of inactivity. ( <b>Factory setting</b> )
"A.OFF –"	Automatic shutoff <b>not</b> activated.
"A.OFF 2" min	Automatic shutoff after <b>2 minutes</b> of inactivity.
"A.OFF 5" min	Automatic shutoff after <b>5 minutes</b> of inactivity.

**"BCKLIGHT" – Backlight**

Under this menu topic, the display backlight can be switched off automatically. If the automatic switch-off is activated, the backlight will turn off automatically after the selected period of inactivity has elapsed. The backlight is reactivated when a key is pushed or the weight is changed.

"B.L. ON"	Backlight is always <b>on</b> . ( <b>Factory setting</b> )
-----------	--

"B.L. 30" s	Automatic switch-off after <b>30 seconds</b> inactivity.
"B.L. 1" min	Automatic switch-off after <b>1 minute</b> inactivity.
"B.L. 2" min	Automatic switch-off after <b>2 minutes</b> inactivity.
"B.L. 5" min	Automatic switch-off after <b>5 minutes</b> inactivity.

### "DISPLAY" – Display Settings

This menu topic allows you to adjust brightness and contrast of the display.

"BRIGHTN"	To set the brightness in 1% steps.
"50%"	Factory setting: 50%
"CONTRAST"	To set the contrast in 1% steps.
"75%"	Factory setting: 75%

### "AUTOZERO" – Automatic Zero Setting

This menu topic allows you to switch the automatic zero setting on or off.

"ON"	"AUTOZERO" <b>switched on</b> (factory setting). The automatic zero setting continuously corrects possible variations in the zero point that might be caused through small amounts of contamination on the weighing pan.
"OFF"	"AUTOZERO" <b>switched off</b> . The zero point is not automatically corrected. This setting is advantageous for special applications (e.g. evaporation measurements).

**Note:** With approved balances, this setting is not available.

### "SERV.ICON" – Service Reminder

This menu topic allows you to switch the service icon "🔧" on or off.

"ON"	Service icon "🔧" <b>switched on</b> (factory setting). You will be informed after one Year or 8000 operating hours to call service for recalibration. This will be indicated by the flashing service icon.
"OFF"	Service icon "🔧" <b>switched off</b> .

### "ZERO RNG" – Zero Range

This menu topic allows you to set a zero limit for the «→0/T←» key. Up and including this limit the «→0/T←» key will execute a zero. Above this limit the «→0/T←» key will execute a tare.

"WEIGHT"	To set the upper limit of the zeroing range as weight in the definition unit of the balance.
"4200g"	
"PERCENT"	To set the upper limit of the zeroing range as a percent of the total range of the balance.
"100%"	

### "LANGUAGE" – Language

**Factory setting:** Generally, the language of the destination country (if available) or English is set.

The following languages are available:

"ENGLISH"	English	"ITALIANO"	Italian
"DEUTSCH"	German	"POLSKI"	Polish

"FRANCAIS"	French	"CESKY"	Czech
"ESPANOL"	Spanish	"MAGYAR"	Hungarian

**"ASSIGN:F1" – Assign Application Key F1**

At this menu topic you can assign an application to the "F1" key. The following applications are available (depends on the model):

"F1:COUNT"	Piece counting ( <b>Factory setting</b> )
"F1:PERC.W"	Percent weighing
"F1:CHECKW."	Checkweighing
"F1:STAT."	Statistics
"F1:FORM."	Formulation / Net-Total
"F1:TOTAL."	Totaling
"F1:DYN."	Dynamic weighing
"F1:F.MUL"	Multiplication factor

**"ASSIGN:F2" – Assign Application Key F2**

At this menu topic you can assign an application to the "F2" key. The following applications are available (depends on the model):

"F2:PERC.W"	Percent weighing ( <b>Factory setting</b> )
"F2:CHECKW."	Checkweighing
"F2:STAT."	Statistics
"F2:FORM."	Formulation / Net-Total
"F2:TOTAL."	Totaling
"F2:DYN."	Dynamic weighing
"F2:F.MUL"	Multiplication factor
"F2:COUNT"	Piece counting

**"ASSIGN:F3" – Assign Application Key F3**

At this menu topic you can assign an application to the "F3" key. The following applications are available (depends on the model):

"F3:CHECKW."	Checkweighing ( <b>Factory setting</b> )
"F3:STAT."	Statistics
"F3:FORM."	Formulation / Net-Total
"F3:TOTAL."	Totaling
"F3:DYN."	Dynamic weighing
"F3:F.MUL"	Multiplication factor
"F3:R.TEST"	Routine test
"F3:COUNT"	Piece counting
"F3:PERC.W"	Percent weighing

### "DIAGNOSE" – Diagnostics Application

At this menu topic you can start a diagnostic application. For more information see chapter application "Diagnostics".

The following diagnostics are available:

"DISPLAY"	Display test
"KEYPAD T"	Key test
"CAL.MOT. T"	Motor test (models with internal weights only)
"BAL.HIST"	Balance history
"CAL.HIST"	Calibration history
"BAL.INFO"	Balance information
"PROVIDER"	Service provider information
"REPEAT.T"	Repeatability test (models with internal weights only)

### "RESET" – Reset Balance Settings

This menu topic allows you to cal-up of the factory settings.







To toggle between "YES?" and "NO?" press «».



**Note:** A reset of the balance will not change the "DATE" and "TIME" settings.

## 6.3.4 Interface Menu

### "RS232" – RS232C Interface

At this menu topic you can select the peripheral device connected to the RS232C interface and specify how the data is transmitted.

"PRINTER"	Connection to a <b>printer</b> .
"PRT.STAB"	If the «  » key is pressed, the next stable weight value will be printed. ( <b>Factory setting</b> )
"PRT.AUTO"	Every stable weight value will be printed, without pressing the «  » key.
"PRT.ALL"	If the «  » key is pressed, the weight value will be printed regardless of stability.
"PC-DIR."	Connection to a <b>PC</b> : the balance can send data (as a Keyboard) to the PC used for PC applications e.g. Excel.
"PRT.STAB"	If the «  » key is pressed, the next stable weight value will be sent followed by an enter. ( <b>Factory setting</b> )
"PRT.AUTO"	Every stable weight value will be sent followed by an enter, without pressing the «  » key.
"PRT.ALL"	If the «  » key is pressed, the weight value will be sent followed by an enter regardless of stability.
"HOST"	Connection to a <b>PC</b> , Barcode Reader etc.: the balance can send data to the PC and receive commands or data from the PC).
"SEND.OFF"	Send mode switched off. ( <b>Factory setting</b> )
"SEND.STB"	If the «  » key is pressed, the next stable weight value will be sent.

"SEND.CONT"	All weight value updates will be sent regardless of stability, without pressing the «  » key.
"SEND.AUTO"	Every stable weight value will be sent, without pressing the «  » key.
"SEND.ALL"	If the «  » key is pressed, the weight value will be sent regardless of stability.
"2.DISPLAY"	Connection of an <b>optional auxiliary display</b> unit (transmission parameters cannot be selected).

### "BAUDRATE" – Bauderate RS232C

This menu topic allows you to match the data transmission to different serial RS232C receivers. The baud rate (data transfer rate) determines the speed of transmission via the serial interface. For problem-free data transmission the sending and receiving devices must be set at the same value.

The following settings are available:

600 bd, 1200 bd, 2400 bd, 4800 bd, 9600 bd, 19200 and 38400 bd. (default: **9600 bd**)

**Note:**

- Not visible for 2nd display.
- Each device has separate settings.

### "BIT/PAR." – Bit/Parity RS232C

At this menu topic you can set the character format for the attached RS232C serial peripheral device.

"8/NO"	8 data bits/no parity ( <b>Factory setting</b> )
"7/NO"	7 data bits/no parity
"7/EVEN"	7 data bits/even parity
"7/ODD"	7 data bits/odd parity

**Note:**

- Not visible for 2nd display.
- Each device has separate settings.

### "HD.SHAKE" – Handshake RS232C

This menu topic allows you to match the data transmission to different RS232C serial receivers.

"XON/XOFF"	Software handshake (XON/XOFF) ( <b>Factory setting</b> )
"RTS/CTS"	Hardware handshake (RTS/CTS)
"OFF"	No handshake

**Note:**

- Not visible for 2nd display.
- Each device has separate settings.

### "RS E.O.L." – End of Line RS232C

At this menu topic you can set the "End of Line" character of the transmitted data to different RS232C serial receivers.

"(CR)(LF)"	<CR><LF> Carriage Return followed by Line feed (ASCII-Codes 013+010) ( <b>Factory setting</b> )
------------	---

"(CR)"	<CR> Carriage Return (ASCII-Code 013)
"(LF)"	<LF> Line feed (ASCII-Code 010)

**Note:**

- Not visible for 2nd display.
- Each device has separate settings.

**"RS CHAR" – Char Set RS232C**

At this menu topic you can set the "Character Set" of the transmitted data to different RS232C serial receivers.

"IBM/DOS"	Char Set <b>IBM/DOS (Factory setting)</b>
"ANSI/WIN"	Char Set <b>ANSI/WINDOWS</b>





**Note:**

- Not visible for 2nd display.
- Each device has separate settings.

**"USB" – USB Interface**

At this menu topic you can select the mode of the "USB Device" interface and specify how the data is transmitted.

**Note:** this port is not usable for printers or displays.

"USB"	Select the mode of the "USB Device" interface
"SEND.OFF"	Send mode switched off ( <b>Factory setting</b> )
"SEND.STB"	If the «  » key is pressed, the next stable weight value will be sent.
"SEND.CONT"	All weight value updates will be sent regardless of stability, without pressing the «  » key.
"SEND.AUTO"	Every stable weight value will be sent, without pressing the «  » key.
"SEND.ALL "	If the «  » key is pressed, the weight value will be sent regardless of stability.

**"USB E.O.L." – End of Line USB**

At this menu topic you can set the "End of Line" character of the transmitted data to USB device.

"(CR)(LF)"	<CR><LF> Carriage Return followed by Line feed (ASCII-Codes 013+010) (Factory setting)
"(CR)"	<CR> Carriage Return (ASCII-Code 013)
"(LF)"	<LF> Line feed (ASCII-Code 010)

**"USB CHAR" – Char Set USB**

At this menu topic you can set the "Character Set" of the transmitted data to USB device.

"ANSI/WIN"	Char Set <b>ANSI/WINDOWS (Factory setting)</b>
"IBM/DOS"	Char Set <b>IBM/DOS</b>

### **"INTERVAL" – Print Key Simulation**

At this menu topic you can activate a simulation of the «» key. "INTERVAL" simulates a print key press every x seconds.

Range:	0 to 65535 seconds
0 sec:	disables the print key simulation

**Factory setting:** 0 sec



## 7 Application "Piece Counting"

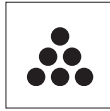

The "**Piece Counting**" application allows you to determine the number of pieces put on the weighing pan.

**Requirement:** The function "COUNTING" must be assigned to an «Fx» key (see advanced menu topic "ASSIGN:Fx", factory setting: F1).



Activate function "COUNTING" by pressing and hold the appropriate assigned «Fx» key (factory setting: F1).

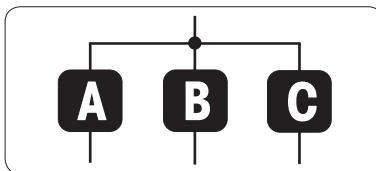

**Piece counting needs first a reference weight, there are 3 possibilities:**

- A** Setting the reference **by number**.
- B** Setting the reference **for 1 piece in weighing mode**.
- C** Setting the reference **for 1 piece in manual mode**.

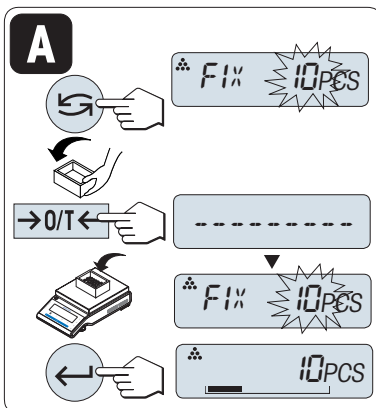

Setting possibility

### **A** Setting the reference by number

- a) Select a number of reference pieces by scrolling with «». Possible numbers are 5, 10, 20 and 50.
- b) Press «0/T» to tare. If using: place empty container on the weighing pan first or tare again.
- c) Add the selected number of reference pieces to container.
- d) Press «» to confirm.

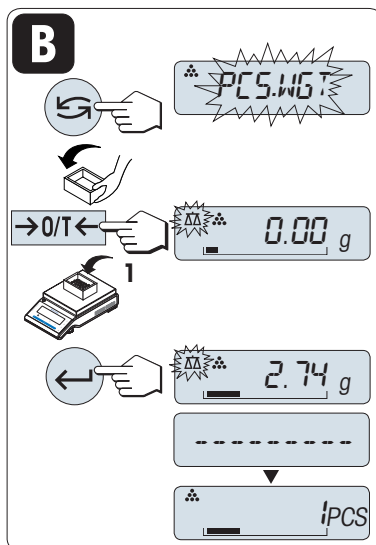

Setting possibility

### **B** Setting the reference for one piece in weighing mode

- a) Select "PCS.WGT" by scrolling with «».
- b) Press «0/T» to tare. If using: place empty container on the weighing pan first or tare again.
- c) Add one reference piece to container. The weight of one piece is displayed.
- d) Press «» to confirm.

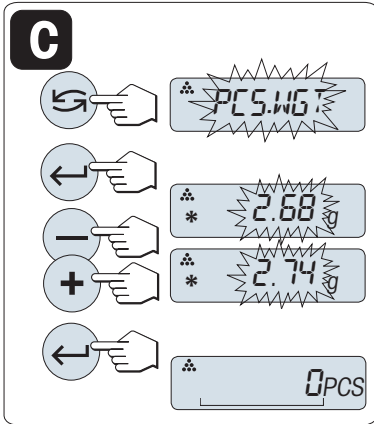

Setting possibility

**C** Setting the reference for one piece in manual mode

- a) Select "PCS.WGT" by scrolling with «↔».
- b) Press «←» to confirm.
- c) Enter the final reference one piece weight by scrolling up («+» key) or down («-» key).
- d) Press «←» to confirm.

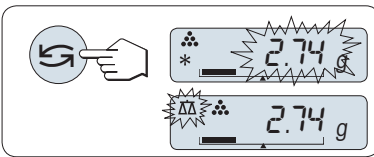

**Switching between manual mode and weighing mode**

Press «↔» to switch between manual and weighing mode.

**Note:** By switching from weighing mode to manual mode the weight value will be transferred and can be changed manually.

**Note:** If you do not press a key for 20 seconds, the balance returns to the previous active application. Press «C» to cancel.

**On completion of the setting procedure, your balance is ready for piece counting.**

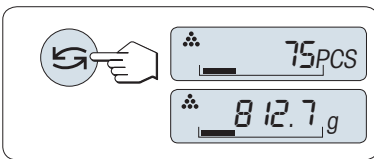

**Switching between piece count and weight display.**

You can use the «↔» key at any time to switch the display between piece display, weighing unit "UNIT 1", "RECALL" value (if activated) and weighing unit "UNIT 2" (if different from "UNIT 1").

**Note:**

- The "RECALL" value is displayed with an asterisk (\*) and icon "M" and can not be printed.
- Take into account minimum values: min. reference weight = 10d (10 digits), min. piece weight = 1d (1 digit)!
- The current reference weight remains stored until the reference setting is changed.

## 8 Application "Percent Weighing"

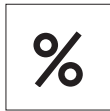

The "**Percent Weighing**" application allows you to check a sample weight as percentage to a reference target weight.

**Requirement:** The function "PERCENT" must be assigned to an «Fx» key (see advanced menu topic "ASSIGN:Fx", factory setting: F2).



Activate function percent weighing "PERCENT" by pressing and hold the appropriate assigned «Fx» key (factory setting: F2).

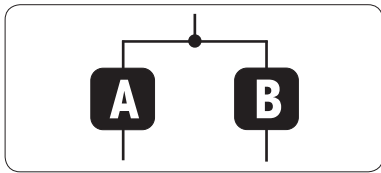

**Percent weighing needs first a reference weight that should correspond to 100%, there are 2 possibilities:**

- A** Setting the reference **in manual mode (enter 100%)**.
- B** Setting the reference **in weighing mode (weigh 100%)**.

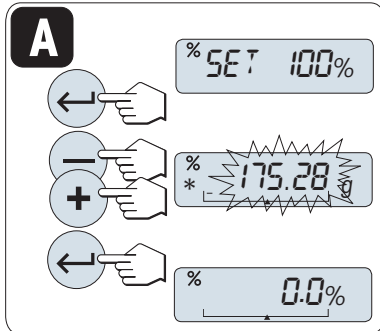

Setting possibility

**A** **Setting the reference by manual mode**(enter 100%)

- a) Press «←|» to activate manual mode.
- b) Select the reference target weight (100%) by scrolling up («+» key) or down («-» key). Progressing speed by press and hold.
- c) Press «←|» to confirm.

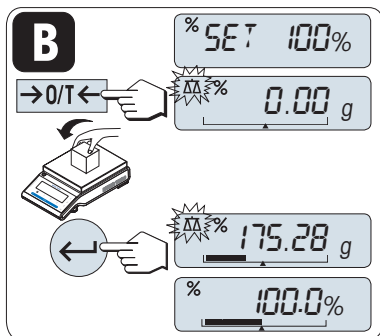

Setting possibility

**B** **Setting the reference by weighing mode**(weigh 100%)

- a) Press «→O/T←» to tare the balance and to activate the weighing mode. If using: place empty container on the weighing pan first or tare again.
- b) Load the reference weight (100%).
- c) Press «←|» to confirm.

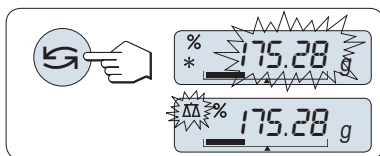

**Switching between manual mode and weighing mode**

Press «↻» to switch between manual and weighing mode.

**Note:** By switching from weighing mode to manual mode the weight value will be transferred and can be changed manually.

**Note:**

If you do not press a key for 20 seconds, the balance returns to the previous active application.

**On completion of the weighing-in procedure, your balance is ready for percent weighing.**

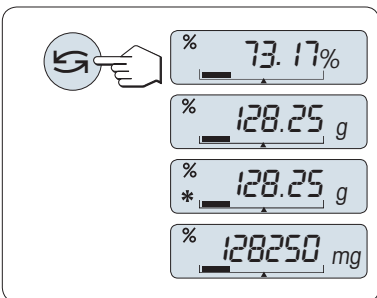

### Switching between percent and weight display

You can use the «» key at any time to switch the display between percent display, weighing unit "UNIT 1", "RECALL" value (if activated) and weighing unit "UNIT 2" (if different from UNIT 1).

#### Note:

- The recall value is displayed with an asterisk (\*) and can not be printed.
- The current set weight remains stored until it is redetermined.

## 9 Application "Check Weighing"



The "**Check weighing**" application allows you to check the deviation of a sample weight within a tolerance limit to a reference target weight.

**Requirement:** The function "CHECK" must be assigned to an «Fx» key (see advanced menu topic "ASSIGN:Fx", factory setting: F3).

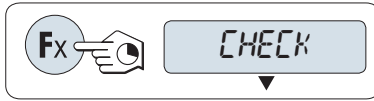

Activate function "CHECK" by pressing and hold the appropriate assigned «Fx» key (factory setting: F3).

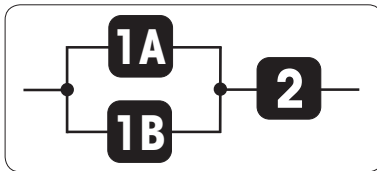

**Step 1: Check weighing needs first a reference weight that should correspond to the nominal weight, there are 2 possibilities:**

**1A** Setting the reference **in manual mode**. (enter nominal weight)

**1B** Setting the reference **in weighing mode**. (weigh nominal weight)

**Step 2: Check weighing needs the upper and lower limits:**

**2** Setting the **upper and lower limits**.

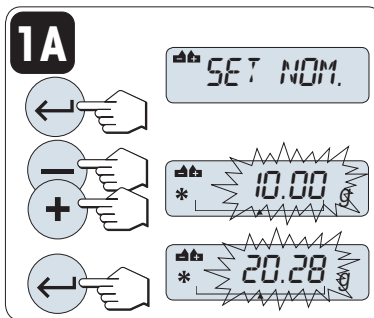

Setting possibility:

**1A** **Setting the reference by manual mode** (enter nominal weight)

a) Press «←» to activate manual mode.

b) Select the reference target weight by scrolling up («+» key) or down («-» key). Progressing speed by press and hold.

c) Press «←» to confirm the nominal weight.

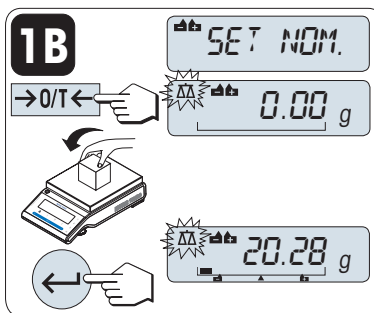

Setting possibility:

**1B** **Setting the reference by weighing mode** (weigh nominal weight)

a) Press «→0/T←» to tare the balance and to activate the weighing mode. If using: place empty container on the weighing pan first or tare again.

b) Load the nominal weight.

c) Press «←» to confirm the nominal weight.

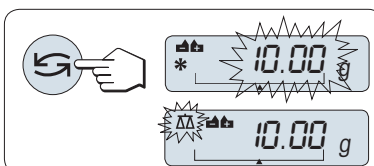

**Switching between manual mode and weighing mode**

Press «↻» to switch between manual mode and weighing mode.

**Note:** By switching from weighing mode to manual mode the weight value will be transferred and can be changed manually.

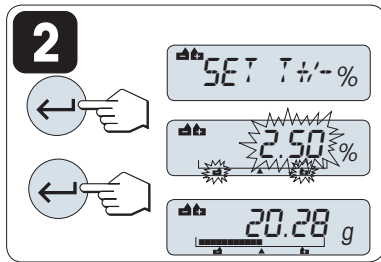

Step 2:

**2** Setting the upper and lower limits (in percentage):

- a) Press «←» to start setting.
- b) Press «←» to confirm the default limit of +/- 2.5 % or enter the limit value by scrolling up («+» key) or down («-» key). Press «←» to confirm the limits.

**Note:**

- If you do not press a key for 20 seconds, the balance returns to the previous active application. Press «C» to cancel.
- The nominal weight must be at least 10 digit.

**On completion of the setting procedure, your balance is ready for checkweighing.**

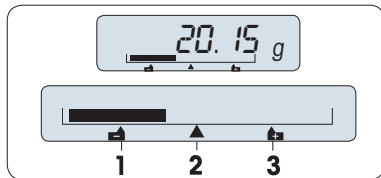

**Weighing-in-Aid**

The Weighing-in-Aid helps you quickly determine the position of the sample weight regarding the tolerance.

- 1** Lower limit
- 2** Target weight
- 3** Upper limit

## 10 Application "Statistics"



The "Statistics" application allows you to generate statistics of weighing values. 1 to 999 values are possible. **Requirement:** The function "STAT" must be assigned to an «Fx» key (see advanced menu topic "ASSIGN:Fx"). Connect a printer or a PC if present.

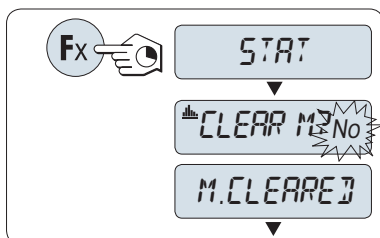

- Activate function "STAT" by pressing and hold the appropriate assigned «Fx» key.
- To continue the last statistics press «←». For a new statistical evaluation press «→» to select "Yes" and press «←» to clear the memory.

**Note:** If the memory is already cleared (sample counter is 0) the memory clear question will be not displayed.

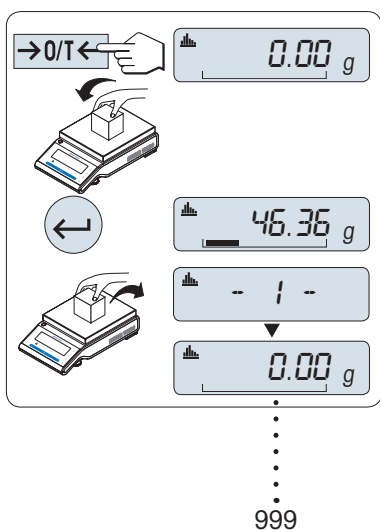

### Weighing the first sample weight:

- Press «→O/T←» to zero/tare the balance if needed.
- Load the first sample weight.
- Press «←». The display shows the sample count "- 1 -" and the current weight is stored as sample and the weight is printed out. **Note:** When the sample counter is displayed you may press «C» to undo this sample.
- Unload the first sample weight.

### Weighing further sample weights:

The same procedure as for the first sample weight.

- 1...999 samples are possible.
- The next value will be accepted if the sample weight is in the range 70% –130% of the current average value and the dynamic weight has changed at least 100 digits. "OUT OF RANGE" will be displayed if the sample is not accepted.







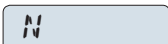
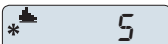

### Results:

Press «», the results are displayed and printed.

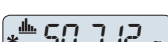
### Displayed results:

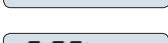
- Press «←» to show the next statistical value.
- Press «C» to cancel displaying results and to continue weighing next sample.

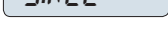
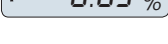
		0.5 seconds
number of samples		
average		
standard deviation		
relative standard deviation		
lowest value (minimum)		

highest value (maximum) MAX \* 53.45 g ←

different between the minimum  
and the maximum DIFF \* 53.45 g ←

sum of all values SUM \* 53.45 g ←

**Printout:**

```

|           -- Statistics --           |
| 21.Jan. 2009           12:56 |
| Balance Type           MS4002S |
| SNR                    1234567890 |
| ----- |
| 1                      46.36 g |
| 2                      55.81 g |
| 3                      47.49 g |
| 4                      53.28 g |
| 5                      49.71 g |
| n                       5 |
| x                      50.712 g |
| s dev                   3.364 g |
| s rel                   6.63 % |
| Min.                   46.36 g |
| Max.                   55.81 g |
| Diff                    9.45 g |
| Sum                    235.56 g |
| ----- |

```



# 11 Application "Formulation" (Net Total Formulation)



The "Formulation" (Net Total) application allows you to

- weighing in (add and store) up to 999 individual component weights and displays the total. If a printer is connected, the component weights are printed individually and as a total.
- tare and store up to 999 container weights and displays the total. If a printer is connected, the tare weights are printed out individually and as a total.

**Requirement:** The function "FORMULA" must be assigned to an «Fx» key (see advanced menu topic "ASSIGN:Fx"). Connect a printer or a PC if present.

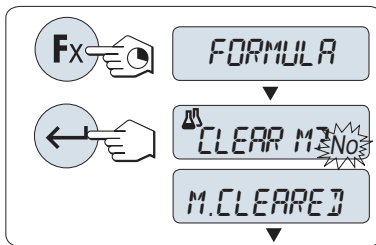

- Activate function formulation "FORMULA" by pressing and hold the appropriate assigned «Fx» key.
- Press «←» to continue formulation weighing. For a new formulation press «↻» to select "Yes" and press «←» to clear the memory. **Note:** If the memory is already cleared (sample counter is 0) the memory clear question will be not displayed.

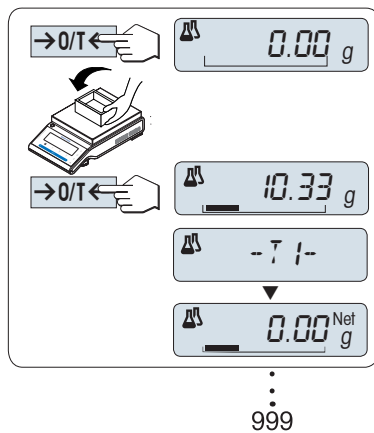

**Tare container** (if used):

- Press «→0/T←» to zero the balance if needed.
- Place the empty container on the weighing pan.
- Press «→0/T←». The container is tared and the tare count "- T1 -" is displayed and the tare weight is printed.

**Note:** If you pre-tare via MT-SICS (e.g. bar code reader) "- PT1 -" is displayed.

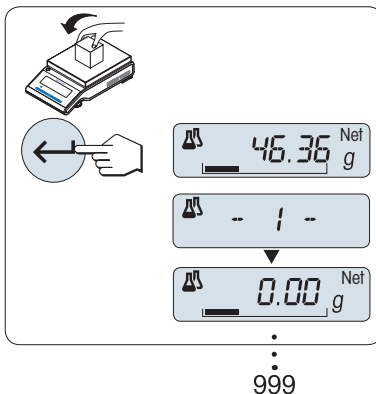

**Weighing the first component weight:**

- Load the first component weight.
- Press «←». The display briefly shows the component count "- 1 -", the current weight is stored as sample and the component weight is printed. The display is set back to zero.

**Weighing further component weights:**

The same procedure as for the first component weight with the same or new container).

- 1...999 sample values are possible.
- max 999 tare values are possible.

**Results:**

Press «», the results are displayed and printed.



**Displayed results:**

- a) Press «←|» to show the next statistical value.
- b) Press «C» to cancel displaying results and to continue weighing next component.

0.5 seconds

number of samples	N	▶	* <sup>Δ</sup>	8	←
sum of all tare values (T and PT)	T.TOTAL	▶	* <sup>Δ</sup>	452.76 g	←
sum of all component gross weight values	G.TOTAL	▶	* <sup>Δ</sup>	546.79 g	←
sum of all component net weight values	N.TOTAL	▶	* <sup>Δ</sup>	94.03 g	←

**Printout:**

```

|      -- Formulation --      |
| 21.Jan.2009      12:56 |
| Balance Type      MS4002S |
| SNR:              1234567890 |
| ----- |
| 1 T              10.33 g |
| 1 N              8.85 g |
| 2 N              9.23 g |
| 2 T              10.84 g |
| 3 N              7.43 g |
| . |
| . |
| n                999 |
| T Total          452.76 g |
| G Total          546.79 g |
| N Total          94.03 g |
| ----- |
    
```

## 12 Application "Totaling"



The "**TOTALING**" application allows you to weigh in different samples to add their weight values and to totalize them. 1 to 999 samples are possible.

**Requirement:** The function "TOTALING" must be assigned to an «Fx» key (see advanced menu topic "ASSIGN:Fx").

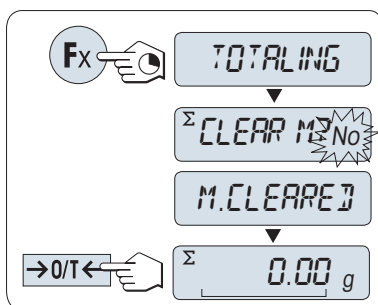

- Activate function "TOTALING" by pressing and hold the appropriate assigned «Fx» key.
- For a new totaling evaluation press «←» briefly to enter "Yes" and press «→» briefly to clear the memory.  
**Note:** If the memory is already cleared (sample counter is 0) the memory clear question will be not displayed.
- Press «→0/T←» to zero the balance.

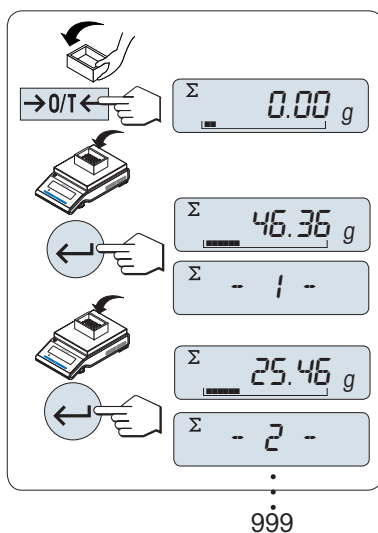

### Weighing in the sample weight:

- If using a container: place empty container on the weighing pan and press «→0/T←» to zero the balance.  
**Note:** The «→0/T←» key will always execute a zero, regardless of the menu setting.
- Load the first sample weight.
- Press «←». The display shows the sample count "- 1 -" and the current weight is stored. The balance is set to zero.  
**Note:** When the sample counter is displayed you may press «C» to undo this sample.
- Unload the second sample weight.
- Press «←». The display shows the sample count "- 2 -" and the current weight is stored. The balance is set to zero.

### Weighing in further sample weights:

- 1...999 samples are possible.

### Results:

Press «», the results are displayed and printed.

### Displayed results:

- Press «←↓» briefly to show the totaled value.
- Press «C» briefly to cancel.

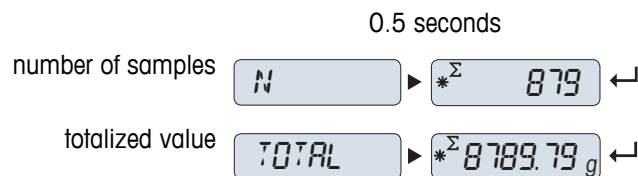

### Printout:

| ----- Totaling ----- |

```
| 21.Jan. 2009      12:56 |
| Balance Type      MS1602S |
| SNR:              1234567890 |
| ----- |
| 1                  46.36 g |
| 2                  55.81 g |
| 3                  47.49 g |
| 4                  53.28 g |
| 5                  49.71 g |
| 6                  53.93 g |
| . |
| . |
| . |
| n                  879 |
| Total              8789.79 g |
| ----- |
```

## 13 Application "Dynamic Weighing"



The "**Dynamic Weighing**" application allows you to determine the weights of unstable samples or to determine weights under unstable ambient conditions. The balance calculates the weight as the average of a number of weighing operations over a defined time.

**Requirement:** The function "DYNAMIC" must be assigned to an «Fx» key (see advanced menu topic "ASSIGN:Fx").

**Note:** "Switching Units" and "RECALL" Functions are not available in this Application.



Activate function "DYNAMIC" by pressing and hold the appropriate assigned «Fx» key.

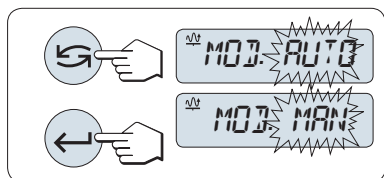

### 1 Setting "Auto Start" or "Manual Start":

- a) Press «←» to select the mode:
  - "**Auto Start**" "MOD AUTO" (default value). The weighing starts automatically on relative stability. However, the weighing sample must weigh at least 5 grams. For weighing samples below 5 g the weighing must be started manually.
  - "**Manual Start**" "MOD MAN"
- b) Press «←» to confirm the selection.

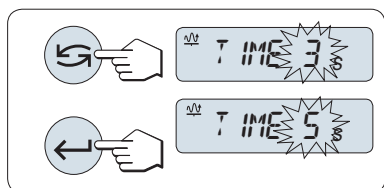

### 2 Setting the weighing time:

- a) Press «←» to select one of the available time intervals: 3 (default value), 5, 10, 20, 60 and 120 seconds.
- b) Press «←» to confirm the selected time interval.

**Note:** If you do not press a key for 20 seconds, the balance returns to the previous active application.

**Your balance is now ready for dynamic weighing:**

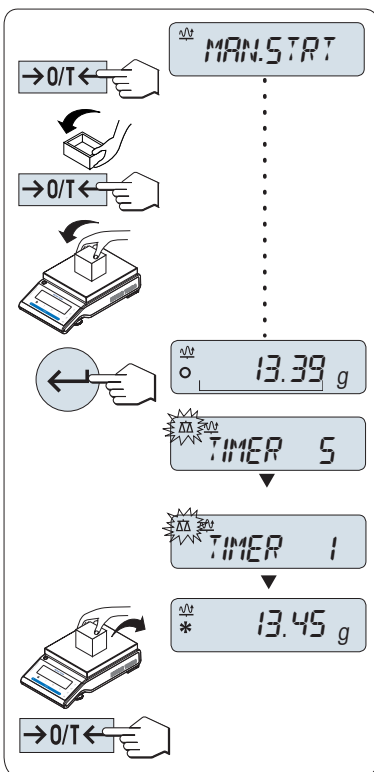

- a) Press «→0/T←» to zero if needed.
- b) If using a container: place empty container on weighing pan and press «→0/T←» to tare the balance.
- c) Load sample weight.
- d) – If you have selected function "**Manual Start**" "MAN.STRT", press «←» to start the weighing.  
– If you have selected function "**Auto Start**" "AUTO.STRT", the weighing starts automatically on relative stability. For weighing samples below 5 g the weighing must be started manually by pressing «←».
- e) Read off result. The result of the dynamic weighing is displayed with an asterisk (\* = calculated value).
- f) Unload sample weight.
- g) "**Manual Start**" only, press «→0/T←» to zero and confirm the weighing.

**Note:**

- The remaining weighing time (in seconds) is displayed continuously. You can cancel the countdown by pressing «C».
- The weight value remains in the display until the sample weight is removed from weighing pan and tare key «→0/T←» is pressed ("Manual Start" only).

## 14 Application "Multiplication Factor Weighing"



The "**Multiplication Factor Weighing**" application allows you to multiply the weight value (in grams) by a predefined factor (result = factor \* weight) and have it calculated to a predefined number of decimal places.

**Requirement:** The function "FACTOR M" must be assigned to an «Fx» key (see advanced menu topic "ASSIGN:Fx").



Activate function "FACTOR M" by pressing and hold the appropriate assigned «Fx» key.

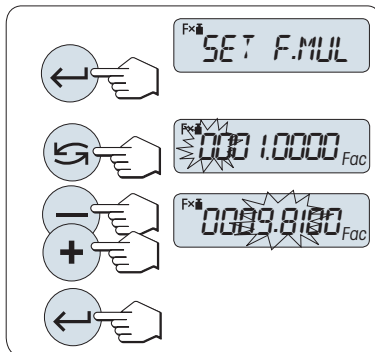

### 1 Setting the factor value:

Either the factor 1 appears as default value or the factor that was saved most recently.

- Press «**G**» to execute "SET F.MUL".
- Press «**G**» to select a digit. The selected digit is blinking.
- For changing digits, press «**+**» to scrolling up or «**-**» to scrolling down.
- Press «**G**» to confirm the selected factor (no automatic acceptance).

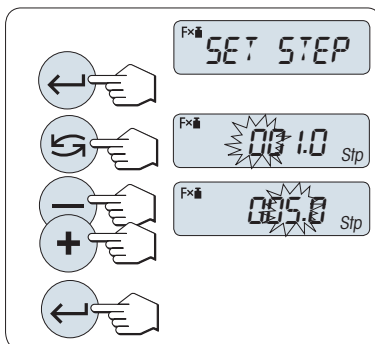

### 2 Setting the step value:

"SET STEP" appears in the display, and the program changes automatically to allow the display increments to be entered. The smallest possible display increment appears as default value, or the last value that was saved.

- Press «**G**» to execute "SET STEP".
- Press «**G**» to select a digit. The selected digit is blinking.
- For changing digits, press «**+**» to scrolling up or «**-**» to scrolling down.
- Press «**G**» to confirm the selected step (no automatic acceptance).

**Note:** The allowed range for the step depends on the multiplication factor and the resolution of the balance. If it is outside the allowed range the error message "STEP OUT OF RANGE" will be displayed.

**Note:** If you do not press a key for 20 seconds, the balance returns to the previous active application. Press «**C**» to cancel.

**On completion of the setting procedure, your balance is ready for multiplication factor weighing.**

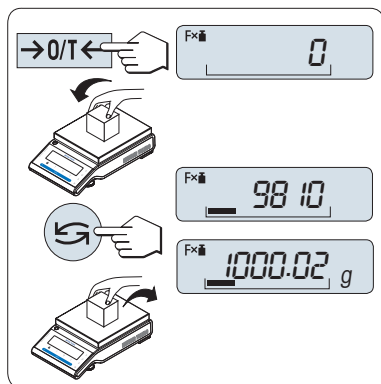

### Weighing procedure

- Press «→0/T←» to zero/tare.
- Load sample weight on weighing pan.
- Read the result. The appropriate calculation is then made using the weight of sample and the selected factor, the result being displayed with the selected display step.  
**Note:** No units are displayed.
- Unload sample weight.

### Toggeling between displaying the calculated value and the measured weight:

You can use the «G» key to toggle between the calculated Value, weight value "UNIT 1", "RECALL" value (if selected) and weight value "UNIT 2" (if different from "UNIT 1").



## 15 Application "Routine Test"



The "**Routine Test**" application allows you to determine the sensitivity of the balance. More about periodic sensitivity tests (routine tests) see: **GWP**<sup>®</sup> (Good Weighing Practice) on [www.mt.com/gwp](http://www.mt.com/gwp).

GWP gives clear recommendation for routine testing:

- how should I test my balance?
- how often?
- where can I reduce efforts?

More about test weights see [www.mt.com/weights](http://www.mt.com/weights).

### Requirement:

- The function "R.TEST" must be assigned to «F3» key (see advanced menu topic "ASSIGN:F3").
- It is recommended to connect a printer or a PC to the balance for showing the results.

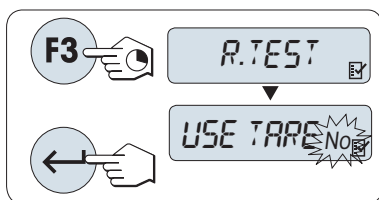

- Activate function "R.TEST" by pressing and hold the assigned «F3» key.
- Select "No" (no tare weight used). If a tare weight is used during the test select "Yes" (use a tare weight). To toggle between "Yes" and "No" use «↔».
- Press «←» to confirm the selection.

### Note:

- It is recommended to test the sensitivity without tare load. (factory setting "No").
- If using tare: Make shure that tare weight plus test weight is not exceeding max. load.

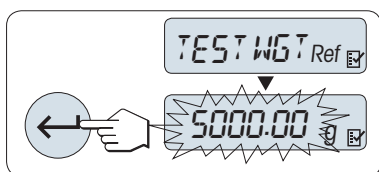

### Setting the reference test weight value

The default value of the testweight: Next smaller OIML weight than the maximum load of your balance according to the GWP<sup>®</sup> recommendation.

- For changing the value, press «+» to scroll up or «-» to scroll down. Progressing speed by press and hold.
- Press «←» to confirm the value.

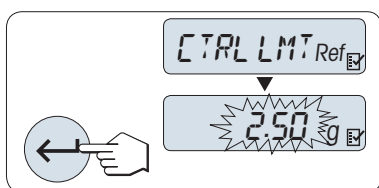

### Setting the Control Limit

The default value of the control limit:

Test weight x weighing process tolerance / 2

Example: 5000 g x 0.1% / 2 = 2.50 g.

- For changing the value, press «+» to scroll up or «-» to scroll down. Progressing speed by press and hold.
- Press «←» to confirm the value.

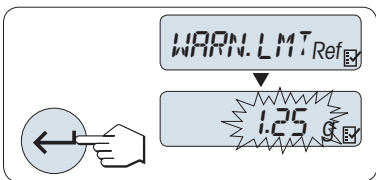

### Setting the Warning Limit

The default value of the warning limit:  
 Warning limit = control limit / safety factor  
 Example: 2.5 g / 2 = 1.25 g.

- a) For changing the value, press «+» to scroll up or «-» to scroll down. Progressing speed by press and hold.
- b) Press «←» to confirm the value.

**Note:** The default values of control limit and the warning limit are evaluated according the GWP recommendation. These are based under the assumption that the weighing process tolerance is 0.1% and the safety factor is 2.

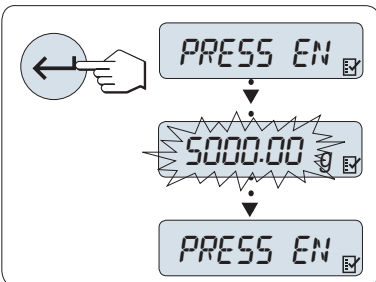

### On completion of the setting procedure, your balance is ready for the routine test procedure.

**Note:** The test weight must be acclimatized to the ambient temperature of the balance.

- a) Press «←» to start the test.
- b) Follow the instructions on the display. If the test weight value is flashing: Load the test weight (displayed value).

The printout starts after the weighing pan is unloaded.

### Exit the current test procedure:

Press and hold « $\Delta\Delta$ », «F1», «F2» for executing a new application or «F3» to restart "Routine Test".

### Printout:

```

|      -- Routine Test --      |
| 21.Jan. 2009          12:56 |
|                          |
| METTLER TOLEDO          |
|                          |
| Balance Type      MS6002S/01 |
| SNR:              1234567890 |
|                          |
| Sensitivity:      |
| Test weight      5000.00 g |
| Value            5000.11 g |
| Warning L.       1.25 g |
| Control L.       2.50 g |
| Warning L.       OK |
| Control L.       OK |
|                          |
| Signature          |
| .....          |
| -----          |
    
```

**What if Warning Limit or Control Limit are "FAILED"?**

The "SOP for Periodic Sensitivity Tests (Routine Tests)" is providing information about measures when routine tests failed. Find a download version of these SOPs on [www.mt.com/gwp](http://www.mt.com/gwp), link "**GWP® The Program / Routine Operation**".

**Content of SOP:**

- Preparation
- Test procedure
- Evaluation
- Deviation
  - If Warning Limit "FAILED"
  - If Control Limit "FAILED"

## 16 Application "Diagnostics"



The "**Diagnostics**" application allows you to carry out predefined diagnostics tests and to view or print predefined sets of balance information. This diagnostics tool helps you finding errors faster and more efficient.

**Requirement:** A printer or a PC is connected to the balance for showing the results.

- a) Activate "ADVANCED" menu. (see section menu operation)
- b) Activate function "DIAGNOSE" by pressing «←|».
- c) Use «←|» to select appropriate tests.

### 16.1 Repeatability Test

The repeatability test allows you to repeat tests with internal weight for a given number of times.

**Note:** On models with internal weights only.

- a) Press «←|» to activate repeatability test "REPEAT.T". "R.TST. 10" appears on the Display.
- b) Enter the number of times (blinking) the test must be repeated by pressing «+» or «-». Possible values are 5, 10 (default), 20, 50, 100 times.
- c) Press «←|» to start the test. The message "RUNNING REPEAT TEST" is displayed till the tests are completed.
- d) Press «C» to cancel the test procedure. The balance will return to the topic "DIAGNOSE".

#### Sample Printout:

```
|  -- Repeatability Test  --  |
| 21.Jan. 2009           11:34 |
|                          |
| METTLER TOLEDO         |
|                          |
| Balance Type           MS6002S/01 |
| SNR:                   1234567890 |
| SW:                     V1.00 |
| Temperature            21.3 °C |
| No. of tests           10 |
| ----- |
| 1.Value                2813.00 g |
| 1. Time                00:00:00 |
| 1. Temp.               21.3 °C |
| 2. Value                2813.01 g |
| 2. Time                00:00:04 |
| 2. Temp.               21.3 °C |
| .                      |
| .                      |
| .                      |
| ----- |
```

```

| Max.           2813.01 g |
| Min.           2813.00 g |
| x             2813.005 g |
| s Dev.         0.004 g   |
| Max Temp.      21.3 °C  |
| Min Temp.      21.3 °C  |
| Mean Temp.     21.3 °C  |
| Total Time     00:00:44 |
| -----      |

```

**Examples:**

Repeatability test is a tool to do functional check with the balance. It may be performed:

- **To check function of balance**
  - during installation to store print out with installation documents.
  - after preventative maintenance to store print out with installation maintenance report.
  - when remarkable decrease of weighing performance occurs to email/fax print out to service support provider for diagnose purposes.
- **To develop the optimal environment settings** (see menu topic "ENVIRON.").  
Perform repeatability test each with "STABLE", "STANDARD" and "UNSTABLE" setting. The setting with the fastest total time suits best for the existing environmental conditions.

## 16.2 Display Test

The display test allows you to test the display of the balance.

- a) Press «←|» to start "DISPLAY".  
All possible segments and icons on the display will illuminate.
- b) Press «|→» to print the test information.
- c) Press «C» to cancel the test procedure. The balance will return to the topic "DIAGNOSE".

**Sample Printout:**

```

|      -- Display Test --      |
| 21.Jan. 2009           11:34 |
|                          |
| METTLER TOLEDO         |
|                          |
| Balance Type           MS204S |
| SNR:                   1234567890 |
| SW:                     V1.00 |
| Display Test           DONE |
| -----      |





```

## 16.3 Key Test

The key test allows you to test the keys of the balance.

- a) Press «←|» to start "KEYPAD T".
- b) The message "KEY TEST - PRESS KEY TO BE TESTED" is displayed scrolling during the duration of the key test. Press every Key briefly. Each press of a key beeps and echoes with "OK" on the display.
- c) Second press «C» key to print the test information. The test procedure will be cancelled and the balance will return to the topic "DIAGNOSE". If a key has not been tested before printing, then the test results will be indicated with a "----" line.

**Sample Information Displayed:**

Key	Display
«  »	1/10 D OK
«  »	MENU OK
«  »	CAL OK
«  »	PRINT OK
«-»	MINUS OK
«+»	PLUS OK
«  »	TOGGLE OK
«← »	ENTER OK
«C»	C OK
«→0/T←»	O/T OK

**Sample Printout:**

```

|           -- Key Test --           |
| 21.Jan. 2009           11:34 |
|                               |
| METTLER TOLEDO           |
|                               |
| Balance Type           MS204S |
| SNR:                   1234567890 |
| SW:                     V1.00 |
| 1/10 Key                OK |
| Menu Key                 OK |
| Cal Key                  OK |
| Print Key                OK |
| Plus Key                 OK |
| Toggle Key              OK |
| Enter Key                OK |
| Cancel Key               OK |
| O/T Key                  OK |
| ----- |

```

## 16.4 Motor Test

The motor test allows you to test the calibration motor of the balance.

**Note:** On models with internal weight only.

- a) Press «←|» to start "CAL.MOT. T".  
"RUNNING" is displayed during the Motor Test. A motor test is deemed successful when all the motor positions have been successfully tested. At the end of the test, the test information will be printed.

- b) Press «C» to cancel the test procedure. The balance will return to the topic "DIAGNOSE".
- c) Press «» for printout.

**Sample Printout:**



```

|      -- Motor Test --      |
| 21.Jan. 2009           11:34 |
|                          |
| METTLER TOLEDO          |
|                          |
| Balance Type           MS204S |
| SNR:                   1234567890 |
| SW:                     V1.00 |
| Motor Test              OK |
| -----                |

```

## 16.5 Balance History

The balance history function allows you to view and print the history of the balance.

- a) Press «» to start "BAL.HIST".
- b) Press «» to scroll forward through the displayed list of balance history information.
- c) Press «C» to cancel the test procedure. The balance will return to the topic "DIAGNOSE".
- d) Press «» for printout.

**Sample Information Displayed:**

Information	Display
Operation Time (year:day:hour)	110:321:23
Total load kg (t)	1485.1345 kg
Number of weighings	999999999999
Number of key pressed	999999999999
Number of motor movements	9999999999
Backlight time (year:day:hour)	10:32:23
Next service due date	01:01:2010 dat

**Sample Printout:**

```

|      -- Statistical Info --      |
| 21.Jan. 2009           11:34 |
|                          |
| METTLER TOLEDO          |
|                          |
| Balance Type           MS204S |
| SNR:                   1234567890 |
| Balance ID:            LAB-3 |
| SW                      4.23 |
|                          |

```

```

| Operating hours          |
| 10y 321d 23h          |
| Total weight loaded    |
| 1485.1345 t           |
| Number of weights      |
| 999999999999          |
| Number of key press    |
| 999999999999          |
| Motor movements        |
| 9999999999            |
| Backlight running hours|
| 10y 321d 23h          |
| Next service due date  |
| 01.01.2010            |
| -----              |

```

## 16.6 Calibration History

The "Calibration History" function allows you to view and print information on the last 30 (thirty) balance adjustment. Adjustments made by a service technician and normal user are counted together.

- Press «←|» to start "CAL.HIST".
- Press «←|» key to scroll forward through the displayed list of Adjustments history information.
- Press «C» to cancel the test procedure. The balance will return to the topic "DIAGNOSE".
- Press «≡» for printout.

### Sample Information Displayed:

Note	Display
S = External adjusted service	06:03:09 S
I = Internal adjusted	05:03:09 I
	.
	.
	.
F = FACT	04:03:09 F
I = Internal adjusted	03:03:09 I
E = External adjusted user	02:03:09 E
I = Internal adjusted	05:03:09 I

### Sample Printout:

```

| ----- Calibration ----- |
| 05.Mar. 2009          11:34 |
|                       |
| METTLER TOLEDO      |
|                       |
| Balance Type          MS204S |
| SNR:                  1234567890 |
| -----              |

```



```

| 01 05.Mar. 2009      11:34 |
| External             |
| ADJ SERVICE      100.0000 g |
|                   23.5°C |
| ----- |
| 02 04.Mar. 2009      09:00 |
| FACT               |
|                   22.4°C |
| ----- |
| .                   |
| .                   |
| .                   |
| 28 03.Mar. 2009     10:59 |
| FACT               |
|                   22.6°C |
| ----- |
| 29 02.Mar. 2009     16:34 |
| External             |
| ADJ USER      100.0000 g |
|                   24.6°C |
| ----- |
| 30 02.Mar. 2009     18:36 |
| FACT               |
|                   22.4°C |
| ----- |

```

## 16.7 Balance Information

The balance information function allows you to view and print information about your balance.

- Press «←|» to start "BAL.INFO".
- Press «←|» to scroll forward through the displayed list of Balance information.
- Press «C» to cancel the test procedure. The balance will return to the topic "DIAGNOSE".

### Sample information displayed:



Information	Display
Balance type	TYPE MS6002S
Max. load	MAX 6200 g
Software platform	PLATFORM RAINBOW
Serial number	SNR 1234567890
Type definition number	TDNR 9.6.3.411.203
Software version	SOFTWARE V1.00
Cell ID	CELL ID 1172400044
Cell type	CELL TYPE MMAI6000G2
Tolerance revision number	TOLERANCE NO2
Language	LANGUAGE ENGLISH

**Sample Printout:**

```
|  -- Balance Information -  |
| 21.Jan. 2009           11:34 |
|                          |
| METTLER TOLEDO        |
|                          |
| Balance Type           MS6002S |
| Max. Load             6200 g |
| SNR:                   1234567890 |
| SW:                    V1.00 |
| Platform               Rainbow |
| TDNR:                   9.6.3.411.2- |
| Cell ID:                03 |
| Cell Type              1172400044 |
| Tol.Rev.no.            MMAI6000G2 |
| Language                2 |
|                          |
| ----- |
```

## 16.8 Service Provider Information

The service provider Information function allows you to print information about your service provider.

- a) Press «» to start "PROVIDER".
- b) Press «». The service provider information will be printed and the balance will return to the topic "DIAGNOSE".



**Sample Printout:**

```
|  -- Service Provider --  |
| 21.Jan. 2009           11:34 |
|                          |
| METTLER TOLEDO        |
| Im Langacher          |
| CH-8606 Greifensee    |
| Switzerland           |
| (+41) 044 944 22 11   |
|                          |
| ----- |
```

## 17 Error and Status Messages

### 17.1 Error Messages

Error messages in the display draw your attention to incorrect operation or that the balance could not execute a procedure properly.

Error Message	Cause	Rectification
NO STABILITY	No stability.	Ensure more stable ambient conditions. If not possible, check settings for environment.
WRONG ADJUSTMENT WEIGHT	Wrong adjustment weight on pan or none at all.	Place required adjustment weight in center of pan.
REFERENCE TOO SMALL	Reference for piece counting too small.	Increase reference weight.
EEPROM ERROR - PLEASE CONTACT CUSTOM SERVICE	EEPROM (memory) error.	Please contact METTLER TOLEDO customer service.
WRONG CELL DATA - PLEASE CONTACT CUSTOM SERVICE	Wrong cell data.	Please contact METTLER TOLEDO customer service.
NO STANDARD ADJUSTMENT - PLEASE CONTACT CUSTOM SERVICE	No standard calibration.	Please contact METTLER TOLEDO customer service.
PROGRAM MEMORY DEFECT - PLEASE CONTACT CUSTOM SERVICE	Program memory defect.	Please contact METTLER TOLEDO customer service.
TEMP SENSOR DEFECT - PLEASE CONTACT CUSTOM SERVICE	Temperature sensor defect.	Please contact METTLER TOLEDO customer service.
WRONG LOAD CELL BRAND - PLEASE CONTACT CUSTOM SERVICE	Wrong load cell brand.	Please contact METTLER TOLEDO customer service.
WRONG TYPE DATA SET - PLEASE CONTACT CUSTOM SERVICE	Wrong type data set.	Please contact METTLER TOLEDO customer service.
	Overload - The weight on the pan exceeds the weighing capacity of the balance.	Reduce the weight on the weighing pan.
	Underload	Check that the weighing pan is positioned correctly.
MEM FULL	Memory full.	Clear the memory and start a new evaluation.
FACTOR OUT OF RANGE	Factor is outside the allow range.	Select a new factor.
STEP OUT OF RANGE	Step is outside the allow range.	Select a new step.
OUT OF RANGE	Sample weight is outside the allow range.	Unload the pan and load a new sample weight.
BELOW ZERO RANGE	Belong zero range.	Check that the weighing pan is positioned correctly.

### 17.2 Status Messages

Status messages are displayed by means of small icons. The status icons indicate the following:

<b>Status Icon</b>	<b>Signification</b>
	Service Reminder Your balance is due for servicing. Contact your dealer's customer service department as soon as possible to have a technician service your balance. (see menu topic "SERV.ICON")

## 18 Cleaning and Service

Every now and then, clean the weighing pan, draft shield element, bottom plate, draft shield (depending on the model) and housing of your balance. Your balance is made from high-quality, durable materials and can therefore be cleaned using a damp cloth or with a standard, mild cleaning agent.

To thoroughly clean the draft shield glass panels, remove the draft shield from the balance. When reinstalling the draft shield, ensure that it is in the correct position.

### Please observe the following notes:



- The balance must be disconnected from the power supply
- Ensure that no liquid comes into contact with the balance or the AC adapter.
- Never open the balance or AC adapter – they contain no components, which can be cleaned, repaired or replaced by the user.



- On no account use cleaning agents, which contains solvents or abrasive ingredients, as this can result in damage to the operation panel overlay.



- Do not clean the IP65 protected models using high-pressure or high-temperature water.

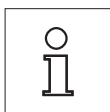

Please contact your METTLER TOLEDO dealer for details of the available service options. Regular servicing by an authorized service engineer ensures constant accuracy for years to come and prolongs the service life of your balance.

### 18.1 Cleaning the Glass Draft Shield (0.1 mg and 1 mg Models)

#### 1 Remove the following parts:

- a) Remove weighing pan, draft shield element (0.1 mg models) and pan support.
- b) Remove the bottom plate.
- c) Unlock the draft shield, lift it off the balance and place it on a clean surface.

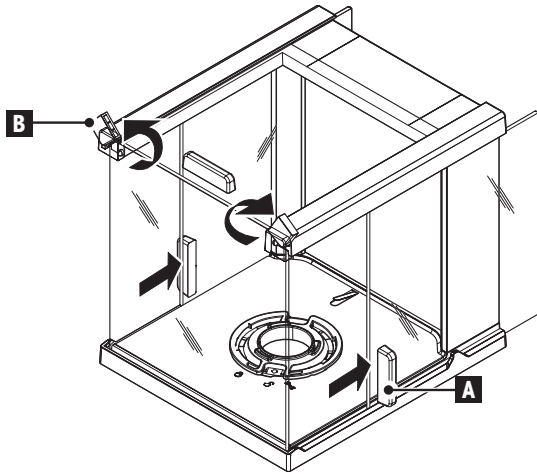

**2**

- a) Push the **glass doors (A)** back.
- b) Turn the two **lock covers (B)** on the front as far as it will go.

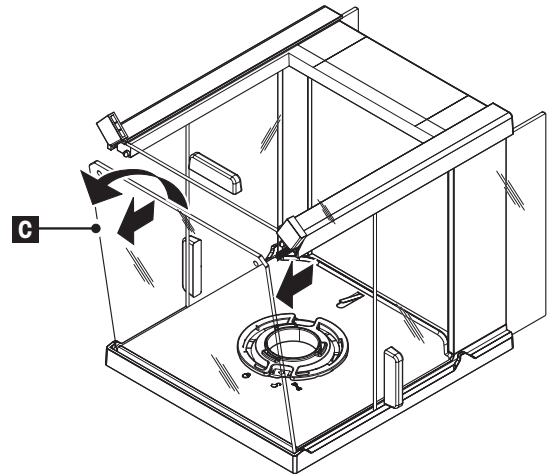

**3**

- a) Tilt the **front glass (C)** forward.
- b) Remove the front-glass.

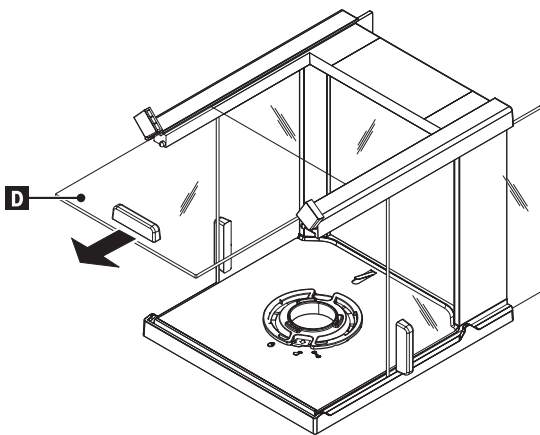

**4**

Pull the **top glass door (D)** out from the front.

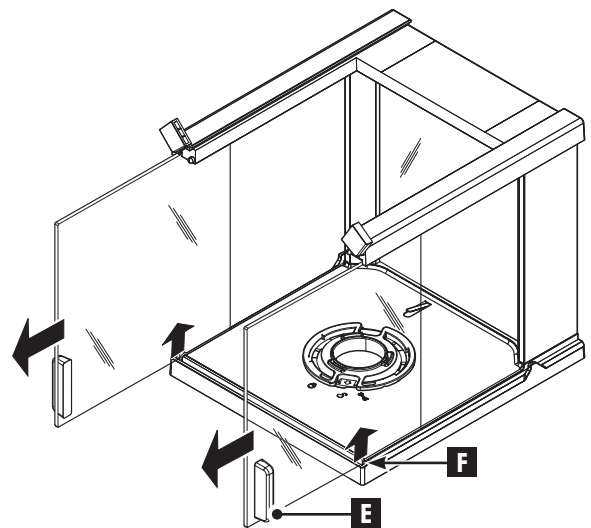

**5**

Lift the **side glass doors (E)** at **(F)** and pull it out from the front.

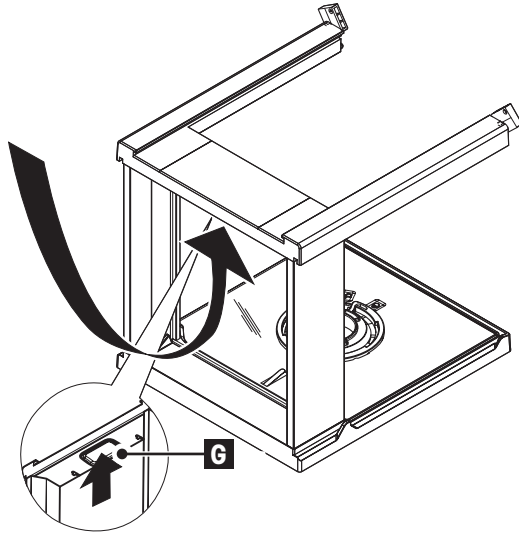

**6**  
Push the lock button (**G**) to release the **rear glass**.

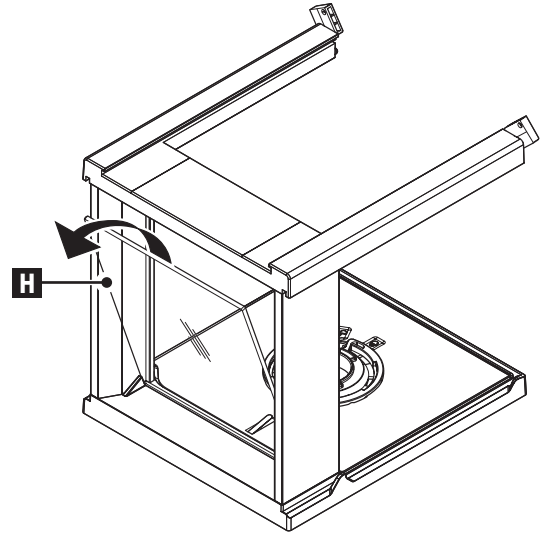

**7**  
Remove the rear glass (**H**).

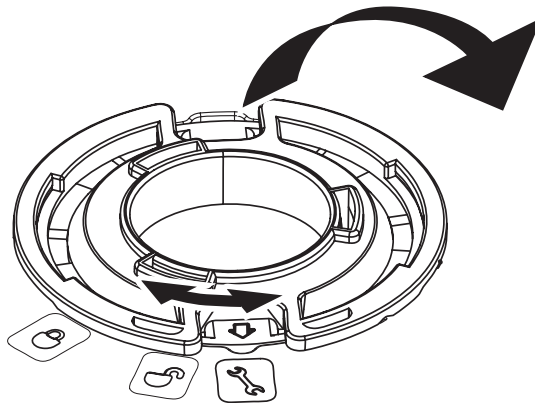

**8**  
a) Turn the **draft shield lock** to the "↶" (Service) position.  
b) Remove the draft shield lock.

**9**  
**After cleaning reinstall all components** in the reverse order. For balance mounting see chapter "Setting up the Balance – Installing the Components".

# 19 Interface Specification

## 19.1 RS232C Interface

Each balance is equipped with an RS232C Interface as standard for the attachment of a peripheral device (e.g. printer or computer).

Schematic	Item	Specification
	Interface type	Voltage interface according to EIA RS-232C/DIN66020 CCITT V24/V.28)
	Max. cable length	15 m
	Signal level	Outputs: +5 V ... +15 V (RL = 3–7 kΩ) –5 V ... –15 V (RL = 3–7 kΩ) Inputs: +3 V ... +25 V –3 V ... –25 V
	Connector	Sub-D, 9-pole, female
	Operating mode	Full duplex
	Transmission mode	Bit-serial, asynchronous
	Transmission code	ASCII
	Baude rates	300, 1200, 2400, 4800, 9600, 19200, 38400 (software selectable)
	Bits/parity	7-bit/none, 7-bit/even, 7-bit/odd, 8-bit/none (software selectable)
	Stop bits	1 stop bit
	Handshake	None, XON/XOFF, RTS/CTS (software selectable)
	End-of-line	<CR><LF>, <CR>, <LF> (software selectable)

## 19.2 USB Device Interface

Each balance is equipped with an "USB Device" Interface as standard for the attachment of a peripheral device (e.g. computer).

**Note:** This interface is not suitable to communicate with a Printer.

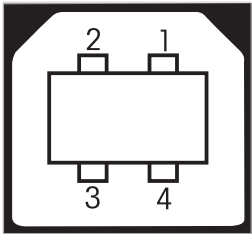

Schematic	Item	Specification										
 <table border="1" data-bbox="368 525 654 691"> <tbody> <tr> <td>1</td> <td>VBUS (+5 VDC)</td> </tr> <tr> <td>2</td> <td>D- (Data -)</td> </tr> <tr> <td>3</td> <td>D+ (Data +)</td> </tr> <tr> <td>4</td> <td>GND (Ground)</td> </tr> <tr> <td>Shield</td> <td>Shield</td> </tr> </tbody> </table>	1	VBUS (+5 VDC)	2	D- (Data -)	3	D+ (Data +)	4	GND (Ground)	Shield	Shield	Standard	In conformity with USB Specification Revision 1.1
	1	VBUS (+5 VDC)										
	2	D- (Data -)										
	3	D+ (Data +)										
	4	GND (Ground)										
Shield	Shield											
Speed	Full speed 12 Mbps (requires shielded cable)											
Function	CDC (Communication Device Class) serial port emulation											
Power usage	Suspended device: Max 10 mA											
Connector	Type B											

## 19.3 MT-SICS Interface Commands and Functions

Many of the balances and scales used have to be capable of integration in a complex computer or data acquisition system.

To enable you to integrate balances in your system in a simple manner and utilize their capabilities to the full, most balance functions are also available as appropriate commands via the data interface.

All new METTLER TOLEDO balances launched on the market support the standardized command set "METTLER TOLEDO Standard Interface Command Set" (MT-SICS). The commands available depend on the functionality of the balance.

### Basic information on data interchange with the balance

The balance receives commands from the system and acknowledges the command with an appropriate response.

### Command formats

Commands sent to the balance comprised one or more characters of the ASCII character set. Here, the following must be noted:

- Enter commands only in uppercase.
- The possible parameters of the command must be separated from one another and from the command name by a space (ASCII 32 dec., in this description represented as `␣`).
- The possible input for "text" is a sequence of characters of the 8-bit ASCII character set from 32 dec to 255 dec.
- Each command must be closed by `CRLF` (ASCII 13 dec., 10 dec.). The characters `CRLF`, which can be inputted using the Enter or Return key of most entry keypads, are not listed in this description, but it is essential they be included for communication with the balance.

### Example

#### S – Send stable weight value

Command	<code>s</code>	Get the current stable net weight value.
Response	<code>S␣S␣WeightValue␣Unit</code>	Current stable weight value in unit actually set under unit 1.

<b>S<sub>L</sub>I</b>	Command not executable (balance is currently executing another command, e.g. taring, or timeout as stability was not reached).
<b>S<sub>L</sub>+</b>	Balance in overload range.
<b>S<sub>L</sub>-</b>	Balance in underload range.

**Example**

Command	<b>s</b>	Query a stable weight value.
Response	<b>S<sub>L</sub>S<sub>L</sub> 100.00<sub>g</sub></b>	The current stable weight value is 100.00 g.

The available MT-SICS commands are listed in the table. For further information please refer to the Reference Manual "MT-SICS 11780711" downloadable from the Internet under [www.mt.com/sics-newclassic](http://www.mt.com/sics-newclassic).



	Description		Description
<b>@</b>	Cancel (Reset)	<b>M31</b>	Mode after restart
<b>C0</b>	Query/Set adjustment settings	<b>M46</b>	Print interval
<b>C1</b>	Start adjustment according to current settings	<b>PW</b>	Piece counting: Query/Set piece weight
<b>C2</b>	Start adjustment with external weight	<b>PWR</b>	Power on/off (PWR 0 means switch off completely, if balance is powered by battery)
<b>C3</b>	Start adjustment with internal weight	<b>S</b>	Send stable weight value
<b>D</b>	Display text sent to balance	<b>SI</b>	Send weight value immediately
<b>DAT</b>	Date query/set	<b>SIR</b>	Send weight value immediately and repeat
<b>DW</b>	Display weigh	<b>SIRU</b>	Send weight value with currently displayed unit immediately and repeat
<b>I0</b>	Commands implemented	<b>SIU</b>	Send weight value with currently displayed unit immediately
<b>I1</b>	MT-SICS level and MT-SICS versions	<b>SM0</b>	Dynamic weighing: cancel all SMx commands
<b>I2</b>	Balance data	<b>SM1</b>	Dynamic weighing: Start immediately and send the result
<b>I3</b>	Software version, type definition number	<b>SM2</b>	Dynamic weighing: start after a minimum load is exceeded and send result
<b>I4</b>	Query serial number (SNR)	<b>SM3</b>	Dynamic weighing: start after a minimum load is exceeded, send result and repeat
<b>I5</b>	Query SW-identification number	<b>SM4</b>	Dynamic weighing: query/set time interval
<b>I10</b>	Query balance ID	<b>SNR</b>	Send stable weight value and repeat on weight change
<b>I11</b>	Query balance type	<b>SNRU</b>	Send stable weight value with currently displayed unit and repeat on weight change
<b>I14</b>	Query balance information	<b>SR</b>	Send weight value on weight change
<b>K</b>	Keys: set configuration	<b>SRU</b>	Send stable weight value with currently displayed unit on weight change
<b>M02</b>	Query/set environment	<b>ST</b>	Send stable weight value on pressing (print) key
<b>M03</b>	Query/set AutoZero	<b>SU</b>	Send stable weight value with currently displayed unit
<b>M08</b>	Display brightness	<b>T</b>	Tare
<b>M09</b>	Display contrast	<b>TA</b>	Get/Set tare weight value
<b>M11</b>	Beeper: Query/set volume	<b>TAC</b>	Clear tare value
<b>M14</b>	List available language	<b>TI</b>	Tare immediately

	Description		Description
<b>M15</b>	Query/set language	<b>TIM</b>	Query/set time
<b>M17</b>	FACT: query/set single time criteria (no possibility to set "weekday", 0 and 127)	<b>TST0</b>	Query/set test function settings
<b>M22</b>	Custom unit definition remarks: only one custom unit available, no possibility to set "name" of unit	<b>TST1</b>	Start test function according to current settings
<b>M25</b>	Get application list	<b>TST2</b>	Start test function with external weight
<b>M26</b>	Get/set current application	<b>TST3</b>	Start test function with internal weight
<b>M27</b>	Adjustment history	<b>UPD</b>	Query/set update rate of the host interface
<b>M30</b>	+/- settings with nominal and tolerance	<b>Z</b>	Zero
		<b>ZI</b>	Zero immediately

## 20 Technical Data

### 20.1 General Data

#### Power Supply

- S Platform:
  - AC/DC Adapter
  - Primary: 100V–240V, 50/60Hz, 0.3 A
  - Secondary: 12VDC, 0.84A (with electronic overload protection)
  - Power supply to the balance: 11–20VDC, 10W
  -  Use only with a tested AC Adapter with SELV output current.  
Ensure correct polarity  — 
- L Platform:
  - Power supply 100V–240V, 50/60Hz, 0.3 A
  - Power cable 2-core with country-specific plug
  - MS-KL models: Built-in rechargeable NiMH battery (nickel-metal hydride)

#### Protection and Standards

- Overvoltage categorie: Class II
- Degree of pollution: 2
- Degree of Protection: Protected against dust and water  
Models with S + L Platform: IP54 in use with weighing pan  
MS-KLIP models: IP65
- Standards for safety and EMC: See Declaration of Conformity
- Range of application: For use only in enclosed interior rooms

#### Environmental conditions

- Heigh above mean sea level: up to 4000 m
- Ambient temperature range: 10 to 30 °C (S platform)  
5 to 40 °C (L platform, MS-L models)  
-10 to 40 °C (L platform, MS-KL models)
- Relative air humidity: 10% to 80 % at 31 °C, linearly decreasing to 50 % at 40 °C, noncondensing

#### Materials

- Housing: Die-cast aluminum, lacquered
- Weighing pan: Stainless steel X2CrNiMo 17-12-3 (1.4404)  
245 x 351 mm: Stainless steel X5CrNiMo 18-10 (1.4301)
- Draft shield element: with 0.1 mg models: Stainless steel X2CrNiMo 17-12-3 (1.4404)  
with 10 mg models: Plastic (PBT)
- Draft shield: Plastic (PBT), glass
- In-use-cover: Plastic (PBT)

## 20.2 Model-Specific Data

### 20.2.1 Balances with Readability of 0.1 mg, S Platform with Draft Shield

#### Technical Data

Model	MS104S	M204S	MS304S
Maximum load	120 g	220 g	320 g
Maximum load, fine range	–	–	–
Readability	0.1 mg	0.1 mg	0.1 mg
Readability, fine range	–	–	–
Taring range	0...120 g	0...220 g	0...320 g
Repeatability (sd)	0.1 mg	0.1 mg	0.1 mg
Repeatability (sd), fine range	–	–	–
Linearity	0.2 mg	0.2 mg	0.3 mg
Linearity, fine range	–	–	–
Sensitivity temperature drift (10...30°C)	1.5 ppm/°C	1.5 ppm/°C	1.5 ppm/°C
Eccentric load deviation (test load)	0.2 mg (50 g)	0.3 mg (100 g)	0.3 mg (200 g)
Internal adjustment	yes, FACT	yes, FACT	yes, FACT
Adjustment range with external weights	50...120 g	100...220 g	100...320 g
Weights for routine testing			
Large Weight/Class OIML/ASTM	100 g / F2/4	200 g / F2/4	200 g / F2/4
Small Weight/Class OIML/ASTM	5 g / E2/2	10 g / F1/3	10 g / F1/3
Minimum weight (acc. to USP)	0.3 g	0.3 g	0.3 g
Minimum weight (U=1%, k=2)	0.02 g	0.02 g	0.02 g
Minimum weight (OIML)	0.01 g	0.01 g	0.01 g
Settling time, typ.	2 s	2 s	3 s
Weighing technology	MonoBloc	MonoBloc	MonoBloc
Usable height of draftshield [mm]	237	237	237
Weighing pan dimensions (WxD) [mm]	Ø 90	Ø 90	Ø 90
Balance dimensions (WxDxH) [mm]	204x347x345	204x347x345	204x347x345
Net Weight [kg]	6.5	6.5	6.5

### 20.2.2 Balances with Readability of 1 mg, S Platform with Draft Shield

#### Technical Data

Model	MS303S	MS303SE	MS403S
Maximum load	320 g	320 g	420 g
Maximum load, fine range	–	–	–
Readability	0.001 g	0.001 g	0.001 g
Readability, fine range	–	–	–
Taring range	0...320 g	0...320 g	0...420 g
Repeatability (sd)	0.001 g	0.001 g	0.001 g
Repeatability (sd), fine range	–	–	–
Linearity	0.002 g	0.002 g	0.002 g
Linearity, fine range	–	–	–
Sensitivity temperature drift (10...30°C)	3 ppm/°C	3 ppm/°C	3 ppm/°C

<b>Model</b>	<b>MS303S</b>	<b>MS303SE</b>	<b>MS403S</b>
Eccentric load deviation (test load)	3 mg (200 g)	3 mg (200 g)	3 mg (200 g)
Internal adjustment	yes, FACT	no, EXT ADJ	yes, FACT
Adjustment range with external weights	100...320 g	100...320 g	100...420 g
Weights for routine testing			
Large Weight/Class OIML/ASTM	200 g / F2/4	200 g / F2/4	200 g / F2/4
Small Weight/Class OIML/ASTM	10 g / F1/3	10 g / F1/3	20 g / F1/3
Minimum weight (acc. to USP)	3 g	3 g	3 g
Minimum weight (U=1%, k=2)	0.2 g	0.2 g	0.2 g
Minimum weight (OIML)	0.02 g	0.02 g	0.02 g
Settling time, typ.	1.5 s	1.5 s	1.5 s
Weighing technology	MonoBloc	MonoBloc	MonoBloc
Usable height of draftshield [mm]	165	165	165
Weighing pan dimensions (WxD) [mm]	127x127	127x127	127x127
Balance dimensions (WxDxH) [mm]	204x347x280	204x347x280	204x347x280
Net Weight [kg]	6.2	6.2	6.2

<b>Model</b>	<b>MS603S</b>	<b>MS1003S</b>
Maximum load	620 g	1020 g
Maximum load, fine range	–	–
Readability	0.001 g	0.001 g
Readability, fine range	–	–
Taring range	0...620 g	0...1020 g
Repeatability (sd)	0.001 g	0.001 g
Repeatability (sd), fine range	–	–
Linearity	0.002 g	0.002 g
Linearity, fine range	–	–
Sensitivity temperature drift (10...30°C)	3 ppm/°C	3 ppm/°C
Eccentric load deviation (test load)	3 mg (200 g)	3 mg (500 g)
Internal adjustment	yes, FACT	yes, FACT
Adjustment range with external weights	100...620 g	500...1020 g
Weights for routine testing		
Large Weight/Class OIML/ASTM	500 g / F2/4	1000 g / F2/4
Small Weight/Class OIML/ASTM	20 g / F1/3	50 g / F2/4
Minimum weight (acc. to USP)	3 g	3 g
Minimum weight (U=1%, k=2)	0.2 g	0.2 g
Minimum weight (OIML)	0.02 g	0.02 g
Settling time, typ.	1.5 s	1.5 s
Weighing technology	MonoBloc	MonoBloc
Usable height of draftshield [mm]	165	165
Weighing pan dimensions (WxD) [mm]	127x127	127x127
Balance dimensions (WxDxH) [mm]	204x347x280	204x347x280
Net Weight [kg]	6.2	6.9

## 20.2.3 Balances with Readability of 0.01 g, S Platform

### Technical Data

Model	MS1602S	MS1602SE	MS3002S
Maximum load	1620 g	1620 g	3200 g
Maximum load, fine range	–	–	–
Readability	0.01 g	0.01 g	0.01 g
Readability, fine range	–	–	–
Taring range	0...1620 g	0...1620 g	0...3200 g
Repeatability (sd)	0.01 g	0.01 g	0.01 g
Repeatability (sd), fine range	–	–	–
Linearity	0.02 g	0.02 g	0.02 g
Linearity, fine range	–	–	–
Sensitivity temperature drift (10...30°C)	3 ppm/°C	3 ppm/°C	3 ppm/°C
Eccentric load deviation (test load)	30 mg (1000 g)	30 mg (1000 g)	30 mg (2000 g)
Internal adjustment	yes, FACT	no, EXT ADJ	yes, FACT
Adjustment range with external weights	1000...1620 g	1000...1620 g	1000...3200 g
Weights for routine testing			
Large Weight/Class OIML/ASTM	1000 g / F2/4	1000 g / F2/4	1000 g / F2/4
Small Weight/Class OIML/ASTM	50 g / F2/4	50 g / F2/4	100 g / F2/4
Minimum weight (acc. to USP)	30 g	30 g	30 g
Minimum weight (U=1%, k=2)	2 g	2 g	2 g
Minimum weight (OIML)	0.5 g	0.5 g	0.5 g
Settling time, typ.	1.5 s	1.5 s	1.5 s
Weighing technology	MonoBloc	MonoBloc	MonoBloc
Weighing pan dimensions (WxD) [mm]	170x200	170x200	170x200
Balance dimensions (WxDxH) [mm]	194x347x97	194x347x97	194x347x97
Net Weight [kg]	5.5	5.5	5.5

Model	MS3002SE	MS4002S	MS4002SDR
Maximum load	3200 g	4200 g	4200 g
Maximum load, fine range	–	–	820 g
Readability	0.01 g	0.01 g	0.1 g
Readability, fine range	–	–	0.01 g
Taring range	0...3200 g	0...4200 g	0...4200 g
Repeatability (sd)	0.01 g	0.01 g	0.06 g
Repeatability (sd), fine range	–	–	0.01
Linearity	0.02 g	0.02 g	0.2 g
Linearity, fine range	–	–	0.02 g
Sensitivity temperature drift (10...30°C)	3 ppm/°C	3 ppm/°C	3 ppm/°C
Eccentric load deviation (test load)	30 mg (2000 g)	30 mg (2000 g)	30 mg (2000 g)
Internal adjustment	no, EXT ADJ	yes, FACT	yes, FACT
Adjustment range with external weights	1000...3200 g	1000...4200 g	1000...4200 g
Weights for routine testing			
Large Weight/Class OIML/ASTM	1000 g / F2/4	2000 g / F2/4	2000 g / F2/4
Small Weight/Class OIML/ASTM	100 g / F2/4	200 g / F2/4	200 g / F2/4
Minimum weight (acc. to USP)	30 g	30 g	30 g
Minimum weight (U=1%, k=2)	2 g	2 g	2 g

Model	MS3002SE	MS4002S	MS4002SDR
Minimum weight (OIML)	0.5 g	0.5 g	0.5 g
Settling time, typ.	1.5 s	1.5 s	1.5 s
Weighing technology	MonoBloc	MonoBloc	MonoBloc
Weighing pan dimensions (WxD) [mm]	170x200	170x200	170x200
Balance dimensions (WxDxH) [mm]	194x347x97	194x347x97	194x347x97
Net Weight [kg]	5.5	5.5	5.5

Model	MS6002S	MS6002SDR
Maximum load	6200 g	6200 g
Maximum load, fine range	–	1200 g
Readability	0.01 g	0.1 g
Readability, fine range	–	0.01 g
Taring range	0...6200 g	0...6200 g
Repeatability (sd)	0.01 g	0.06 g
Repeatability (sd), fine range	–	0.01 g
Linearity	0.02 g	0.2 g
Linearity, fine range	–	0.02 g
Sensitivity temperature drift (10...30°C)	3 ppm/°C	3 ppm/°C
Eccentric load deviation (test load)	30 mg (2000 g)	30 mg (2000 g)
Internal adjustment	yes, FACT	yes, FACT
Adjustment range with external weights	2000...6200 g	2000...6200 g
Weights for routine testing		
Large Weight/Class OIML/ASTM	5000 g / F2/4	5000 g / F2/4
Small Weight/Class OIML/ASTM	200 g / F2/4	200 g / F2/4
Minimum weight (acc. to USP)	30 g	30 g
Minimum weight (U=1%, k=2)	2 g	2 g
Minimum weight (OIML)	0.5 g	0.5 g
Settling time, typ.	1.2 s	1.2 s
Weighing technology	MonoBloc	MonoBloc
Weighing pan dimensions (WxD) [mm]	170x200	170x200
Balance dimensions (WxDxH) [mm]	194x347x97	194x347x97
Net Weight [kg]	5.3	5.3

## 20.2.4 Balances with Readability of 0.1 g, S Platform

### Technical Data

Model	MS6001S	MS8001S	MS8001SE
Maximum load	6200 g	8200 g	8200 g
Maximum load, fine range	–	–	–
Readability	0.1 g	0.1 g	0.1 g
Readability, fine range	–	–	–
Taring range	0...6200 g	0...8200 g	0...8200 g
Repeatability (sd)	0.1 g	0.1 g	0.1 g
Repeatability (sd), fine range	–	–	–
Linearity	0.2 g	0.2 g	0.2 g
Linearity, fine range	–	–	–



Model	MS6001S	MS8001S	MS8001SE
Sensitivity temperature drift (10...30°C)	5 ppm/°C	5 ppm/°C	15 ppm/°C
Eccentric load deviation (test load)	0.2 g (2000 g)	0.2 g (5000 g)	0.2 g (5000 g)
Internal adjustment	yes, FACT	yes, FACT	no, EXT ADJ
Adjustment range with external weights	2000...6200 g	2000...8200 g	2000...8200 g
Weights for routine testing			
Large Weight/Class OIML/ASTM	5000 g / F2/4	5000 g / F2/4	5000 g / F2/4
Small Weight/Class OIML/ASTM	200 g / F2/4	200 g / F2/4	200 g / F2/4
Minimum weight (acc. to USP)	300 g	300 g	300 g
Minimum weight (U=1%, k=2)	20 g	20 g	20 g
Minimum weight (OIML)	5 g	5 g	5 g
Settling time, typ.	1 s	1 s	1 s
Weighing technology	MonoBloc	MonoBloc	MonoBloc
Weighing pan dimensions (WxD) [mm]	190x226	190x226	190x226
Balance dimensions (WxDxH) [mm]	194x347x97	194x347x97	194x347x97
Net Weight [kg]	5.6	5.6	5.6

## 20.2.5 Balances with Readability of 0.1 g to 1 g, L Platform

### Technical Data

Model	MS12001L	MS16001L	MS16001LE
Maximum load	12200 g	16200 g	16200 g
Maximum load, fine range	–	–	–
Readability	0.1 g	0.1 g	0.1 g
Readability, fine range	–	–	–
Taring range	0...12200 g	0...16200 g	0...16200 g
Repeatability (sd)	0.1 g	0.1 g	0.1 g
Repeatability (sd), fine range	–	–	–
Linearity	0.2 g	0.2 g	0.2 g
Linearity, fine range	–	–	–
Sensitivity temperature drift (10...30°C)	5 ppm/°C	5 ppm/°C	15 ppm/°C
Eccentric load deviation (test load)	0.3 g (5000 g)	0.3 g (5000 g)	0.3 g (5000 g)
Internal adjustment	yes, FACT	yes, FACT	no, EXT ADJ
Adjustment range with external weights	5000...12200 g	5000...16200 g	5000...16200 g
Weights for routine testing			
Large Weight/Class OIML/ASTM	10000 g / F2/4	10000 g / F2/4	10000 g / F2/4
Small Weight/Class OIML/ASTM	500 g / F2/4	500 g / F2/4	500 g / F2/4
Minimum weight (acc. to USP)	300 g	300 g	300 g
Minimum weight (U=1%, k=2)	20 g	20 g	20 g
Minimum weight (OIML)	5 g	5 g	5 g
Settling time, typ.	2 s	2 s	2 s
Weighing technology	MonoBloc	MonoBloc	MonoBloc
Built-in battery	no	no	no
Weighing below the balance (with optional hook)	yes	yes	yes
Weighing pan dimensions (WxD) [mm]	351x245	351x245	351x245
Balance dimensions (WxDxH) [mm]	363x346x118	363x346x118	363x346x118
Net Weight [kg]	10.7	10.7	10.7

<b>Model</b>	<b>MS32001L</b>	<b>MS32001LE</b>
Maximum load	32200 g	32200 g
Maximum load, fine range	–	–
Readability	0.1 g	0.1 g
Readability, fine range	–	–
Taring range	0...32200 g	0...32200 g
Repeatability (sd)	0.1 g	0.1 g
Repeatability (sd), fine range	–	–
Linearity	0.3 g	0.3 g
Linearity, fine range	–	–
Sensitivity temperature drift (10...30°C)	5 ppm/°C	15 ppm/°C
Eccentric load deviation (test load)	0.3 g (5000 g)	0.3 g (5000 g)
Internal adjustment	yes, FACT	no, EXT ADJ
Adjustment range with external weights	10000...32200 g	10000...32200 g
Weights for routine testing		
Large Weight/Class OIML/ASTM	10000 g / F2/4	10000 g / F2/4
Small Weight/Class OIML/ASTM	500 g / F2/4	500 g / F2/4
Minimum weight (acc. to USP)	300 g	300 g
Minimum weight (U=1%, k=2)	20 g	20 g
Minimum weight (OIML)	5 g	5 g
Settling time, typ.	1.5 s	1.5 s
Weighing technology	MonoBloc	MonoBloc
Built-in battery	no	no
Weighing below the balance (with optional hook)	yes	yes
Weighing pan dimensions (WxD) [mm]	351x245	351x245
Balance dimensions (WxDxH) [mm]	363x346x118	363x346x118
Net Weight [kg]	10.7	10.7

<b>Model</b>	<b>MS32000L</b>	<b>MS32000LE</b>
Maximum load	32200 g	32200 g
Maximum load, fine range	–	–
Readability	1 g	1 g
Readability, fine range	–	–
Taring range	0...32200 g	0...32200 g
Repeatability (sd)	0.5 g	0.5 g
Repeatability (sd), fine range	–	–
Linearity	1 g	1 g
Linearity, fine range	–	–
Sensitivity temperature drift (10...30°C)	5 ppm/°C	15 ppm/°C
Eccentric load deviation (test load)	1 g (10000 g)	1 g (10000 g)
Internal adjustment	yes, FACT	no, EXT ADJ
Adjustment range with external weights	10000...32200 g	10000...32200 g
Weights for routine testing		
Large Weight/Class OIML/ASTM	20000 g / F2/4	20000 g / F2/4
Small Weight/Class OIML/ASTM	1000 g / F2/4	1000 g / F2/4
Minimum weight (acc. to USP)	1500 g	1500 g
Minimum weight (U=1%, k=2)	100 g	100g

<b>Model</b>	<b>MS32000L</b>	<b>MS32000LE</b>
Minimum weight (OIML)	50 g	50 g
Settling time, typ.	1.5 s	1.5 s
Weighing technology	MonoBloc	MonoBloc
Built-in battery	no	no
Weighing below the balance (with optional hook)	yes	yes
Weighing pan dimensions (WxD) [mm]	351x245	351x245
Balance dimensions (WxDxH) [mm]	363x346x118	363x346x118
Net Weight [kg]	10.7	10.6

## 20.2.6 Balances with Readability of 2 g to 5 g, L Platform

### Technical Data

<b>Model</b>	<b>MS15KLE</b>	<b>MS15KLIPE</b>
Maximum load	15 kg	15 kg
Readability	2 g	2 g
Weighing range(approved version)	6 kg / 15 kg	6 kg / 15 kg
Readability(approved version)	2 g / 5 g	2 g / 5 g
Taring range	0...15 kg	0...15 kg
Repeatability (sd)	1 g	1 g
Linearity	2 g	2 g
Internal adjustment	no, EXT ADJT	no, EXT ADJ
Adjustment range with external weights	5...15 kg	5...15 kg
Weights for routine testing		
Large Weight/Class OIML/ASTM	10 kg / F2/4	10 kg / F2/4
Small Weight/Class OIML/ASTM	500 g / F2/4	500 g / F2/4
Settling time, typ.	1 s	1 s
Weighing technology	Strain Gauge	Strain Gauge
Weighing pan dimensions (WxD) [mm]	351x245	351x245
Built-in battery	yes	yes
IP Protection	IP 54 in use	IP 65
Weighing below the balance (with optional hook)	no	no
Balance dimensions (WxDxH) [mm]	363x346x122	363x346x122
Net Weight [kg]	9.9	9.9

<b>Model</b>	<b>MS24KLIPE</b>	<b>MS30KLE</b>
Maximum load	24 kg	30 kg
Readability	2 g	2 g
Weighing range(approved version)	15 kg / 24 kg	15 kg / 30 kg
Readability(approved version)	5 g / 10 g	5 g / 10 g
Taring range	0...24 kg	0...30 kg
Repeatability (sd)	2 g	2 g
Linearity	2 g	2 g
Internal adjustment	no, EXT ADJT	no, EXT ADJ
Adjustment range with external weights	10...24 kg	10...30 kg

<b>Model</b>	<b>MS24KLIPE</b>	<b>MS30KLE</b>
Weights for routine testing		
Large Weight/Class OIML/ASTM	20 kg / F2/4	20 kg / F2/4
Small Weight/Class OIML/ASTM	1000 g / F2/4	1000 g / F2/4
Settling time, typ.	1 s	1 s
Weighing technology	Strain Gauge	Strain Gauge
Weighing pan dimensions (WxD) [mm]	351x245	351x245
Built-in battery	yes	yes
IP Protection	IP 65	IP 54 in use
Weighing below the balance (with optional hook)	no	no
Balance dimensions (WxDxH) [mm]	363x346x122	363x346x122
Net Weight [kg]	9.9	9.9

## 20.3 Dimensions

### 20.3.1 Balances with Readability of 0.1 mg, S Platform With Draft Shield

**Models:**

MS104S

MS204S

MS304S

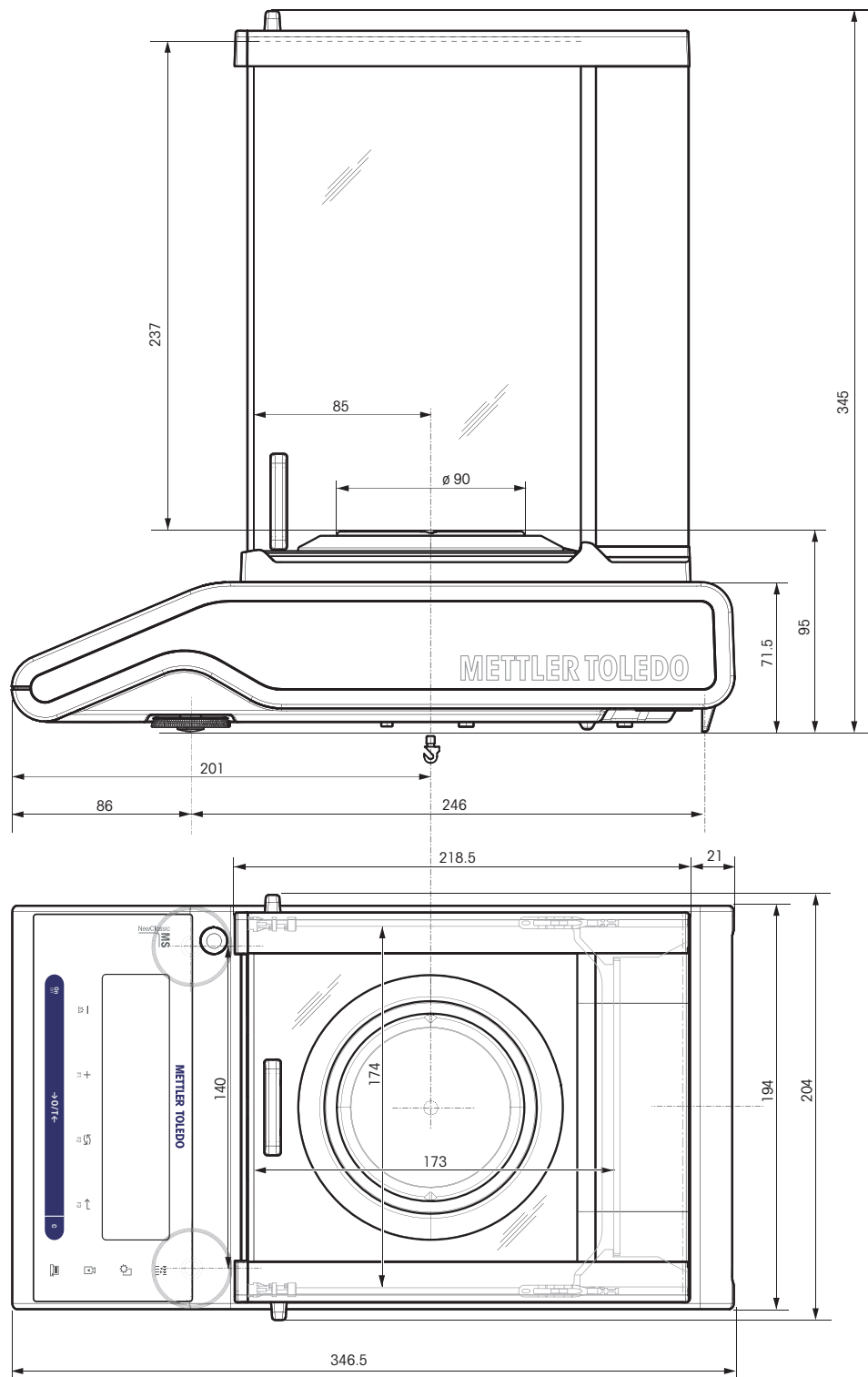

### 20.3.2 Balances with Readability of 1 mg, S Platform With Draft Shield

- Models:**  
 MS303S  
 MS303SE  
 MS403S  
 MS603S  
 MS1003S

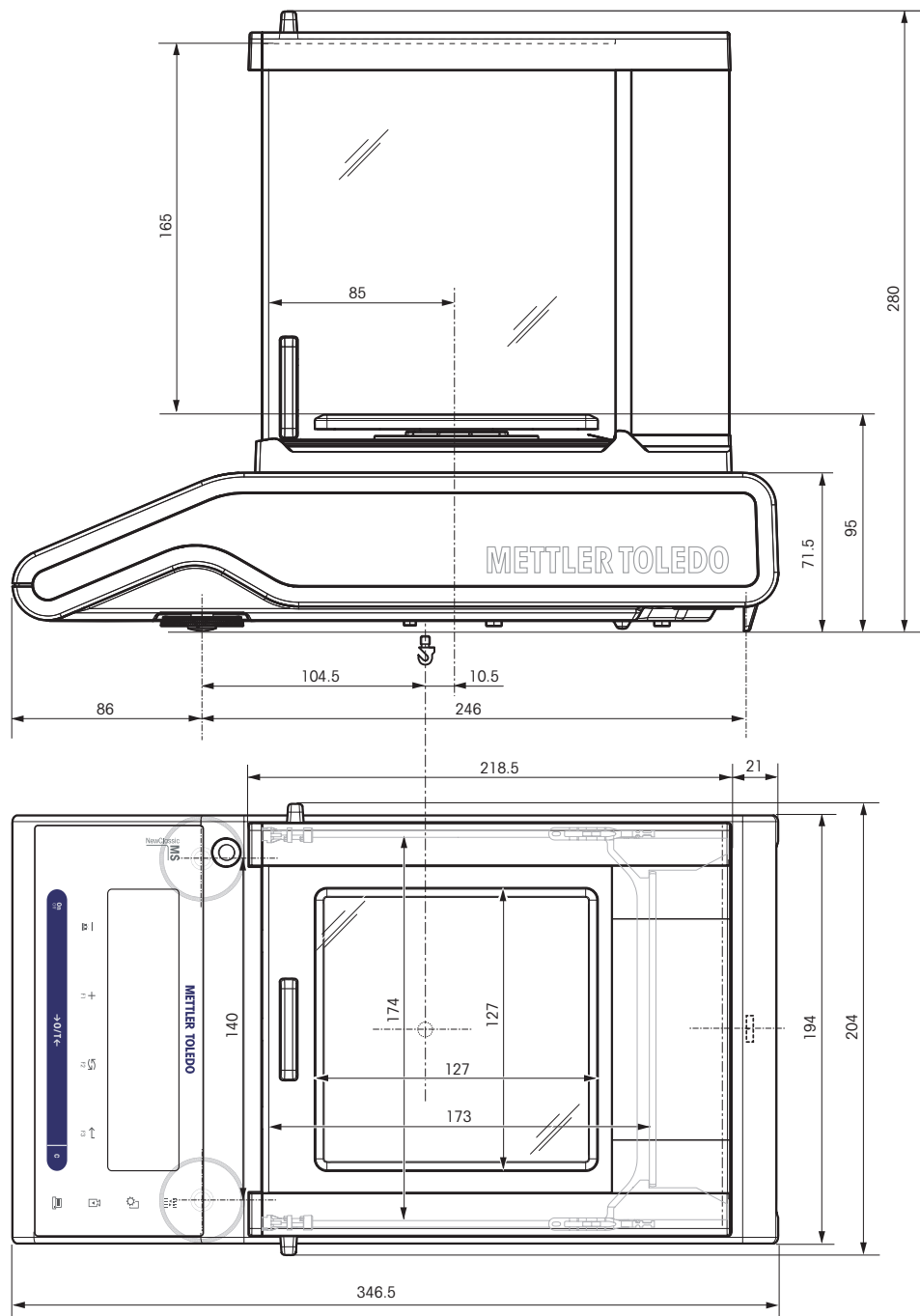

### 20.3.3 Balances with Readability of 0.01 g, S Platform

**Models:**

- MS1602S
- MS1602SE
- MS3002S
- MS3002SE
- MS4002S
- MS4002SDR
- MS6002S
- MS6002SDR

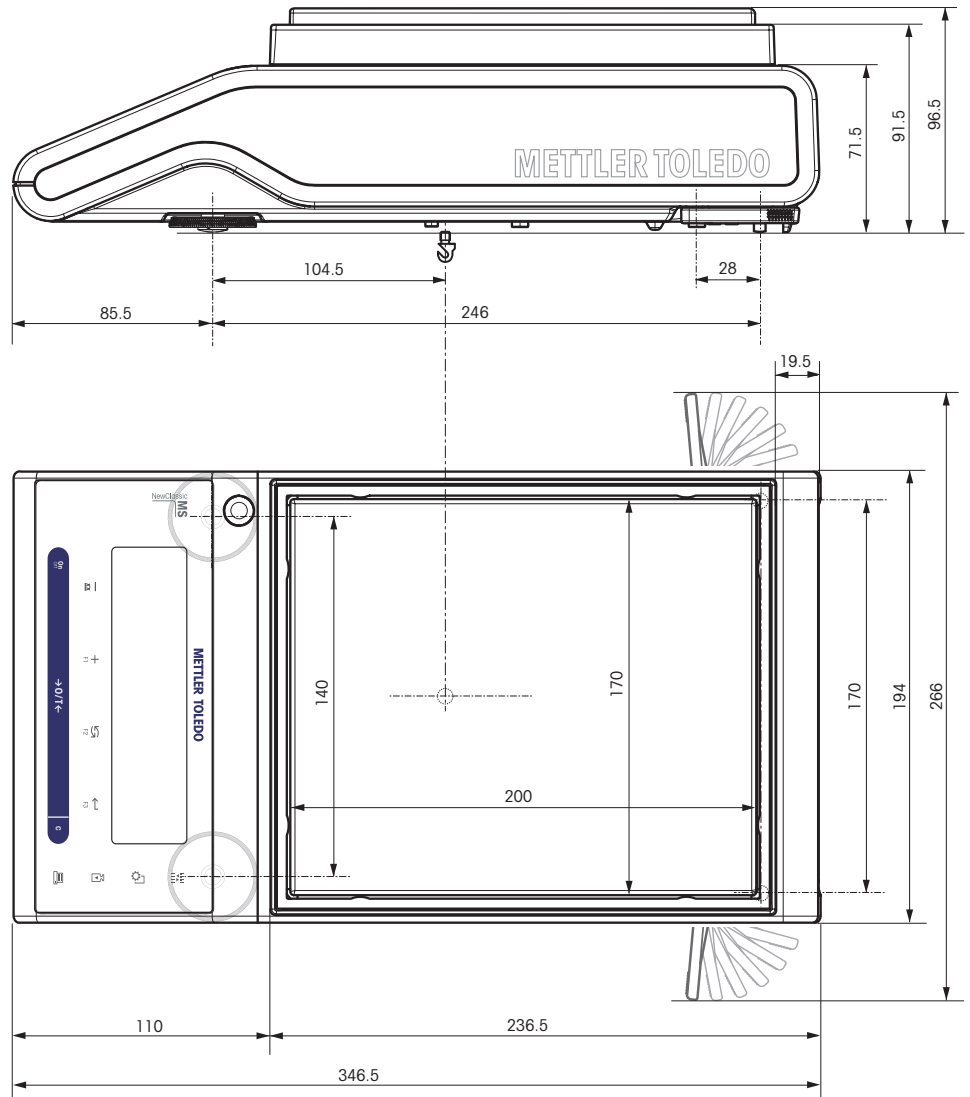

### 20.3.4 Balances with Readability of 0.1 g, S Platform

**Models:**  
 MS6001S  
 MS8001S  
 MS8001SE

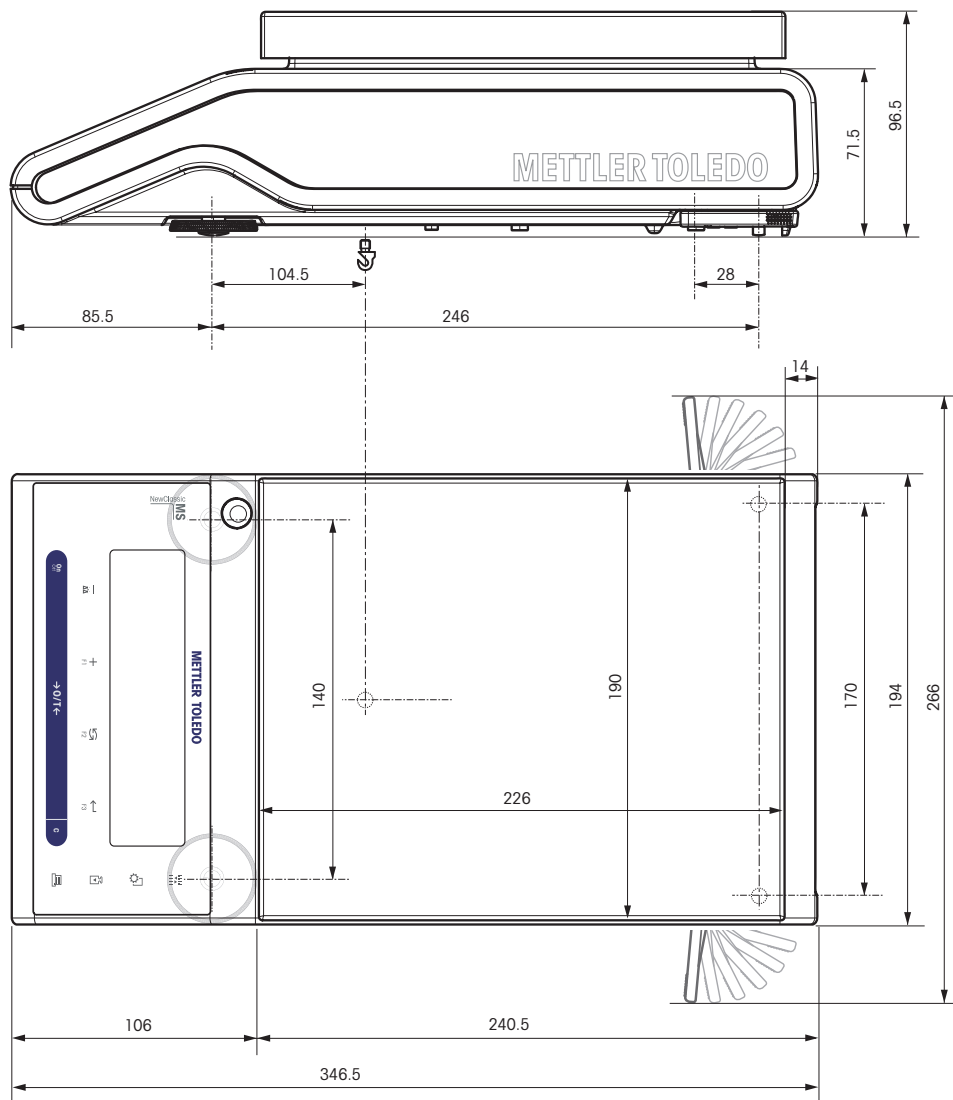



### 20.3.5 Balances with Readability of 0.1 g to 5 g, L Platform

**Models:**

- MS12001L
- MS16001L
- MS16001LE
- MS32001L
- MS32001LE
- MS30000LE
- MS32000LE
- MS15KLE
- MS15KLIPE
- MS24KLIPE
- MS30KLE

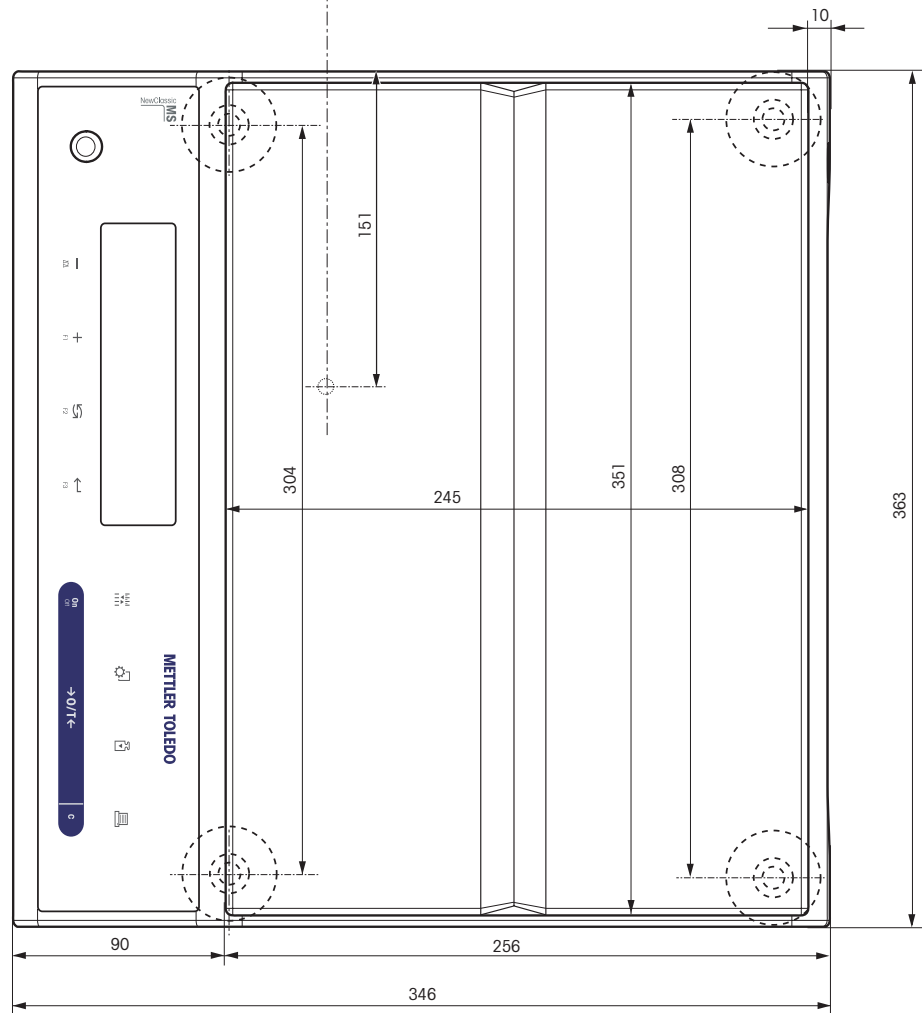
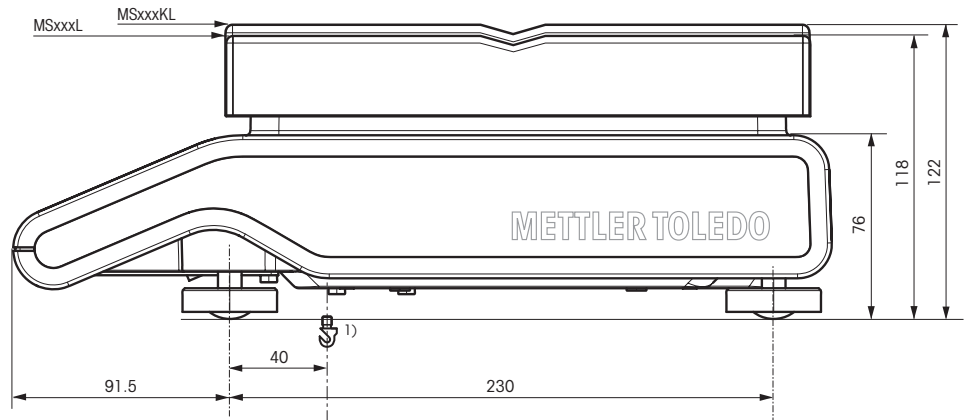

## 21 Accessories and Spare Parts

### 21.1 Accessories

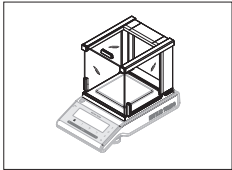
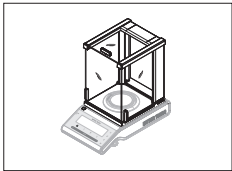
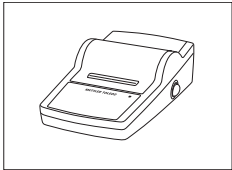
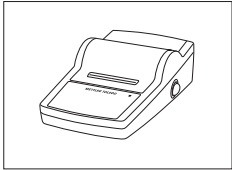
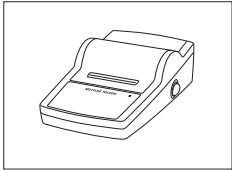
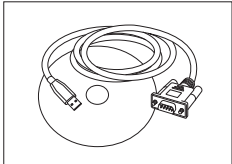
	Description	Part No.
<b>Draft Shields</b>		
	Draft shield with sliding doors "mg" (165 mm)	12122405
	Draft shield with sliding doors "0.1 mg" (237 mm)	12122404
<b>Printers</b>		
	RS-P25 printer with RS232C connection to balance	11124300
	RS-P26 printer with RS232C connection to balance (with date and time)	11124303
	RS-P28 printer with RS232C connection to balance (with date, time and applications)	11124304
<b>Cables for RS232C Interface</b>		
	RS232 - USB converter – intelligent expansion module for connection to PC	11103691

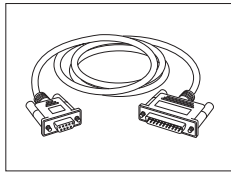

RS9 – RS25 (m/f): connection cable for PC, length = 2 m

11101052

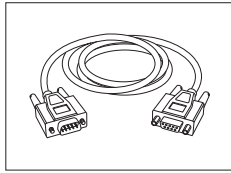

RS9 – RS9 (m/m): connection cable for devices with DB9 (f) socket, length = 1 m

21250066

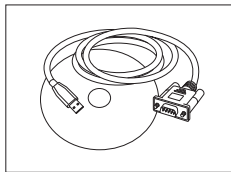

RS232 - USB converter – intelligent expansion module for connection to PC

11103691

**Auxiliary Displays**

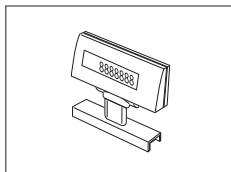

LC/RS-BLD auxiliary display on bench stand with backlit (incl. RS cable and separate AC adapter)

00224200

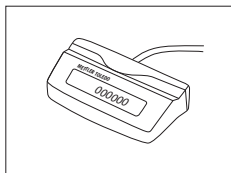

RS232 auxiliary display

12120057

**AC Adapters**

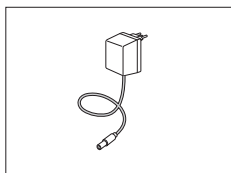

AC adapter universal (EU, USA, AU, UK) 100–240 VAC, 50/60HZ, 0.3 A, 12 V 0.84 A

11120270

**Protective Covers**

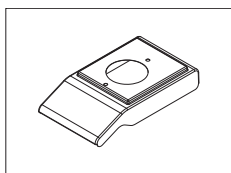

Protective cover for models MS-S with draft shield

12121850

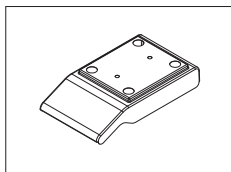

Protective cover for models MS-S without draft shield

12121851

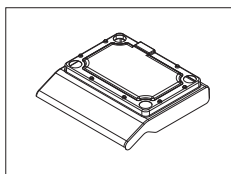

Protective cover for models MS-L up to "1 g"

12121852

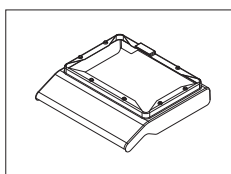

Protective cover for models MS-L "2-5 g"

12121853

### Anti-theft Devices

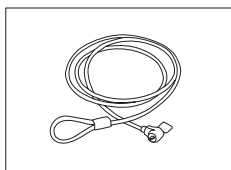

Steel cable

11600361

### Software

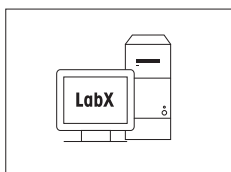

LabX direct balance (simple data transfer)

11101052

### Weighing Below the Balance

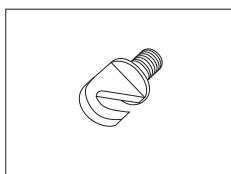

Hook for Platform L

11132565

### Transport Cases

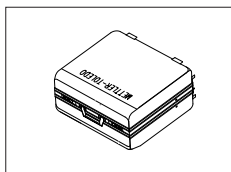

Transport case for S platform balances

11124245

### Adjustment Weights



OIML / ASTM Weights (with calibration certificate) see [www.mt.com/weights](http://www.mt.com/weights)

## 21.2 Spare Parts

### Draft Shield

Drawing	Pos	Description	Part No.	
	5	Draft shield lock	12122013	
	6	Bottom plate	12122019	
	<b>Draft Shield "165 mm"</b>			
	1	Top glass with handle	12121884	
	2	Rear glass low	12122015	
	3	Side glass door left low with handle	12121881	
	4	Side glass door right with handle	12121883	
	5	Front glass low	12122014	
	<b>Draft Shield "237 mm"</b>			
	1	Top glass with handle	12121884	
	2	Rear glass high	12122012	
	3	Side glass door left high with handle	12121880	
	4	Side glass door right high with handle	12121882	
	5	Front glass high	12122011	

**Weighing Pans / Draft Shield Elements / Support**

Drawing	Pos	Description	Part No.	
	<b>For S platform</b>			
	1	0.1 mg	Weighing pan Ø 90 mm	12122010
	2	0.1 mg	Pan support	12122007
	3	0.1 mg	Draft shield element	12122008
	4	1 mg	Weighing pan 127x127 mm	12122009
	5	1 mg	Pan support for models up to 999 g	12122017
	5	1 mg	Pan support for models from 1000 g	12122016
	6	10 mg	Draft shield element	12122018
	7	10 mg	Weighing pan 170x200 mm	12122003
	7	0.1 g	Weighing pan 190x226 mm	12122004
	8	from 10 mg	Pan support caps	12122005
	9	Leveling foot		12122002
	<b>For L platform</b>			
10	Weighing pan 246x352 mm		12122020	
11	to 1 g	Pan support caps	12122001	
12	from 2 g	Pan support caps	12122006	
13	Leveling foot		12122000	

## 22 Appendix

### 22.1 Conversion Table for Weight Units

Kilogram	1 kg	=	1000.0	g	1 g	=	0.001	kg
Milligram	1 mg	=	0.001	g	1 g	=	1000.0	mg
Microgram	1 µg	=	0.000001	g	1 g	=	1000000.0	µg
Carat	1 ct	=	0.2	g	1 g	=	5.0	ct
Pound	1 lb	=	453.59237	g	1 g	≈	0.00220462262184878	lb
Ounce (avdp)	1 oz	=	28.349523125	g	1 g	≈	0.0352739619495804	oz
Ounce (troy)	1 ozt	=	31.1034768	g	1 g	≈	0.0321507465686280	ozt
Grain	1 GN	=	0.06479891	g	1 g	≈	15.4323583529414	GN
Pennyweight	1 dwt	=	1.55517384	g	1 g	≈	0.643014931372560	dwt
Momme	1 mom	=	3.75	g	1 g	≈	0.266666666666667	mom
Mesghal	1 msg	≈	4.6083	g	1 g	≈	0.217	msg
Tael Hong Kong	1 tlh	=	37.429	g	1 g	≈	0.0267172513291833	tlh
Tael Singapore (Malaysia)	1 tfs	≈	37.7993641666667	g	1 g	≈	0.0264554714621853	tfs
Tael Taiwan	1 tft	=	37.5	g	1 g	≈	0.0266666666666667	tft
Tola	1 tola	=	11.6638038	g	1 g	≈	0.0857353241830079	tola
Baht	1 baht	=	15.16	g	1 g	≈	0.0659630606860158	baht

---

## 23 Index

---

### A

Accessories	90
Adjustment	20, 31, 32
Advanced menu	27
Advanced Menu	31
Ambient conditions	17
Appendix	95
Application "Check Weighing"	45
Application "Diagnostics"	37, 60
Application "Dynamic Weighing"	53
Application "Formulation"	49
Application "Multiplication Factor Weighing"	55
Application "Percent Weighing"	43
Application "Piece Counting"	41
Application "Routine Test"	57
Application "Statistics"	47
Application "Totaling"	51
Application "Weighing"	23
Application icons	12
Assign Application	36, 36, 36
Automatic adjustment	20
Automatic shutoff	34
Automatic zero setting	35
Autozero	35

---

### B

Backlight	34
Balance history	63
Balance information	65
Basic menu	27, 30
Battery operation	19
Baudrate	38
Beep	31, 34, 34
Bit/Parity	38

---

### C

Calibration	20, 31
Calibration history	64
Cancel	29
Change settings	29, 29
Char Set	39, 39
Check Weighing	45
Cleaning	69, 69
Closing the menu	29
Control Limit	59

---



---

Conventions and symbols	7
Conversion table for weight units	95

---

<b>D</b>	
Date	30, 32
Date format	32
Delivery inspection	14
DeltaRange balances	25
Diagnose	37
Diagnostics	60
Diagnostics application	37
Dimensions	85
Display	35
Display panel	12
Display test	61
Disposal	8
Draft Shield	15, 69, 93
Dynamic Weighing	53

---

<b>E</b>	
End of Line	38, 39
Environment	31
Error messages	67
External weight	21

---

<b>F</b>	
FACT	20, 32, 32
Factor Weighing	55
Formulation	49
Fully automatic adjustment	20, 32

---

<b>G</b>	
Good Weighing Practice	57
GWP	57, 59

---

<b>H</b>	
Handshake	38

---

<b>I</b>	
Icons	12
Input principle	29
Installing the components	15
Interface menu	28, 37
Interface MT-SICS commands and functions	73
Interface RS232C	37, 72
Interface USB device	39, 72
Internal weight	21
Interval	40
Introduction	7

---

**K**

Key assign	36, 36, 36
Key beep	31, 34
Key functions	11
Key test	61

**L**

L platform overview	10
Language	35
Leveling the balance	17
Location	17

**M**

Manual adjustment with external weight	21
Manual adjustment with internal weight	21
Menu	27
Menu Advanced	27, 31
Menu Basic	27, 30
Menu Interface	28, 37
Menu mode	28, 30
Menu operation	28
Menu topic	28, 29, 29
Motor test	62
MT-SICS interface commands and functions	73
Multiplication Factor Weighing	55

**N**

Net	24
Numerical values	29

**O**

Opening the menu	28
Operation keys	11
Overview	9

**P**

Percent Weighing	43
Performing a simple weighing	24
Piece Counting	41
Power supply	18
Print	26
Protocol trigger	32

**Q**

Quickstart	23, 34
------------	--------

**R**

Recall	25, 33
Repeatability test	60

Reset	31, 37
Routine Test	57
RS232C interface	37, 72

**S**

S platform overview	9
Safety precautions	8
Saving settings	29
Select menu topic	28
Selecting the location	17
Service	35, 69
Service icon	35
Service provider information	66
Service reminder	35
Set menu mode	28
Setting up the balance	14
Shutoff	23, 34
SOP	59
Spare parts	93
Stability beep	34
Startup	23, 34
Statistics	47
Status icons	12
Status messages	67
Submenu	29
Switching the balance on and off	23
Switching weight units	25
Symbols and conventions	7

**T**

Taring	24
Technical data dimensions	85
Technical data general	76
Technical data model-specific	77
Time	30, 32
Time format	33
Topic	28, 29, 29
Totaling	51
Transmit data	26
Transporting the balance	19

**U**

Unit	30, 31, 33, 33
Unpacking	14
USB device interface	39, 72

**W**

Warning Limit	59
---------------	----

## Index

---

Weighing below the balance	19
Weighing made simple	23
Weighing-in aid	26
Weight unit	25, 30, 31, 33, 33, 95

---

### **Z**

Zero range	35
Zeroing	24, 35



**To protect your METTLER TOLEDO  
product's future:**

METTLER TOLEDO Service assures the  
quality, measuring accuracy and preservation  
of value of all METTLER TOLEDO  
products for years to come.

Please send for full details about our  
attractive terms of service.

Thank you.



\* 1 1 7 8 1 2 5 9 \*

[www.mt.com/newclassic](http://www.mt.com/newclassic)

For more information

**Mettler-Toledo AG**

Laboratory & Weighing Technologies  
CH-8606 Greifensee, Switzerland

Subject to technical changes  
© Mettler-Toledo AG 2009  
11781259 0309/2.12

**GWP®**

Good Weighing Practice™

The global weighing guideline GWP® reduces risks  
associated with your weighing processes and helps to

- choose the appropriate balance
- reduce costs by optimizing testing procedures
- comply with the most common regulatory requirements

► [www.mt.com/GWP](http://www.mt.com/GWP)