

GE Healthcare

Control Units CU-950 and CU-960

Instructions



Important user information

All users must read this instruction to fully understand the safe use of the CU-950 and CU-960 control units.

Safety notices

This manual contains warnings and cautions concerning the safe use of the product. See definitions below.



WARNING! The WARNING symbol and notice highlight instructions that must be followed to avoid personal injury. Do not proceed until all stated conditions are clearly understood and met.

CAUTION! The CAUTION notice highlights instructions that must be followed to avoid damage to the product or other equipment. Do not proceed until all stated conditions are met and clearly understood.

Note: A Note is used to indicate information that is important for trouble-free and optimal use of the product.

Recycling



This symbol indicates that the waste of electrical and electronic equipment must not be disposed as unsorted municipal waste and must be collected separately. Please contact an authorized representative of the manufacturer for information concerning the decommissioning of equipment.



WARNING! All repairs should be done by personnel authorized by GE Healthcare. Do not open any covers or replace parts unless specifically stated in the instructions.

Declaration of conformity

This product meets the requirements of applicable CE-directives. A copy of the corresponding Declaration of Conformity is available on request.

The **CE** symbol and corresponding Declaration of Conformity is valid for the instrument when it is:

- used as a stand-alone unit, or
- connected to other CE-marked GE Healthcare instruments, or
- connected to other products recommended or described in this instruction, and
- used in the same state as it was delivered from GE Healthcare, except for alterations described in this instruction.

Note: *The Declaration of conformity is valid only for instruments that are marked with the CE logo.*



Contents

1	Introduction	6
2	Description	7
	2.1 Front panel LEDs	8
	2.2 Back panel	8
3	CU-950 only: Installation on ÄKTAexplorer and ÄKTApurifier	9
4	CU-950 only: Installation on ÄKTAFLC	11
5	CU-950 only: Installation on ÄKTApilot	13
6	CU-960 only: Installation on ÄKTAprocess	14
7	Flash memory card	15
8	Error messages from CU-950/960 displayed in UNICORN	16
9	CU-960 only: Installation on ÄKTAready	20

Control Units CU-950 and CU-960

1 Introduction

The Control Units CU-950 and CU-960 are used as the controlling interface between a UNICORN™ workstation and the components of an ÄKTA™ system.

CU-950

This instruction describes CU-950 and provides information on how to install this control unit with ÄKTAexplorer™, ÄKTApurifier™, ÄKTAFPLC™, and ÄKTApilot™.

CU-960

CU-960 is the standard control unit delivered with ÄKTAprocess™ and ÄKTAreedy™ systems.

2 Description

CU-950

CU-950 unit consists of a back panel with connectors and three indicator lamps (LEDs) on the front. The unit is supplied with a small power converter and EU and US mains cables. It is connected to a UNICORN workstation using the:

- USB port. The CU-950 USB is designed as a convenient solution for users running a single systems from one laptop computer. The CU-950 USB is connected via the USB interface and each UNICORN workstation can use one CU-950 USB to control one system.
- Ethernet interface, so called Advance mode. The CU-950 Advanced mode is designed for users that expect robustness in, for example, manufacturing. The CU-950 Advanced mode is connected to the UNICORN workstation via an Ethernet network interface and operates from a designated IP address. Up to four CU-950 can be connected enabling simultaneous control of four systems. The CU-950 Advanced mode is offered with an option to use 128 MB internal memory for improved preparedness in case of communication failures between the UNICORN workstation computer and the CU-950.

The control unit is designated its own IP-address and can be connected directly to a network switch or hub instead of a local UNICORN workstation.

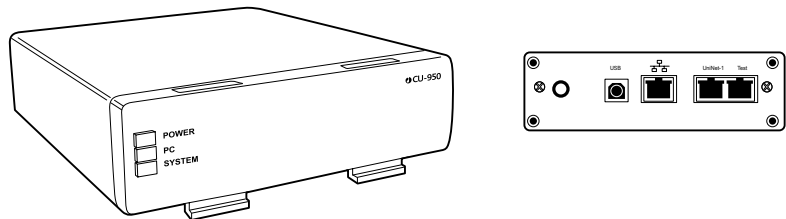

Figure 2-1. CU-950 unit, front and back panel.

CU-960

The CU-960 controller card is self-contained with a separate power supply, independent of the controlling workstation. It is connected to a UNICORN workstation using the Ethernet interface. The control unit is designated its own IP-address and can be connected directly to a network switch or hub instead of a local UNICORN workstation. The CU-960 is equivalent to the CU-950 Advanced mode with the memory option. The CU-960 has communication support for Profibus components and is used in the ÄKTApocess systems and other process systems.



Figure 2-2. CU-960 unit, front and back panel.

Note: The USB interface is only used by GE Healthcare service personnel for service purposes.

2.1 Front panel LEDs

The functions of the three green LEDs on the front panel labelled **Power**, **PC** and **System** are described below:

LED	FLASHING	ON
Power	Internal test running or not OK	Power on, internal test OK
PC	No PC communication	Contact with PC OK
System	No system communication	System communication OK

When the system LED flashes the System Control Run Data Instruments shows **Scanning**, the cause can be seen from the table below:

No communication to:	Approximate flash time
ÄKTA system	0.5 s
Profibus system	2 s
ÄKTA and Profibus systems	1 s

When the system LED is **On**, the System Control Run Data Instruments shows **Ready**, if there where any instrument modules with error or that an instrument module is missing. The error will be reported in system control before the "Instruments" Run Data changes from **Scanning** to **Ready**.

2.2 Back panel

The back panel ports are (from left to right):

- Power supply input
- **CU-960 only:** Profibus port – for system communication
- USB port – for network/controlling workstation communication (UNICORN)
– CU-960: for service use only
- Ethernet port – for network/controlling workstation communication (UNICORN)
- UniNet-1 port – for system communication
- Test port – for service use only

CAUTION! Ensure that the CU-960 is connected to the proper power supply, 12-24 VDC 1A.

3 CU-950 only: Installation on ÄKTAexplorer and ÄKTApurifier

- 1 Hang the CU-950 on the left side of the system by inserting the hooks on the front of CU-950 into the channel on the side of the UV-900 and rotating into position, as shown in the illustration below. ÄKTApurifier system is shown as an example.

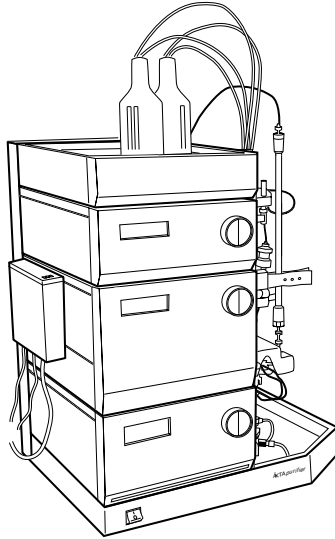

Figure 3-1. Location of CU-950 on ÄKTApurifier system.

Figures 3-2 and 3-3 show the schematic CU-950 cable connections for ÄKTAexplorer, and ÄKTApurifier respectively. Remember that the CU-950 unit is actually mounted on the side of UV-900.

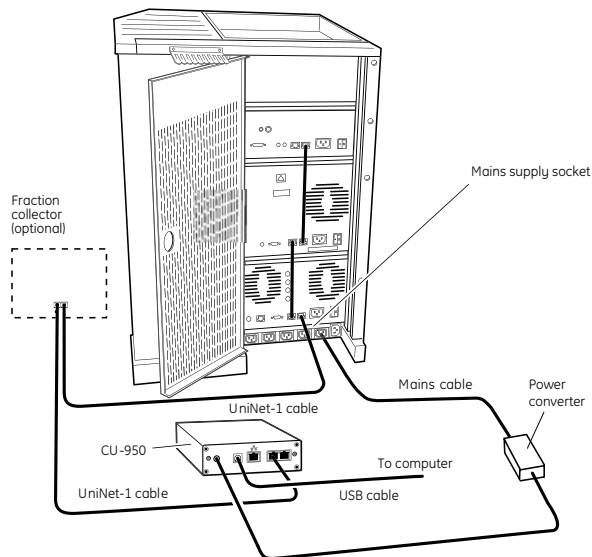

Figure 3-2. Schematic UniNet-1 and mains cable connections for ÄKTAexplorer.

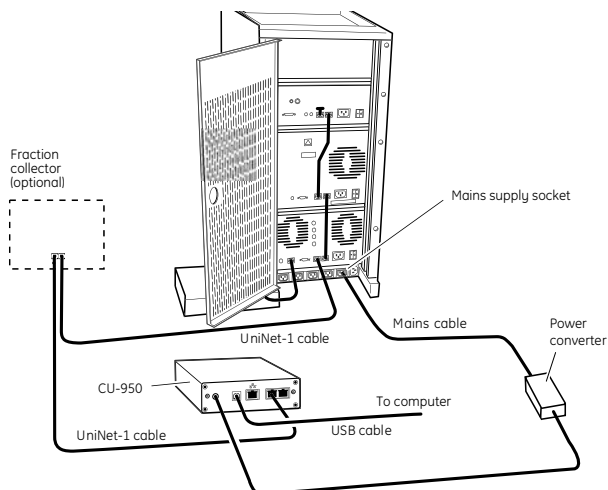

Figure 3-3. Schematic UniNet-1 and mains cable connections for ÄKTApurifier.

How to connect the cables:

- 1 Connect the UniNet-1 data communication cable between the UniNet-1 port on CU-950 and Pump P-900 in the system.



WARNING! Only use mains cables delivered and approved by GE Healthcare.

Note: If a fraction collector is used, connect the fraction collector UniNet-1 cable between Pump P-900 and the fraction collector, and the 1.5 m UniNet-1 cable between the fraction collector and CU-950, and then the USB cable between CU-950 and the computer.

- 2 Connect the power converter cable to the Input port on CU-950.
- 3 Connect the mains cable between the power converter and the mains supply socket at the rear of the system.
- 4 If an auto-sampler is used, the mains cable to the autosampler may be connected to an external mains outlet if all mains supply sockets on the system are occupied.

Note: In this case the autosampler must be manually reset by disconnecting the power cable when performing a system reset or restart.

- 5 Connect the USB cable to the USB port on CU-950. For connection to and installation on the computer, please refer to the UNICORN Administration and technical manual.

4 CU-950 only: Installation on ÄKTAFPLC

- 1 Hang the CU-950 on the left side of the system by inserting the hooks on the front of CU-950 into the channel on the side of the UPC-900 and rotating into position, as shown below.

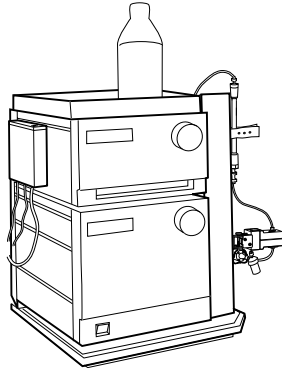

Figure 4-1. Location of CU-950 on ÄKTAFPLC.

Fig. 4-2 shows the schematic CU-950 cable connections for ÄKTAFPLC. Remember that the CU-950 unit is actually mounted on the side of UPC-900.

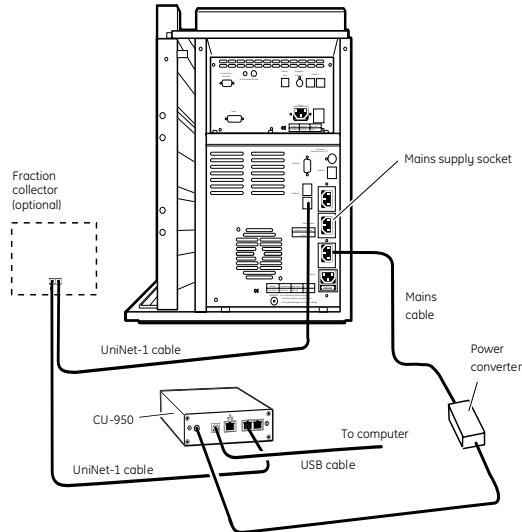

Figure 4-2. Schematic UniNet-1 and mains cable connections for ÄKTAFPLC.

How to connect the cables:

- 1 Connect the UniNet-1 data communication cable between the UniNet-1 port on CU-950 and Pump P-920 in the system.

Note: *If a fraction collector is used, connect the fraction collector UniNet-1 cable between P-920 and the fraction collector, and the 1.5 m UniNet-1 cable between the fraction collector and CU-950, and then the USB cable between CU-950 and the computer.*

- 2 Connect the cable on the CU-950 power converter to the Input port on CU-950.
- 3 Connect the mains cable between the power converter and the mains supply socket at the rear of the system.
- 4 If an autosampler is used, the mains cable to the autosampler may be connected to an external mains outlet if all mains supply sockets on the system are occupied.

Note: *In this case the autosampler must be manually reset by disconnecting the power cable when performing a system reset or restart.*

- 5 Connect the USB cable to the USB port on CU-950. For connection to and installation on the computer, please refer to the UNICORN Administration and technical manual.

5 CU-950 only: Installation on ÄKTApilot

ÄKTApilot uses a CU-950 Advanced, with a 128 MB flash memory card.

The CU-950 unit and the power converter is placed near or inside ÄKTApilot.

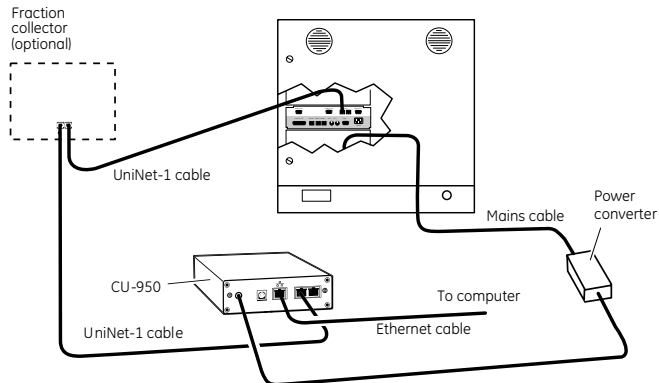

Figure 5-1. Schematic UniNet-1 and mains cable connections for ÄKTApilot.

How to connect the cables:

- 1 Connect the UniNet-1 data communication cable between the UniNet-1 port on CU-950 and one of the UniNet-1 sockets on the controller rear panel inside ÄKTApilot.

Note: If a fraction collector is used, connect the fraction collector UniNet-1 cable between the controller rear panel inside ÄKTApilot and the fraction collector, and the 1.5 m UniNet-1 cable between the fraction collector and CU-950.

- 2 Connect the cable on the CU-950 power converter to the Input port on CU-950.
- 3 Connect the mains cable between the power converter and the mains supply socket inside the system.
- 4 Connect the Ethernet cable to the Ethernet port on CU-950. For connection to and installation on the computer, please refer to the UNICORN Administration and technical manual.

6 CU-960 only: Installation on ÄKTAprocess

The CU-960 is delivered pre-installed in all ÄKTAprocess systems. All necessary connections are made and tested already when the system is assembled before delivery. The unit is mounted in a rack adaptor which is mounted in the instrument rack inside the electronics cabinet of the ÄKTAprocess system, as illustrated below.

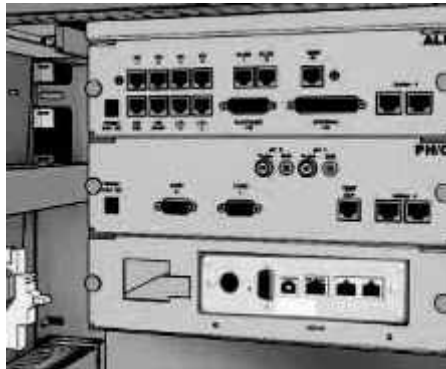

Figure 6-1. CU-960 mounted in an ÄKTAprocess system.

Note: *When the CU-960 is mounted in the system cabinet the indicator LEDs may not be visible since the front of the unit is facing inwards.*



WARNING! Only personnel authorized by GE Healthcare are allowed to open the electronics cabinet of the ÄKTAprocess systems.

7 Flash memory card

The CU-960* is delivered with a 128 MB flash memory card which, depending on the UNICORN system settings, can buffer run data when the control unit is in operation, in the event of a computer failure, broken communication between the unit and workstation or a power failure. The run may proceed and data may be stored in the CU-960* flash memory until communication between the workstation and the CU-960* is re-established or the workstation is functional again. The run will continue only until the flash memory is full.

Run data is saved at intervals by UNICORN. If a power failure occurs immediately before UNICORN has saved the run data several minutes of data may be lost. However, if selected in UNICORN, run data is saved continuously on the flash memory card and the data will be saved up to the time when the CU-960* lost its power. When power is restored, the run data may be retrieved.

* The CU-950 can also be equipped with a flash memory card and be configured for Advanced mode.

8 Error messages from CU-950/960 displayed in UNICORN

Error Id no.	Error message	Cause	Suggested Action
Error codes for Controller card			
1001	List does not start with \$	Internal error.	Create a report.
1002	Download not for this system	Internal error.	Create a report.
1003	Unknown list prefix	Internal error.	Create a report.
1004	M/S table index out of range	Internal error.	Create a report.
1005	BASE variable not valid	Internal error.	Create a report.
1006	Missing numeric character	Internal error.	Create a report.
1007	Wrong parameter type	Internal error.	Create a report.
1008	No decimal point in real	Internal error.	Create a report.
1009	Value table index out of range	Internal error.	Create a report.
1010	No 'V' when expected	Internal error.	Create a report.
1011	No type on value	Internal error.	Create a report.
1013	Missing parameters	Internal error.	Create a report.
1014	Error in local value	Internal error.	Create a report.
1015	Unknown opcode	Internal error.	Create a report.
1016	Erroneous real format	Internal error.	Create a report.
1017	System not in IDLE	Internal error.	Create a report.
1018	See Help	Internal error.	Create a report.
1019	No < 1 or > UCO_MAX_COMMANDS	Internal error.	Create a report.
1020	No of param>UCO_MAX_PARAMETERS	Internal error.	Create a report.
1021	Error in terminal field	Internal error.	Create a report.
1023	0 or 1 expected, not received	Internal error.	Create a report.

Error Id no.	Error message	Cause	Suggested Action
# Method Executor error codes			
1030	Missing at least one list	Internal error.	Create a report.
1031	System is already running	Internal error.	Create a report.
1032	Erroneous parameter	Internal error.	Create a report.
1033	Unknown opcode	Internal error.	Create a report.
1034	Erroneous value for value table	Internal error.	Create a report.
1035	Unexpected end of list	Internal error.	Create a report.
1036	Call and/or loop nest too deep	Internal error.	Create a report.
1037	Missing value table index	Internal error.	Create a report.
1038	Unknown list type	Internal error.	Create a report.
1039	Missing method event list	Internal error.	Create a report.
1040	Erroneous condition id	Internal error.	Create a report.
1041	Missing submethod list	Internal error.	Create a report.
1042	Too many parameters in instrument	Internal error.	Create a report.
1043	M/S table index out of range	Internal error.	Create a report.
1044	Internal	Internal error.	Create a report.
1045	Value table index out of range	Internal error.	Create a report.
1046	Method error, system stopped	Internal error.	Create a report.
1047	Wrong value type in write_vt	Internal error.	Create a report.
1060	Unknown opcode in manual command	Internal error.	Create a report.
1061	Wrong number of pars in command	Internal error.	Create a report.
1070	> 16 data sel blocks active	Internal error.	Create a report.
1071	VRTXsaTM queue error	Internal error.	Create a report.

Error Id no.	Error message	Cause	Suggested Action
1100	Error in strategy execution	Internal error.	Create a report.
1101	Undef. strat block,	The strategy contains an unknown block	Upgrade UNICORN software or reinstall old strategy
1700	>95% CPU Load	Internal error.	Create a report.
# SAP error codes			
1303	Tuning forbidden in this state	Internal error.	Create a report.
1305	Wrong test type in strat. block	Internal error.	Create a report.
1308	Wrong parameter type in strat.	Internal error.	Create a report.
1309	Parvalue out of range in strat	Internal error.	Create a report.
1310	Missing par in strategy block	Internal error.	Create a report.
1311	Wrong index in strat. RUNMODE	Internal error.	Create a report.
1312	Strategy contains unknown block	Internal error.	Create a report.
1315	Trm index out of range, RUNMODE	Internal error.	Create a report.
2000	UniNet controller is restarted	The UniNet controller is restarted - messages are lost.	Check instrument connection.
2001	WARNING - faulty UniNet comm.	Faulty UniNet communication - no message lost.	Check instrument connection.
2002	UniNet controller overrun	Messages are lost.	Check instrument connection.
2003	UniNet pkg rec in wrong order	UniNet package received in wrong order.	Make sure that all connected valves have a unique id. Number.
2010	Too many pars	Internal error.	Create a report.
2011	Undef service	Internal error.	Create a report.
2012	No response	System could not find specific unit.	Check instrument connection. If Error message appears during system start up and specific unit is not included in the system configuration this message can be ignored.

Error Id no.	Error message	Cause	Suggested Action
2013	Incorrect reply from instrum.	Internal error.	Create a report.
2014	No pars in comm	Internal error.	Create a report.
2021	No instrument is responding	Internal error.	Create a report.
2022	No instrms defined in strategy	Internal error.	Create a report.
2023	No relay unit def	Internal error.	Create a report.
2024	Too many instrms def in strat.	Internal error.	Create a report.
19	See Help	Internal error.	Create a report.
38	See Help	Internal error.	Create a report.
51	Unable to allocate CAN c block	Internal error.	Create a report.
52	Unable to post CAN cmd block	Internal error.	Create a report.
53	Unable to allocate CAN m block	Internal error.	Create a report.
54	Unable to post CAN msg block	Internal error.	Create a report.
55	General CAN driver error	Internal error.	Create a report.
3000	Storing index hit max	CU-960 will no longer be able to recover data in case of communication loss	Create a report.
3001	Fatal Strategy Error	Strategy uses Profibus card, card not in CU configuration.	Please create a report and contact service

9 CU-960 only: Installation on ÄKTAready

Connection from the system computer to the internal control unit CU-960 is made by the water proof RJ45 connector placed in the bottom of the main cabinet (VS-08-A-RJ45/MOD-1-IP67 + VS-08-BU-RJ45-5-F/BU). It is absolutely necessary from an EMC perspective to connect this connector shielding to the cabinet using either copper tape or the small sheet-metal shroud developed in the project.

The mating connector cable assembly needs to have the matching water proof plug type provided by Phoenix. (VS-08-RJ45-5-Q/IP67) to maintain IP67. Suitable mating cable assembly is described in assembly drawing 14001358 (part number 28-4022-13) and is supplied with the system in the accessory-kit.

Note: *The internal LAN cable is a cross-over type!*

If the system is connected to a switch/hub, a cross-over cable must be connected in series with a cable provided by GE Healthcare, part number 28-4022-13.

For local office contact information, visit

www.gelifesciences.com/contact

GE Healthcare Bio-Sciences AB
Björkgatan 30
751 84 Uppsala
Sweden

www.gelifesciences.com/protein-purification-bioprocess

www.gelifesciences.com/akta

GE, imagination at work and GE monogram are trademarks of General Electric Company.

ÄKTA, ÄKTAexplorer, ÄKTAFLC, ÄKTApilot, ÄKTAprocess, ÄKTApurifier, ÄKTAready, Drop Design, and UNICORN are trademarks of GE Healthcare companies.

UNICORN: Any use of this software is subject to GE Healthcare Standard Software End-User License Agreement for Life Sciences Software Products.

All third party trademarks are the property of their respective owners.

© 2009 General Electric Company—All rights reserved.
First published Jan. 2009

All goods and services are sold subject to the terms and conditions of sale of the company within GE Healthcare which supplies them. A copy of these terms and conditions is available on request. Contact your local GE Healthcare representative for the most current information.

GE Healthcare UK Ltd
Amersham Place, Little Chalfont,
Buckinghamshire, HP7 9NA,
UK

GE Healthcare Bio-Sciences Corp
800 Centennial Avenue,
P.O. Box 1327, Piscataway,
NJ 08855-1327,
USA

GE Healthcare Europe GmbH
Munzinger Strasse 5,
D-79111 Freiburg,
Germany

GE Healthcare Bio-Sciences KK
Sanken Bldg. 3-25-1,
Hyakunincho, Shinjuku-ku,
Tokyo 169-0073,
Japan



imagination at work