

This manual covers the model shown below

NA Model	EU Model	Voltage	Description
88861025	N/A	100~240V	Open Air Rocker US
88861026	15514070	100~240V	Open Air Rocker Intl



Before using this product, read this entire operation manual carefully. Users should follow all of the operational guidelines contained in this manual and take all necessary safety precautions while using this product. Failure to follow these guidelines could result in potentially irreparable bodily harm and/or property damage.

Caution all internal adjustments and maintenance must be performed by qualified service personnel.

Material in this manual is for information purposes only. Fisher Scientific is committed to a continuing program of product development and improvement, and reserves the right to change information, such as specifications, appearance, and dimensions, described in this document without notice. Fisher Scientific makes no representations or warranties with respect to this manual. In no event shall Fisher Scientific be held liable for any damages, direct or incidental, arising out of or related to the use of this manual.

No part of this manual may be reproduced or transmitted in any form or by any means, including photocopying, recording, or using information storage and retrieval systems, for any purpose other than the purchaser's own use, without the express written permission of the manufacturer.

Any other product names and services identified in this manual are trademarks or registered trademarks of their respective owners. No such use, or the use of any trade name, is intended to convey endorsement or other affiliation with Fisher Scientific.

©2017 Fisher Scientific. All rights reserved.

Contents

Section 1 Inspection and Installation	4
Packing List	4
Connections	4
Structure Diagram	4
<hr/>	
Section 2 Overview	5
Specifications	5
Environmental Conditions	5
Safety Instructions	5
Loads, Angle and Speed	6
<hr/>	
Section 3 Operation	7
Control Panel	7
Installation	7
Settings	7
Installation of Two Trays	8
<hr/>	
Section 4 Safety Tips and Maintenance	9
<hr/>	
Section 5 Troubleshooting	10
<hr/>	
Section 6 Optional Accessories/Spare Parts	11
<hr/>	
Section 7 Warranty	12
<hr/>	

Section 1 Inspection and Installation

1. Inspect package and contents upon receipt of the instruments. If the package is severely damaged or if there are any missing pieces, please contact the manufacturer immediately.







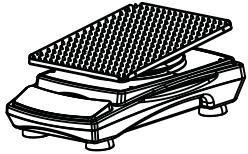
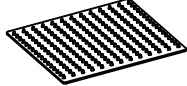

2. Unpack the instrument, ensure all parts of the instrument and accessories are not missing or damaged. Make sure to take out

all the components before discarding the packing. If there are any missing or damaged pieces, please contact the manufacturer immediately.

3. Place the instrument on a level and firm surface to avoid vibration and noise.

1.1 Packing List

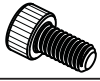
Table -1 Packing List

Description	NA Cat. No.	NA/EU Cat. No.	Figure
Open Air Rocker	88861025 US plug	88861026 /15514070 Intl plug	
*Dimpled Rubber Mat	1	1	
General Power Adaptor	1	1	
US Plug	1	N/A	
CN Plug	N/A	1	
EU Plug	N/A	1	
UK Plug	N/A	1	
*Screw for Rubber Strip	10	10	
Rubber Strip	6	6	

*Has been installed on the instrument

1.2 Connections

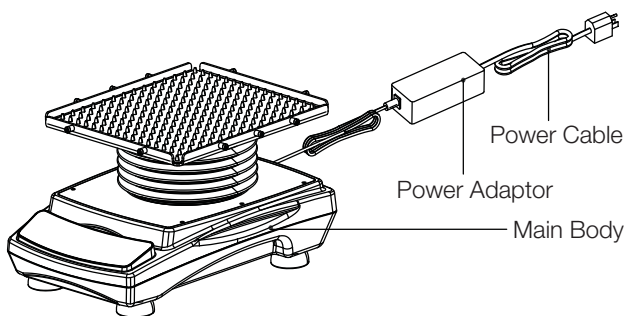

1.3 Structure Diagram

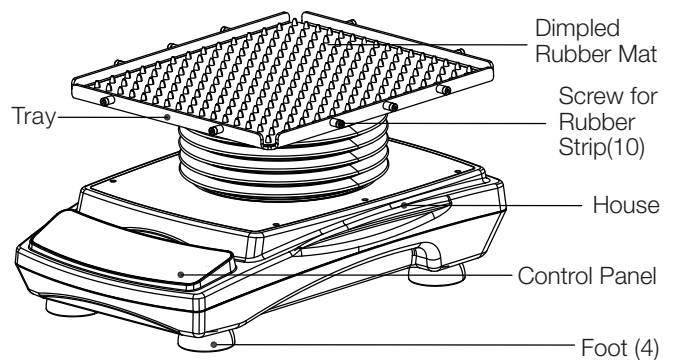

Section 2 Overview

2.1 Specifications

Category Number

Description	NA Cat. No.	NA/EU Cat. No.
Open Air Rocker	88861025 US plug	88861026 /15514070 Intl plug

Speed

Range	1 to 50rpm
Speed Accuracy	±1 rpm
Display	LED
Display Accuracy	1 rpm

Note: Maximum speed may vary with heavy or unbalanced loads.

Rocking Angle

Angle Range	1° ~15°
Angle Accuracy	±1°
Display	LED
Display Accuracy	1°
Rocking Mode	Left right reciprocating motion

Load

Maximum Load (Centered on tray)	4.5 kg (Clamps Included)
------------------------------------	--------------------------

Power Supply

Requirement	AC100-240V, 50Hz/60Hz, 0.1A
-------------	-----------------------------

Time

Timing Range	Continuous Mode (Time displayed as 0) 1s to 9999 min
--------------	--

Size

Overall Dimensions	415×293×204mm(16.3×11.5×8.0in.)
Tray Dimensions	316×276×17mm(12.4×10.9×0.7in.)
Packaging Dimensions	536×501×346mm(21.1×19.7×13.6in.)

Weight

Net Weight	12.7Kg(30lb)
Gross Weight	14.7Kg(32.4lb)

Others

Certificate	ROHS, WEEE, cCSAus, CE Mark
-------------	-----------------------------

2.2 Environmental Conditions

Application Environmental Conditions: indoor use

Temperature	5 to 40°C (41 to 104°F)
Humidity	20% to 85%,
Altitude	≤2,000 m
Voltage Fluctuation	± 10% of the nominal voltage

Storage Environmental Conditions

Temperature	0 to 60°C (36 to 124 °F)
Humidity	20% to 90%, non-condensing

2.3 Safety Instructions

Please read the entire instruction manual before operating the Open Air Rocker.



WARNING DO NOT use the Open Air Rocker in a hazardous atmosphere or with hazardous materials for which the unit was not designed. Also, the user should be aware that the protection provided by the equipment may be impaired if accessories used are not provided or recommended by the manufacturer, or are used in a manner not specified by the manufacturer.

CAUTION ! To avoid electrical shock, completely cut off power to the unit by disconnecting the power cord from the unit or unplug from the wall outlet. Disconnect unit from the power supply prior to maintenance and service. Any spills should be removed promptly. Bio hazard spills should be cleaned using approved liquid promptly. Solvent spills are a fire hazard. Stop the unit immediately, and **DO NOT** operate until clean up is complete and vapors have dissipated.

DO NOT immerse the unit for cleaning.

DO NOT operate the unit if it shows signs of electrical or mechanical damage.

Position of Loads

Place the loads in the recommended positions below:

1. Place load at the center of the tray
2. Place loads symmetrically around the center of the tray
3. Make sure to use rubber strips to fasten containers onto the tray

Centered placement



Symmetrical placement

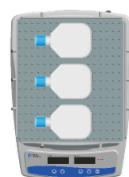
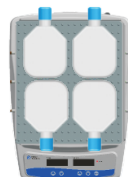

Asymmetrical placement

Cornered placement



Sided placement

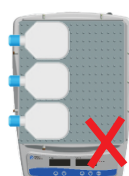
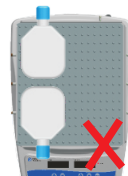

Other placement

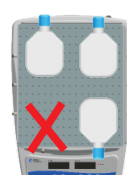

⚠ Asymmetric loading or unloading may affect the normal operation of the instrument and may even cause unpredictable damage.

This Open Air Rocker is applicable to various mixing operations in different areas, including gel colorization/ decolorization, sample cleaning, antibody staining, hybridization, immunoprecipitation, blot, and small volume tissue culture. To avoid accident during operation, please use rubber bands to fasten containers onto the tray.

2.4 Loads, Angle and Speed

Tilt Angle	Placement	Maximum Speed (rpm)	Maximum Weight (Kg)
15°	Centered	50	4.5
1°	Centered	50	4.5
15°	Corner	20	1
1°	Corner	20	1
15°	Sided	30	1.5
1°	Sided	30	1.5

Warning: It may affect the maximum speed of the instrument if placing the cell culture flask in the corner or on one side of the tray. If cornered or sided placement is required by the experiment, please make sure to increase the speed gradually.

Section 3 Operation

This chapter covers the control panel and its operation.

3.1 Control Panel

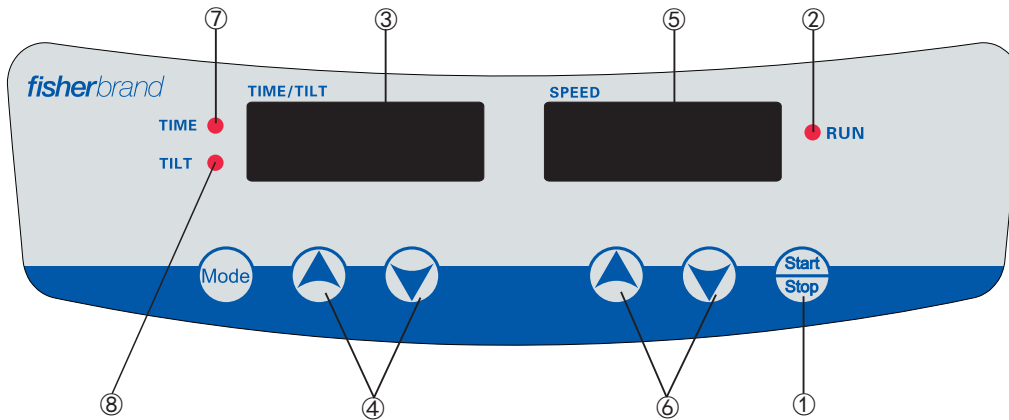

The front panel of the Open Air Rocker contains all the controls needed to operate the unit.

1. Start/Stop button: Start or stop the instrument.
2. RUN indicator light: The light is on when the instrument is running and off when the instrument is in standby.
3. TIME/TILT display window: The window shows cumulative time (in continuous mode) or remaining time (in timer mode). The range of time displayed is 0s to 9999 minutes.
4. Set Time/Tilt buttons: UP/DOWN arrow buttons are used to increase/ decrease the set time/tilt angle of the instrument.
5. SPEED display window: The window shows set speed (when the instrument is in standby) or current speed (when the instrument is running). Speed range is 1 to 50 rpm and the accuracy is 1rpm.
6. Set Speed Buttons: UP/DOWN arrow buttons are used to increase/ decrease the set speed of the instrument.
7. TIME indicator light: The light is on when the instrument is running in Timer Mode.
8. TILT indicator light: The light is on when the instrument is in Tilt Adjustment Mode.

2. Timer mode

Press the “▲” or “▼” arrow button below the TIME display window. When the number shown on the display window starts flashing, press “▲” or “▼” arrow button to increase or decrease the time value. Release the button when the time shown on the display window reaches the set value. The time setting is finished after the number shown on the display window has flashed twice.

Speed Settings

Press the “▲” or “▼” arrow button below the SPEED display window. When the number shown on the display window starts flashing, press “▲” or “▼” arrow button to increase or decrease the speed value. Release the button when the speed shown on the display window reaches the set value. The speed setting is finished after the number shown on the display window has flashed twice.

Note: press the “▲” or “▼” arrow button for a longer time to accelerate the setting.

3.2 Installation

1. Connect all the components according to the figures shown on page 4 of this manual. Use grounded power outlet.
2. Press down the power switch on the back right side of the instrument and put it to the “|” state and then the instrument is in standby.

3.3 Settings

Time Settings

1. Continuous mode

Press the “▲” or “▼” arrow button below the TIME display window. When the number shown on the display window starts flashing, press “▼” arrow button to decrease the time to 00:00 and then release the button. The time setting is finished after the number shown on the display window has flashed twice.

Set Tilt Angle

1. Press “Mode” button and the TILT indicator light will be on.
2. Press the “▲” or “▼” arrow button on the left to choose the tilt needed. The range of tilt displayed on the window is 1 to 15°. After 3 seconds, the LED display window will flash and the instrument will automatically take the value shown as the set tilt.
3. Press “Start/Stop” button and the instrument will start rocking in the left right reciprocating mode with the set tilt.

Set Rocking Time

1. Press “Mode” button and the TIME indicator light on the left will be on.
2. Press the “▲” or “▼” arrow button on the left. The display window on the left will show the time value. When the time shown is between 00:01 to 99:59, the default step of the instrument when changing the time is 1 second. Continue to

press “▲” arrow button and the value 0100 will show on the display window. When the time shown is between 0100 to 9999, the default step is 1 minute. 3 seconds after the rocking time is chosen, the LED display window will flash and the instrument will automatically take the value shown as the set rocking time.

3. Press “Start/Stop” button and the instrument will start working with the time set and the display window will show the remaining time. When the timer goes off, the instrument will stop running and the alarm will sound.

Run and Stop

1. Continuous Mode

Press “Start/Stop” button and the instrument will start running with the specified settings and the RUN indicator light will be on. The TIME display window will show the cumulative time and the SPEED display window will show the current speed. Press “Start/Stop” button again and the instrument will slow down until it stops. The instrument will then be in standby and the two display windows will show the set values.

2. Timer Mode

Press “Start/Stop” button and the instrument will start running with the specified settings and the RUN indicator light will be on. The TIME display window will show the remaining time and the SPEED display window will show the current speed. Press “Start/Stop” button again and the instrument will slow down until it stops. The instrument will then be in standby and the two display windows will show the set values.

Finish Operation

After the operation is finished, press the power switch at the back right side the instrument and put it into the “O” state. Unplug the instrument and store the instrument according to the storage guide.

Alarm Instructions

1. If the actual speed of the instrument exceeds or is lower than the set speed to reach alarm range, alarm will be triggered.
2. After the instrument alarms, LED RUN indicator light will go off, LED SPEED window will show “ERR1”, and the machine will stop running, press any key to put the instrument in standby.
3. After the timer goes off, the buzzer will alarm and the instrument will stop running automatically.

Power Recovery

If the power supply is cut off suddenly while the instrument is in operation, the unit will automatically run at the previously set parameter upon power restoration. The display window will flash. Press any button to stop flashing.

Mechanical Zero Correction

To ensure accurate and quality rocking, the instrument will automatically run mechanical zero correction in the following situations:

1. First operation after the machine is turned on;
2. First operation after the rocking speed is reset;
3. After 8 hours of continuous operation.

3.4 Installation of Two Trays

1. Remove the screw for rubber strip at positions A1 to A4 as shown in the figure 1.
2. Place the two trays on to the cylinders at position A1 to A4 shown in the figure 2.
3. Fasten the screw for rubber strip on the two trays as shown in the figure 3.

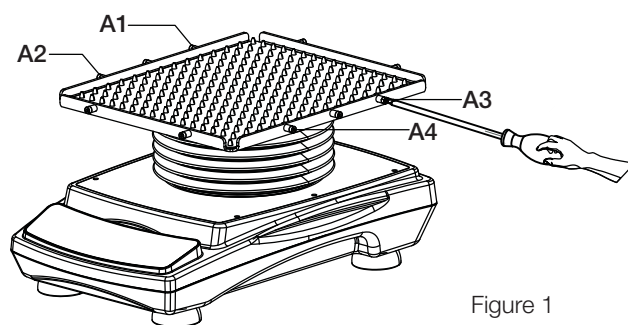

Figure 1

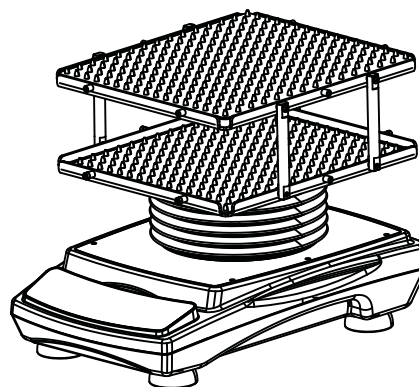

Figure 2

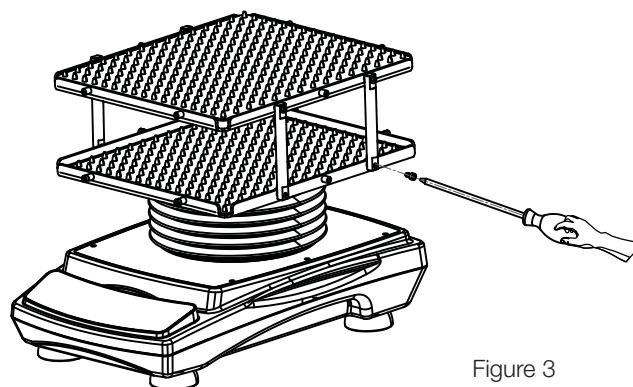

Figure 3

Section 4 Safety Tips and Maintenance

Safety Tips

1. Use independent power supply.
2. Check if the local power supply voltage is suitable for use.
3. Do not drag the power supply cable when unplugging.
4. Do not use non-specified power cable or damage cable.
5. Service should only be performed by a qualified professional.
6. The power supply must be unplugged under the following situations:
 - a. When the unit is moved
 - b. When the electrical cabinet or the moving component is opened
 - c. When the equipment is malfunctioning
 - d. When the equipment is not in use

Maintenance

Instrument case and tray surface can be cleaned with cloth with mild detergent and water.

Surface of the dimpled rubber mat can be cleaned with mild detergent or water and then wiped with clean cloth.

Warning: Avoid dripping detergent or water into the inside of the instrument during cleaning.

Clean Spill

If accidental spillage of liquids caused by mishandling or contained breakage occurs on the surface of the instrument, please shut down the instrument and clean up the liquid immediately.

If the liquid has already spilled into the unit, cut off the power supply first and immediately clean up the liquid at the surface of the instrument. Place the instrument in a ventilated and dry environment for 24 hours before reuse. If the instrument is not functioning after drying for 24 hours, please contact the manufacturer.



Warning: Disassembling/Assembling without a qualified professional's guidance may cause malfunctioning of the instrument.

Section 5 Troubleshooting

Please refer to the following table to troubleshoot if any malfunction occurs. If the problem still exists, contact your local sales representative.

Error	Cause	Solution
Cannot start machine, LED display window off	Power disconnected	Connect the power
	Power switch off	Turn power switch on
	Power adaptor failure	Replace power adaptor
No shaking of the tray	Over-weighted or unbalanced load	Adjust the weight and position of load, decrease rotation speed
	Electrical malfunction	Contact Fisher Scientific
	Mechanical malfunction	Contact Fisher Scientific
Loud noise	Machine case loose	Fasten machine case screws
	Tray loose	Fasten screws
	Machine vibrate	Place instrument at a level and firm surface
Other	Keep record for maintenance	

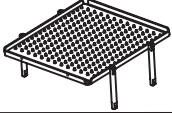
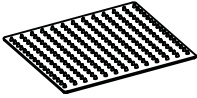
Section 6 Optional Accessories/Spare Parts

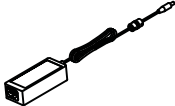
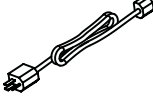
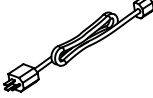
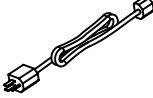
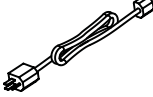
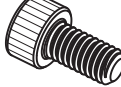
Description	NA Cat. No.	EU Cat. No.	Dimensions	Max. Qty.	Figure
Stacking Tray Assembly	88861197	15584130	306×266×108mm	1	
Dimpled Rubber Mat (Spare Part)	88861198	15594130	298×258mm	1	
Rubber Mat	88861200	15514140	298×258×5mm	1	
Rubber Strips (Spare Part)	88861178	15594120	180×7mm (6pcs/pack)	5	
General Power Adaptor (Spare Part)	88861154	15554120	250VAC, 10A, 1.8m	1	
Power Cable US Plug (Spare Part)	88861155	N/A	250VAC, 16A, 1.8m	1	
Power Cable CN Plug (Spare Part)	88861156	N/A	250VAC, 13A, 1.8m	1	
Power Cable EU Plug (Spare Part)	88861157	15564120	M4×8 (8pcs/pack)	10	
Power Cable UK Plug (Spare Part)	88861158	15574120	306×266×108mm	1	
Screw for Rubber Strip (Spare Part)	88861199	15504140	M4×8 (8pcs/pack)	10	

Section 7 Warranty

When used in laboratory conditions and according to these operation instructions and maintenance, this product is warranted for 24 months against defective materials or workmanship. The 24 month warranty period begins from the delivery date of this product.

For product quality or performance issues, contact Fisher Scientific Customer Service.

North America

United States
1-800-766-7000
fishersci.com

Canada
1-800-234-7437
fishersci.ca

Europe

Austria:
+43(0)800-20 88 40
at.fishersci.com

Belgium:
+32(0)56 260 260
be.fishersci.com

Denmark:
+45 70 27 99 20
fishersci.dk

Germany:
+49(0)180 5258221
de.fishersci.com

Ireland:
+959(0)1 885 5854
ie.fishersci.com

Italy:
+39 02 950 59 478
it.fishersci.com

Finland:
+358(0)9 8027 6280
fishersci.fi

France:
+33(0)388 67 14 14
fishersci.fr

Netherlands:
+31(0)20 4887 70 00
nl.fishersci.com

Norway:
+47 22 95 59 59
fishersci.no

Portugal:
+351 21 425 33 50
pt.fishersci.com

Spain:
+34 002 239 303
es.fishersci.com

Sweden:
+46 31- 68 94 30
fishersci.se

Switzerland:
+41(0)56 618 41 11
ch.fishersci.com

UK:
+44(1)1509 555 500
fisher.co.uk

Find out more at **fishersci.com**