



This manual covers the model shown below

NA Model	EU Model	Voltage	Description
88861023	N/A	100~240V	Microplate Shaker US plug
88861024	15504070	100~240V	Microplate Shaker Intl plug



Before using this product, read this entire operation manual carefully. Users should follow all of the operational guidelines contained in this manual and take all necessary safety precautions while using this product. Failure to follow these guidelines could result in potentially irreparable bodily harm and/or property damage.

Caution all internal adjustments and maintenance must be performed by qualified service personnel.

Material in this manual is for information purposes only. Fisher Scientific is committed to a continuing program of product development and improvement, and reserves the right to change information, such as specifications, appearance, and dimensions, described in this document without notice. Fisher Scientific makes no representations or warranties with respect to this manual. In no event shall Fisher Scientific be held liable for any damages, direct or incidental, arising out of or related to the use of this manual.

No part of this manual may be reproduced or transmitted in any form or by any means, including photocopying, recording, or using information storage and retrieval systems, for any purpose other than the purchaser's own use, without the express written permission of the manufacturer.

Any other product names and services identified in this manual are trademarks or registered trademarks of their respective owners. No such use, or the use of any trade name, is intended to convey endorsement or other affiliation with Fisher Scientific.

©2017 Fisher Scientific. All rights reserved.

Contents

Section 1 Inspection and Installation	4
Packing List	4
Connections	4
Structure Diagram	4
<hr/>	
Section 2 Overview	5
Specifications	5
Environmental Conditions	5
Safety Instructions	5
Capacity and Speed	6
<hr/>	
Section 3 Operation	7
Control Panel	7
Installation	7
Settings	7
Installation of Accessories	8
<hr/>	
Section 4 Safety Tips and Maintenance	9
<hr/>	
Section 5 Troubleshooting	10
<hr/>	
Section 6 Optional Accessories/Spare Parts	11
<hr/>	
Section 7 Warranty	12
<hr/>	

Section 1 Inspection and Installation

1. Inspect package and contents upon receipt of the instruments. If the package is severely damaged or if there are any missing pieces, please contact the manufacturer immediately.







2. Unpack the instrument, ensure all parts of the instrument and accessories are not missing or damaged. Make sure to take out

all the components before discarding the packing. If there are any missing or damaged pieces, please contact the manufacturer immediately.

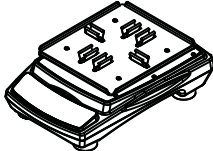
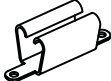
3. Place the instrument on a level and firm surface to avoid vibration and noise.

1.1 Packing List

Table -1 Packing List

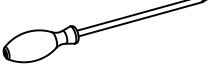
Description	NA Cat. No.	NA/EU Cat. No.	Figure
Microplate Shaker	88861023 US plug	88861024 /15504070 Intl plug	
*96-well microplate holder	6	6	 (Assembly on the platform)
General Power Adaptor	1	1	
US Plug	1	N/A	
CN Plug	N/A	1	
EU Plug	N/A	1	
UK Plug	N/A	1	
*M3x6 Screw	12	12	
Screw Driver	1	1	

*Has been installed on the instrument

1.2 Connections

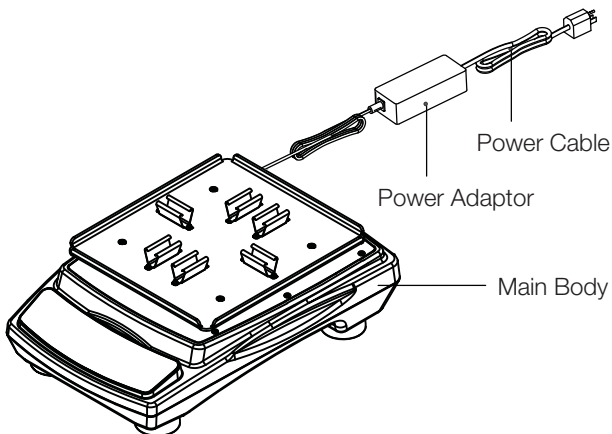

1.3 Structure Diagram

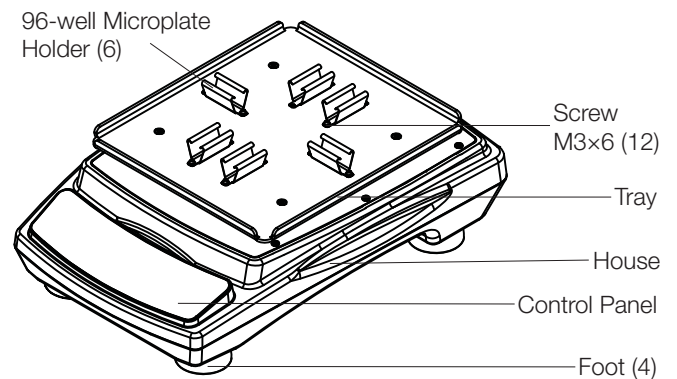

2.4 Capacity and Speed

Load Type	Liquid Capacity	Max Speed
96-well Microplate	1/2-well deep	1000rpm
96-well Microplate	2/3-well deep	800rpm
Fixed Tube Rack 40×Φ14		500rpm
Fixed Tube Rack 40×Φ16		450rpm
Adjustable Tube Rack 40×Φ14		500rpm
Adjustable Tube Rack 40×Φ16		400rpm

Note: These max. speeds are just for reference. We did the tests on the marble surface. Its friction coefficient is 0.32.

Warning: The rotation speed is inversely proportional to the load. When the instrument is running, it is recommended to adjust the rotation speed from low to high step by step and run the instrument at an appropriate speed to avoid spillage of liquids.

Section 2 Overview

2.1 Specifications

Category Number

Description	NA Cat. No.	NA/EU Cat. No.
Microplate Shaker	88861023 US plug	88861024 /15504070 Intl plug

Rotation Speed

Range	150 to 1000rpm
Orbit Diameter	2.5mm
Speed Accuracy	±1% of set speed up to 299rpm ±2% 300 to 1000rpm
Display	LED
Display Accuracy	1 rpm

Note: Maximum speed may vary with heavy or unbalanced loads.

Load

Maximum Load	1 kg (Clamps included)
Maximum Capacity (Centered on tray)	96-well Microplate-4 standard 6 with optional accessory

Power Supply

Requirement	AC100-240V, 50Hz/60Hz, 72VA
-------------	-----------------------------

Time

Timing Range	0min to 99h59min
--------------	------------------

Size

Overall Dimensions	415×293×137mm(16.3×11.5×5.4inch)
Tray Dimensions	275×235mm(10.8×9.3inch)
Packaging Dimensions	536×501×346mm(21.1×19.7×13.6inch)

Weight

Net Weight	11.5Kg(25.3lb)
Gross Weight	14Kg(30.8lb)

Others

Certificate	ROHS, WEEE, cCSAus, CE Mark
-------------	-----------------------------

2.2 Environmental Conditions

Application Environmental Conditions: indoor use

Altitude	≤2,000 m
Temperature	5°C to 40°C
Humidity	20% to 85%

Storage Environmental Conditions

Altitude	≤2,000 m
Temperature	0°C to 60°C
Humidity	20% to 90%, non-condensing

2.3 Safety Instructions

Please read the entire instruction manual before operating the Microplate Shaker.



WARNING DO NOT use the Microplate Shaker in a hazardous atmosphere or with hazardous materials for which the unit was not designed. Also, the user should be aware that the protection provided by the equipment may be impaired if accessories used are not provided or recommended by the manufacturer, or are used in a manner not specified by the manufacturer.

CAUTION ! To avoid electrical shock, completely cut off power to the unit by disconnecting the power cord from the unit or unplugging from the wall outlet. Disconnect unit from the power supply prior to maintenance and service. Any spills should be removed promptly. Bio hazard spills should be cleaned using approved liquid promptly. Solvent spills are a fire hazard. Stop the unit immediately, and **DO NOT** operate until clean up is complete and vapors have dissipated.

DO NOT immerse the unit for cleaning.

DO NOT operate the unit if it shows signs of electrical or mechanical damage.

Placement of Loads

Please place loads symmetrically during operation.

Symmetrical placement

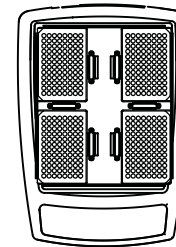
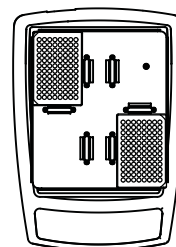

Section 3 Operation

This chapter covers the control panel and its operation.

3.1 Control Panel

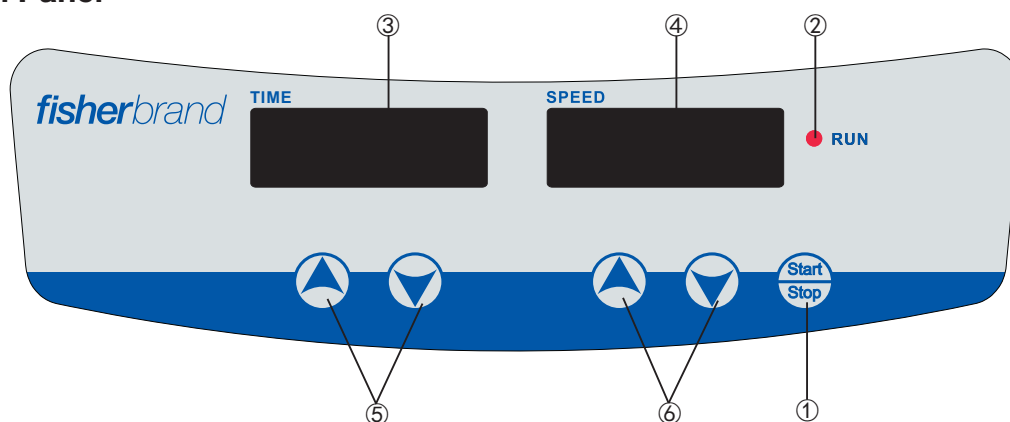

The front panel of the Microplate Shaker contains all the controls needed to operate the unit.

1. Start/Stop button: Start or stop the instrument.
2. RUN indicator light: The light is on when the instrument is running and off when the instrument is in standby.
3. TIME display window: The window shows cumulative time (in continuous mode) or remaining time (in timer mode). The range of time displayed is 0 to 99 hours and 59 minutes. The accuracy is 1 minute.
4. SPEED display window: The window shows set speed (when the instrument is in standby) or current speed (when the instrument is running).
5. Set Time Buttons: UP/DOWN Arrow buttons are used to increase/decrease the set time of the instrument.
6. Set Speed Buttons: UP/DOWN Arrow buttons are used to increase/ decrease the set speed of the instrument.

3.2 Installation

1. Connect all the components according to the figures shown on page 4 of this manual. Use grounded power outlet.
2. Press down the power switch on the back right side of the instrument and put it to the “I” state and then the instrument is in standby.

3.3 Settings

Time Settings

1. Continuous mode

Press the “▲” or “▼” arrow button below the TIME display window. When the number shown on the display window starts flashing, press “▼” arrow button to decrease the time to 00:00 and then release the button. The time setting is finished after the number shown on the display window has flashed twice.

2. Timer mode

Press the “▲” or “▼” arrow button below the TIME display

window. When the number shown on the display window starts flashing, press “▲” or “▼” arrow button to increase or decrease the time value. Release the button when the time shown on the display window reaches the set value. The time setting is finished after the number shown on the display window has flashed twice.

Speed Settings

Press the “▲” or “▼” arrow button below the SPEED display window. When the number shown on the display window starts flashing, press “▲” or “▼” arrow button to increase or decrease the speed value. Release the button when the speed shown on the display window reaches the set value. The speed setting is finished after the number shown on the display window has flashed twice.

Note: press the “▲” or “▼” arrow button for a longer time to accelerate the setting.

Run and Stop

1. Continuous Mode

Press “Start/Stop” button and the instrument will start running with the specified settings and the RUN indicator light will be on. The TIME display window will show the cumulative time and the SPEED display window will show the current speed. Press “Start/Stop” button again and the instrument will slow down until it stops. The instrument will then be in standby and the two display windows will show the set values.

2. Timer Mode

Press “Start/Stop” button and the instrument will start running with the specified settings and the RUN indicator light will be on. The TIME display window will show the remaining time and the SPEED display window will show the current speed. Press “Start/Stop” button again and the instrument will slow down until it stops. The instrument will then be in standby and the two display windows will show the set values.

Note:

To ensure shaking operation smooth and steady, it may take 1 minute for the microprocessor control system to accelerate the tray to the set speed.

Finish Operation

After the operation is finished, press the power switch at the back right side the instrument and put it into the "O" state
Unplug the instrument and store the instrument according to the storage guide.

Alarm Instructions

1. If the actual speed of the instrument exceeds or is lower than the set speed to reach alarm range, alarm will be triggered.
2. After the instrument alarms, LED RUN indicator light will go off, LED SPEED window will show "ERR1", and the machine will stop running, press any key to put the instrument in standby.
3. After the timer goes off, the buzzer will alarm and the instrument will stop running automatically.

Power Recovery

If the power supply is cut off suddenly while the instrument is in operation, the unit will automatically run at the previously set parameter upon power restoration. The display window will flash. Press any button to stop flashing.

3.4 Installation of Accessories

1. Loosen the screws of the tray with a cross screwdriver (figure 1), and replace the standard tray with platform large (figure 2).
2. Place the test rack holder onto the tray and fasten the 4 sunk screws.
3. Vertically clip the test tube rack into the holder and make sure there is no gap between the rack and the holder (figure 3).
4. Insert the test tube (figure 4).

Note: When using single test tube, it is recommended not to set the speed too high because of load imbalance.

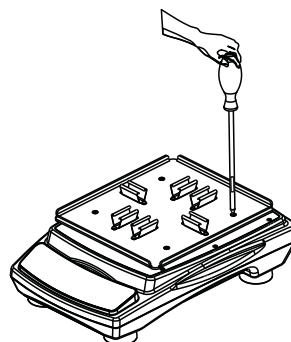

figure 1

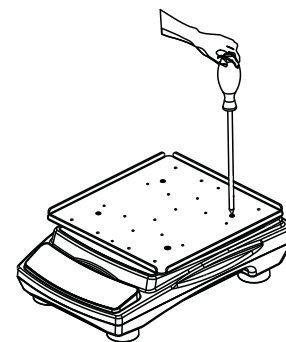

figure 2

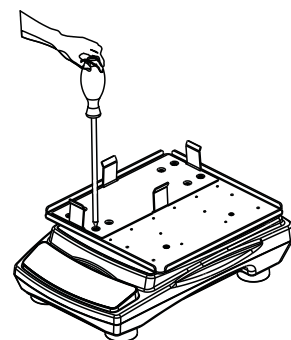

figure 3

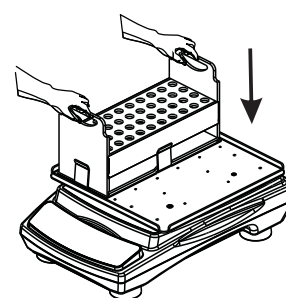

figure 4

Section 4 Safety Tips and Maintenance

Safety Tips

1. Use independent power supply.
2. Check if the local power supply voltage is suitable for use.
3. Do not drag the power supply cable when unplugging.
4. Do not use non-specified power cable or damage cable.
5. Service should only be performed by a qualified professional.
6. The power supply must be unplugged under the following situations:
 - a. When the unit is moved
 - b. When the electrical cabinet or the moving component is opened
 - c. When the equipment is malfunctioning
 - d. When the equipment is not in use

Maintenance

- a. This instrument uses brushless DC motor. It is maintenance free and has a long service time, high quality, and low noise level.
- b. Surface can be cleaned with a mild detergent and water.

Clean Spill

If accidental spillage of liquids caused by mishandling or contained breakage occurs on the surface of the instrument, please shut down the instrument and clean up the liquid immediately.

If the liquid has already spilled into the unit, cut off the power supply first and immediately clean up the liquid at the surface of the instrument. Place the instrument in a ventilated and dry environment for 24 hours before reuse. If the instrument is not functioning after drying for 24 hours, please contact the manufacturer.

Warning: Disassembling/Assembling without a qualified professional's guidance may cause malfunctioning of the instrument.

Section 5 Troubleshooting

Please refer to the following table to troubleshoot if any malfunction occurs. If the problem still exists, contact your local sales representative.

Error	Cause	Solution
Cannot start machine, LED display window off	Power disconnected	Connect the power
	Power switch off	Turn power switch on
	Power adaptor failure	Replace power adaptor
No shaking of the tray	Over-weighted or unbalanced load	Adjust the weight and position of load, decrease rotation speed
	Electrical malfunction	Contact Fisher Scientific
	Mechanical malfunction	Contact Fisher Scientific
Loud noise	Microplate loose	Adjust position of the microplate holder
	Tray loose	Fasten screws
Other	Keep record for maintenance	

Section 6 Optional Accessories/Spare Parts

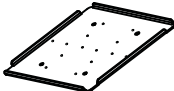
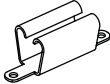
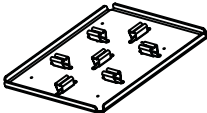
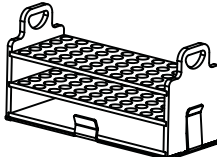
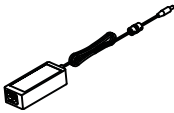
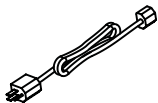
Description	NA Cat. No.	EU Cat. No.	Dimensions	Max. Qty	Figure
Platform Large	N/A	15855911	298×274mm	1	
96-well microplate holder	N/A	15865911	54×19×19mm (7pcs/pack)	7	
6 well platform assembly	88861173	15875911	298×274×21.5mm	1	
*Fixed Tube Rack 40×Φ14	88861148	15594110	262×112×140mm	2	
*Fixed Tube Rack 40×Φ16	88861149	15504120	262×112×140mm	2	
*Fixed Tube Rack 40×Φ18	N/A	15783798	262×112×140mm	2	
*Fixed Tube Rack 27×Φ22	N/A	15793798	262×112×140mm	2	
*Fixed Tube Rack 21×Φ30	N/A	15703808	262×112×140mm	2	
*Adjustable Tube Rack 40×Φ14	88861150	15514120	262×112×171mm	2	
*Adjustable Tube Rack 40×Φ16	88861151	15524120	262×112×171mm	2	
*Adjustable Tube Rack 40×Φ18	N/A	15713808	262×112×171mm	2	
*Adjustable Tube Rack 27×Φ22	N/A	15723808	262×112×171mm	2	
*Adjustable Tube Rack 21×Φ30	N/A	15733808	262×112×171mm	2	
General Power Adaptor (Spare Part)	88861154	15554120	AC 100~240V, 50/60HZ	1	
Power Cable US Plug (Spare Part)	88861155	N/A	125VAC, 10A, 1.8m	1	
Power Cable CN Plug (Spare Part)	88861156	N/A	250VAC, 10A, 1.8m	1	
Power Cable EU Plug (Spare Part)	88861157	15564120	250VAC, 16A, 1.8m	1	
Power Cable UK Plug (Spare Part)	88861158	15574120	250VAC, 13A, 1.8m	1	

*Only used on platform large (15855911).

Section 7 Warranty

When used in laboratory conditions and according to these operation instructions and maintenance, this product is warranted for 24 months against defective materials or workmanship. The 24 month warranty period begins from the delivery date of this product.

For product quality or performance issues, contact Fisher Scientific Customer Service.

North America

United States
1-800-766-7000
fishersci.com

Canada
1-800-234-7437
fishersci.ca

Europe

Austria:
+43(0)800-20 88 40
at.fishersci.com

Belgium:
+32(0)56 260 260
be.fishersci.com

Denmark:
+45 70 27 99 20
fishersci.dk

Germany:
+49(0)180 5258221
de.fishersci.com

Ireland:
+959(0)1 885 5854
ie.fishersci.com

Italy:
+39 02 950 59 478
it.fishersci.com

Finland:
+358(0)9 8027 6280
fishersci.fi

France:
+33(0)388 67 14 14
fishersci.fr

Netherlands:
+31(0)20 4887 70 00
nl.fishersci.com

Norway:
+47 22 95 59 59
fishersci.no

Portugal:
+351 21 425 33 50
pt.fishersci.com

Spain:
+34 002 239 303
es.fishersci.com

Sweden:
+46 31- 68 94 30
fishersci.se

Switzerland:
+41(0)56 618 41 11
ch.fishersci.com

UK:
+44(1)1509 555 500
fisher.co.uk

Find out more at **fishersci.com**