

BRANSON



Sonifier Power Supply

Instruction Manual

Branson Ultrasonics Corporation
41 Eagle Road
Danbury, CT 06813-1961 USA
(203) 796-0400
<http://sonifier.com>

EMERSON

Manual Change Information

At Branson, we strive to maintain our position as the leader in ultrasonics plastics joining, metal welding, cleaning and related technologies by continually improving circuits and components in our equipment. These improvements are incorporated as soon as they are developed and thoroughly tested.

Information concerning any improvements will be added to the appropriate technical documentation at its next revision. Therefore, when requesting service assistance for specific units, note the Revision information found on the cover of this document.

Copyright and Trademark Notice

Copyright © 2016 Branson Ultrasonics Corporation All rights reserved. Contents of this publication may not be reproduced in any form without the written permission of Branson Ultrasonics Corporation.

Sonifier is a registered trademark of Branson Ultrasonics Corporation.

Loctite is a registered trademark of Henkel Corporation, U.S.A.

UL is a registered trademark of Underwriters Laboratories.

CSA is a registered trademark of CSA International.

Other trademarks and service marks mentioned herein are held by their respective owners.

Foreword

Congratulations on your choice of a Branson Ultrasonics Corporation system!

The Branson Sonifier[®] ultrasonic cell disrupter/homogenizer is the newest generation of product using this sophisticated technology for a variety of customer applications. This Instruction Manual is part of the documentation set for this system, and should be kept with the equipment.

Thank you for choosing Branson!

Introduction

This manual is arranged into several structured chapters which will help you find the information you need to know to safely handle, install, set up, program, operate, and/or maintain this product. Please refer to the [Table of Contents](#) and/or the [Index](#) of this manual to find the information you may be looking for. In the event you require additional assistance or information, please contact our Product Support department (see [1.4 How to Contact Branson](#) for information on how to contact them) or your local Branson representative.



Table of Contents

Chapter 1: Safety and Support

1.1	Safety Requirements and Warnings	2
1.2	General Precautions	5
1.3	Warranty	7
1.4	How to Contact Branson	8
1.5	Returning Equipment for Repair	9
1.6	Obtaining Replacement Parts	11

Chapter 2: Introduction

2.1	Principle of Operation	14
2.2	Front Panel Controls and Indicators	16
2.3	Back Panel Connections	22

Chapter 3: Delivery and Handling

3.1	Delivery and Handling	24
-----	---------------------------------	----

Chapter 4: Technical Specifications

4.1	Technical Specifications	26
4.2	Physical Description	27

Chapter 5: Installation and Setup

5.1	Installation Checklist	30
5.2	System Component Description	31
5.3	Assembling the Equipment	39
5.4	Connecting Tips, Horns, and Converters	40
5.5	Input Power Requirements	43
5.6	Electrical Connections to Equipment	44
5.7	Guards and Safety Equipment	46
5.8	Ultrasonic Test	47

Chapter 6: Operation

6.1	Front Panel Controls	50
6.2	Control Modes	51
6.3	Results	54
6.4	System Configuration Registers	55
6.5	Setup Sequence	59
6.6	Save/Load Control Setup	92

Chapter 7: Maintenance

7.1	Maintenance and Troubleshooting	96
7.2	Reconditioning the Stack Interface	98
7.3	Troubleshooting Chart	101
7.4	Alarms/Errors	103

Appendix A: Application Information

A.1	Operating Considerations	106
A.2	Minimizing Undesirable Factors	108
A.3	Sterilizing and Preventing Cross-Contamination	109
A.4	Disrupting Tissues and Solids	110

A.5	Ultrasonic Irradiation on Various Biological Materials	111
Appendix B:Parts Lists		
B.1	Replacement Parts	124
B.2	Optional Items	125
B.3	Sonifier System Kits	126
Appendix C:Accessories		
C.1	Accessories	128
Appendix D:Handheld Converter		
D.1	Handheld Converter Overview	132
D.2	Handheld Converter Setup and Operation	134
D.3	Handheld Converter Ultrasonic Test	136

List of Figures

Chapter 1: Safety and Support

Figure 1.1	Safety Label on the Rear of the Sonifier Power Supply	4
Figure 1.2	Safety Label on the 102C Converter	4

Chapter 2: Introduction

Figure 2.1	The Sonifier Power Supply	14
Figure 2.2	Sonifier Power Supply Front Panel Controls.	16
Figure 2.3	LCD Description	19
Figure 2.4	Back Panel of the Sonifier Power Supply.	22

Chapter 3: Delivery and Handling

Chapter 4: Technical Specifications

Chapter 5: Installation and Setup

Figure 5.1	Double Step Microtip	32
Figure 5.2	Tapered Microtip	32
Figure 5.3	Disruptor Horn	32
Figure 5.4	Cup Horn	34
Figure 5.5	Flow-Thru Horn	35
Figure 5.6	Continuous-Flow Attachment	35
Figure 5.7	Soundproof Enclosure	37
Figure 5.8	Assembly for Standard Horn or Microtip	37
Figure 5.9	Assembly for Cup Horn.	38
Figure 5.10	Connecting the Tip to the Horn	41
Figure 5.11	User I/O	45

Chapter 6: Operation

Figure 6.1	Sonifier Power Supply User Interface	50
Figure 6.2	Results for Continuous Sonics - Time Mode (Example)	54
Figure 6.3	Continuous Sonics - Time Mode.	60
Figure 6.4	Continuous Sonics - Energy Mode	61
Figure 6.5	Continuous Sonics - Infinite Mode	62
Figure 6.6	Pulsed Sonics - Time Mode	64
Figure 6.7	Pulsed Sonics - Energy Mode	66
Figure 6.8	Pulsed Sonics - Infinite Mode (Time)	68
Figure 6.9	Pulsed Sonics - Infinite Mode (Energy).	70
Figure 6.10	Maximum Temperature - Continuous Sonics Mode.	71
Figure 6.11	Maximum Temperature - Pulsed Sonics Mode (Time)	73
Figure 6.12	Maximum Temperature - Pulsed Sonics Mode (Energy)	75
Figure 6.13	Temperature Limit - Continuous Sonics (Time) Mode	77
Figure 6.14	Temperature Limit - Continuous Sonics (Energy) Mode	79
Figure 6.15	Temperature Limit - Pulsed Sonics (Time) Mode	81
Figure 6.16	Temperature Limit - Pulsed Sonics (Energy) Mode.	83
Figure 6.17	Pulse Temperature - Continuous Sonics (Time) Mode.	85
Figure 6.18	Pulse Temperature - Continuous Sonics (Energy) Mode	87
Figure 6.19	Pulse Temperature - Pulsed Sonics (Time) Mode	89
Figure 6.20	Pulse Temperature - Pulsed Sonics (Energy) Mode	91
Figure 6.21	Save Control Setup to a Preset Memory Location.	92

Figure 6.22 Load Preset	93
Chapter 7: Maintenance	
Figure 7.1 Reconditioning Ultrasonic Stack Mating Surfaces	98
Appendix A: Application Information	
Appendix B: Parts Lists	
Appendix C: Accessories	
Appendix D: Handheld Converter	
Figure D.1 Handheld Converter	133
Figure D.2 Handheld Converter Setup.	135

List of Tables

Chapter 1: Safety and Support

Chapter 2: Introduction

Table 2.1	Front Panel Controls and Indicators	17
Table 2.2	LCD Icons	19
Table 2.3	Connections To The Sonifier Power Supply	22

Chapter 3: Delivery and Handling

Chapter 4: Technical Specifications

Table 4.1	Environmental Specifications	26
Table 4.2	Input Voltage	26
Table 4.3	Current Rating Fusing	26
Table 4.4	Continuous Power Rating	26
Table 4.5	Dimensions and Weight	27

Chapter 5: Installation and Setup

Table 5.1	Assembly for Standard Horn or Microtip	37
Table 5.2	Assembly for Standard Horn or Microtip	38
Table 5.3	Steps to Set Up Sonifier System	39
Table 5.4	Steps to Connect Horn to Converter	40
Table 5.5	Steps to Attach Tip to Horn.	41
Table 5.6	Suggested Amplitude Values for Various Horns	42
Table 5.7	Approximate Microtip Amplitudes	42
Table 5.8	Ultrasonic Test	47

Chapter 6: Operation

Table 6.1	Continuous Sonics Modes	51
Table 6.2	Pulsed Sonics Modes	51
Table 6.3	Maximum Temperature Modes	52
Table 6.4	Temperature Limit Modes	52
Table 6.5	Pulse Temperature Modes.	53
Table 6.6	Results for Continuous Sonics - Time Mode (Example)	54
Table 6.7	Modify Registers	55
Table 6.8	System Configuration Register Settings	55
Table 6.9	Continuous Sonics - Time Mode Parameters	59
Table 6.10	Continuous Sonics - Time Mode Setup Sequence	59
Table 6.11	Continuous Sonics - Energy Mode Parameters.	61
Table 6.12	Continuous Sonics - Energy Mode Setup Sequence	61
Table 6.13	Continuous Sonics - Infinite Mode Parameters	62
Table 6.14	Continuous Sonics - Infinite Mode Setup Sequence	62
Table 6.15	Pulsed Sonics - Time Mode Parameters	63
Table 6.16	Pulsed Sonics - Time Mode Setup Sequence	63
Table 6.17	Pulsed Sonics - Energy Mode Parameters	65
Table 6.18	Pulsed Sonics - Energy Mode Setup Sequence.	65
Table 6.19	Pulsed Sonics - Infinite Mode (Time) Parameters.	67
Table 6.20	Pulsed Sonics - Infinite Mode (Time) Setup Sequence	67
Table 6.21	Pulsed Sonics - Infinite Mode (Energy) Parameters	69
Table 6.22	Pulsed Sonics - Infinite Mode (Energy) Setup Sequence	69

Table 6.23	Maximum Temperature - Continuous Sonics Mode Parameters	71
Table 6.24	Maximum Temperature - Continuous Sonics Mode Setup Sequence	71
Table 6.25	Maximum Temperature - Pulsed Sonics Mode (Time) Parameters	72
Table 6.26	Maximum Temperature - Pulsed Sonics Mode (Time) Setup Sequence	72
Table 6.27	Maximum Temperature - Pulsed Sonics Mode (Energy) Parameters	74
Table 6.28	Maximum Temperature - Pulsed Sonics Mode (Energy) Setup Sequence	74
Table 6.29	Temperature Limit - Continuous Sonics (Time) Mode Parameters	76
Table 6.30	Temperature Limit - Continuous Sonics (Time) Mode Setup Sequence	76
Table 6.31	Temperature Limit - Continuous Sonics (Energy) Mode Parameters	78
Table 6.32	Temperature Limit - Continuous Sonics (Energy) Mode Setup Sequence	78
Table 6.33	Temperature Limit - Pulsed Sonics (Time) Mode Parameters	80
Table 6.34	Temperature Limit - Pulsed Sonics (Time) Mode Setup Sequence	80
Table 6.35	Temperature Limit - Pulsed Sonics (Energy) Mode Parameters	82
Table 6.36	Temperature Limit - Pulsed Sonics (Energy) Mode Setup Sequence	82
Table 6.37	Pulse Temperature - Continuous Sonics (Time) Mode Parameters	84
Table 6.38	Pulse Temperature - Continuous Sonics (Time) Mode Setup Sequence	84
Table 6.39	Pulse Temperature - Continuous Sonics (Energy) Mode Parameters	86
Table 6.40	Pulse Temperature - Continuous Sonics (Energy) Mode Setup Sequence	86
Table 6.41	Pulse Temperature - Pulsed Sonics (Time) Mode Parameters	88
Table 6.42	Pulse Temperature - Pulsed Sonics (Time) Mode Setup Sequence	88
Table 6.43	Pulse Temperature - Pulsed Sonics (Energy) Mode Parameters	90
Table 6.44	Pulse Temperature - Pulsed Sonics (Energy) Mode Setup Sequence	90
Table 6.45	Save Control Setup to a Preset Memory Location	92
Table 6.46	Load Control Setup from a Preset Memory Location	93

Chapter 7: Maintenance

Table 7.1	Torque Specifications	100
Table 7.2	System Trouble Analysis Chart	101
Table 7.3	Alarms/Errors	103

Appendix A: Application Information

Table A.1	Temperature Rise Variations for Different Volumes, Time and Amplitude Settings (°C) . 107	
Table A.2	Temperature Rise Variations for Different Volumes, Time and Amplitude Settings (°F) . 107	
Table A.3	Ultrasonic Irradiation on Various Biological Materials	111

Appendix B: Parts Lists

Table B.1	Replacement Parts List (250 W & 550 W)	124
Table B.2	Optional Items List	125
Table B.3	Sonifier System Kits	126

Appendix C: Accessories

Table C.1	Accessories List	128
-----------	----------------------------	-----

Appendix D: Handheld Converter

Table D.1	Handheld Converter	133
Table D.2	Handheld Converter Setup and Operation	134
Table D.3	Ultrasonic Test	136

Chapter 1: Safety and Support





1.1	Safety Requirements and Warnings	2
1.2	General Precautions	5
1.3	Warranty.	7
1.4	How to Contact Branson	8
1.5	Returning Equipment for Repair.	9
1.6	Obtaining Replacement Parts.	11

1.1 Safety Requirements and Warnings

This chapter contains an explanation of the different Safety Notice symbols and icons found both in this manual and on the product itself and provides additional safety information for ultrasonic processing. This chapter also describes how to contact Branson for assistance.

1.1.1 Symbols Found in this Manual

These symbols used throughout this manual warrant special attention:

WARNING	General Warning
	Warning indicates a hazardous situation or practice which, if not avoided, can result in serious injury or death.
WARNING	High Voltage Hazard
	High voltage. Turn power off before servicing.
WARNING	Corrosive Material Hazard
	Corrosive material. Avoid contact with eyes and skin. Wear proper protection.
CAUTION	General Warning
	Caution indicates a hazardous situation which, if not avoided, could result in minor or moderate injury.

CAUTION	Loud Noise Hazard
	Loud noise hazard.

NOTICE
Notice is used to address practices not related to personal injury. It contains important information. It might also alert the user to unsafe practices or conditions that can damage equipment if not corrected.

1.1.2 Symbols Found on the Product

Familiar graphic warning symbols are used to alert the user to items of concern or hazard. The following warning symbols appear on the Sonifier power supply.

Figure 1.1 Safety Label on the Rear of the Sonifier Power Supply

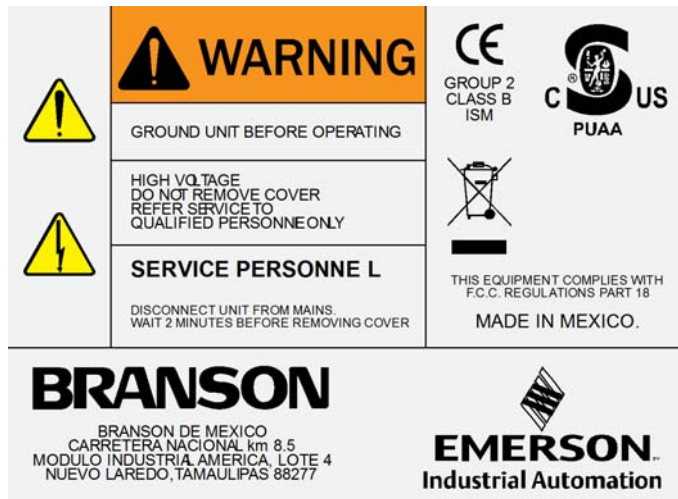
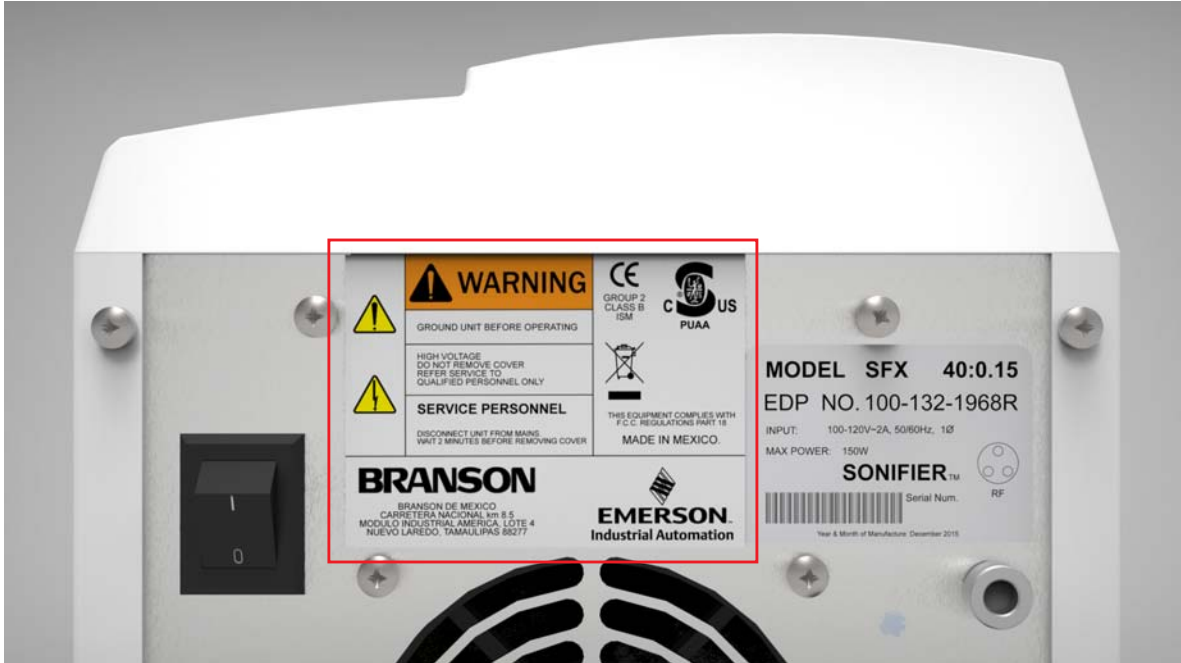



Figure 1.2 Safety Label on the 102C Converter

AVOID DIRECT CONTACT WITH TIP

1.2 General Precautions

Observe the following safety considerations when operating the Sonifier cell disruptor system:

CAUTION	General Warning
	<ul style="list-style-type: none"> • Make sure that the equipment is properly grounded. DO NOT operate if it is not. • The unit is equipped with a three-conductor cord and three-prong grounding-type plug, and must be plugged into a three-prong grounding-type wall receptacle. DO NOT under any circumstances remove the power cord ground prong. • DO NOT operate the equipment with the cover removed. High voltage is present within the equipment when connected. • DO NOT turn on the ultrasonics without the converter and horn or tip attached. • DO NOT touch the horn or tip when ultrasonics are active. When handling, removing, or attaching a horn or tip, be sure that the ON/OFF switch on the back of the unit is set to OFF. Touching the horn or tip while the unit is ON can result in serious personal injury. • DO NOT allow the horn or microtip to contact lab stands, beakers, test tubes or similar objects. Microtip failure may result. Breakage of glassware may result in the loss of a specimen. • DO NOT operate the equipment at more than 70% amplitude when using a microtip. • Appropriate eye protection should be worn to prevent possible splash injury.

CAUTION	Loud Noise Hazard
	<p>Sound level and frequency of the noise emitted during the ultrasonic processing may depend upon the specific type of application.</p> <p>Some parts vibrate at an audible frequency during the process. Some or all of these factors may result in an uncomfortable noise being emitted during processing.</p> <p>In such cases operators may need to be provided with personal protective equipment. See 29 CFR (Code of Federal Regulations) 1910.95 Occupational Noise Exposure.</p>

1.2.1 Intended Use of the System

The Sonifier ultrasonic cell disrupter/homogenizer can be used to disrupt cells, bacteria, spores, or tissue, and are ideal for initiating and accelerating chemical, biochemical, and physical reactions, and for degassing liquids. With the Sonifier system, you can prepare an emulsion to 0.01 micron, homogenize immiscible liquids, polymerize some materials, and depolymerize others.

1.2.2 Setting up the Workplace

Measures for setting up a workplace for safe operation of the Sonifier system are outlined in [Chapter 5: Installation and Setup](#).

1.2.3 Regulatory Compliance

This product meets electrical safety requirements and EMC (Electromagnetic Compliance) requirements for North America and the European Union.

All units comply with WEEE/RoHS requirements.

1.3 Warranty

Refer to the "Terms and Conditions of Sale" found on the back of your Invoice for information about the Warranty issued for your Branson products. If you have any questions, please contact your Branson representative. The product warranty information is summarized below.

WARRANTY

When used in accordance with written instructions and under normal operating conditions, Branson Ultrasonics Corporation equipment is guaranteed to be free of defects in MATERIAL and WORKMANSHIP for 3 years from the date of original delivery by Branson or by an authorized representative. Any unit which proves defective during the stated period will be repaired free of charge or replaced at the sole discretion of Branson Ultrasonics Corporation, F.O.B. Danbury, Connecticut, U.S.A. or an authorized repair station as advised by Branson, provided the defective unit is returned properly packed with all transportation charges prepaid. A limited warranty as specified may apply to certain components of the equipment.

WARRANTY EXCEPTIONS

This warranty shall not apply to equipment subjected to misuse, improper installation, alteration, neglect, accident or improper repair.

This warranty is limited to the original purchaser and is not transferable.

Horns and tips fabricated by Branson for use in equipment described in this manual are manufactured to exacting parameters. Using altered or modified horns and tips or horns and tips otherwise unqualified by Branson can produce undue stresses that may damage the equipment. Equipment failures resulting from using unqualified horns and tips are not covered by the Branson warranty.

Microtips are designed to give maximum mechanical energy output. Since they operate close to the stress limits of titanium, Branson cannot guarantee microtips against failure.

CONTACT YOUR BRANSON REPRESENTATIVE OR BRANSON ULTRASONICS CORPORATION, DANBURY, CONNECTICUT, SHOULD YOU HAVE ANY QUESTIONS CONCERNING HORN QUALIFICATION.

1.4 How to Contact Branson

The mailing address and telephone information for Branson is as follows:

Branson Ultrasonics
12013 Sara Rd
Laredo, TX 78043
Phone: +1 (203) 796-0551

Tell the operator which product you have and which person or department you need. If after hours, please leave a voice message with your name and return telephone number.

1.4.1 Before Calling Branson for Assistance

This manual provides information for troubleshooting and resolving problems that could occur with the equipment (see [Chapter 7: Maintenance](#)). If you still require assistance, Branson Product Support is here to help you. The following questionnaire lists the common questions you will be asked when you contact the Product Support department, to help identify the problem.

Before calling, determine the following information:

1. Your company name and location
2. Your return telephone number
3. Have your manual with you. If troubleshooting a problem, refer to [Chapter 7: Maintenance](#)
4. Know your equipment model and serial numbers (found on a data label on the units). Information about the horn (part number, gain, etc.) or other tooling may be etched into the tooling. Software- or -firmware based systems may provide a software version number, which may be required. (The Sonifier power supply provides the firmware information during power-up)
5. What horn and accessories are being used?
6. What are the setup parameters and mode?
7. Is your equipment in remotely operated system? If so, what supplies the "start" signal?
8. Describe the problem; provide as much detail as possible. For example, is the problem intermittent? How often does it occur? How long before it occurs if you are just powering up? If an error is occurring, which error or message?
9. List the steps you have already taken
10. What is your application, including the materials being processed?
11. Have a list of service or spare parts you have on hand (tips, horns, etc.)
12. Notes:

1.5 Returning Equipment for Repair

Before sending equipment for repair, provide as much information with the equipment to help determine the problem with the system. Fill in any details below or on a separate sheet.

1. Describe the problem; provide as much detail as possible. For example, is this a new problem? Is the problem intermittent? How often does it occur? How long before it occurs if you are just powering up?

2. Is your equipment in a remotely operated system? If so, is the problem related to Start/Stop control, or interaction with PLC's or other devices, etc.?

3. If the problem is with an external signal or output, which one?

4. If known, include plug/pin # (e.g., P29, pin #3):

5. What are the setup parameters?

6. What is your application (e.g., continuous, pulse, temperature, etc.)?

7. Name and phone number of the person most familiar with the problem:

8. Notify Branson prior to shipping the equipment.

NOTICE

To return equipment to Branson, you must first obtain an RGA number from Branson, or the shipment may be delayed or refused.

9. For equipment not covered by warranty, include a purchase order for the repair costs to avoid delay

10. Pack carefully in original packing material to avoid damage in shipment

11. Return general repairs by any desired method. Send priority repairs by air freight

12. Prepay the transportation charges FOB Laredo, TX, U.S.A.

13. Notes:

1.5.1 Returning Equipment for Repair

Before sending equipment for repair, provide as much information with the equipment to help determine the problem with the system. Use the previous page to record necessary information.

NOTICE

To return equipment to Branson, you must first obtain an RGA number from Branson, or the shipment may be delayed or refused.

Americas

Call the Repair department to obtain a Returned Goods Authorization (RGA) number. If requested, the Repair department can send you a facsimile of the Returned Goods Authorization form to fill out and return with your equipment.

Branson Ultrasonics
12013 Sara Rd
Laredo, TX 78043
Phone: +1 (956) 723-6311

1. Provide as much information as possible that will help identify the need for repair. Include a copy of the previous page with your information filled in
2. Carefully pack the equipment in original packing cartons
3. Clearly label all shipping cartons with the RGA number on the outside of cartons as well as on your packing slip, along with the reason for return
4. Return general repairs by any convenient method. Send priority repairs by air freight
5. You must prepay the transportation charges FOB Laredo, TX, U.S.A.

Europe and Asia

Please contact your Sonifier distributor for information pertaining to service and repair.

1.6 Obtaining Replacement Parts

You can reach Branson Parts Store at the following telephone numbers:

Branson Part Store

Direct telephone number: 877-330-0406

Fax number: 877-330-0404

Many parts can be shipped the same day if ordered before 2:30 p.m., Eastern time.

A parts list is found in [Appendix B: Parts Lists](#) of this manual, listing descriptions and part numbers. If you need replacement parts, coordinate the following with your purchasing agent:

- Purchase order number
- Ship to information
- Bill to information
- Shipping instructions (air freight, truck, etc.)
- Any special instructions (for example, "Hold at the airport and call"). Be sure to give a name and phone number
- Contact name information



Chapter 2: Introduction

2.1	Principle of Operation.	14
2.2	Front Panel Controls and Indicators	16
2.3	Back Panel Connections	22

2.1 Principle of Operation

The Sonifier system is often used by laboratory personnel in the medical and chemical process fields. The system consists of three core elements: the Sonifier power supply, the converter and horn. The system can also interface with a temperature probe, and user custom digital control interface.

Figure 2.1 The Sonifier Power Supply



The Sonifier power supply converts AC line voltage to 20 kHz or 40 kHz electrical energy. This high-frequency electrical energy is fed to the converter where it is converted to mechanical vibrations. The heart of the converter is an electrostrictive element which, when subjected to an alternating voltage, expands and contracts. The converter vibrates in a longitudinal direction and transmits the motion to the horn tip immersed in the solution, which causes cavitation.

The implosion of microscopic bubbles or cavities in the solution results, causing the molecules in the medium to become intensely agitated.

The Sonifier system is a constant amplitude device. As the load or pressure on the horn face increases, the Sonifier system develops more power to maintain the amplitude for any given output control setting. When the horn is operated in air, it is subjected to minimum pressure, and minimum power is required to maintain amplitude.

The load increases when the horn is immersed in a liquid; the more viscous the liquid, the higher the load and the more power developed. If a flow-through cell that can be pressurized is used, thereby increasing pressure on the horn, even more power is developed. For any given application, more power results when a horn of higher amplitude or larger radiating surface is used, or when any horn is driven at higher amplitude.

By setting various operation parameters, you can precisely control the way in which ultrasonics are applied to the samples or liquids for processing. You can:

- Specify the time duration of the ultrasonic processing
- Specify the amount of energy you want to deliver to the sample or liquid during processing
- Adjust the amplitude setting between 10% and 100% of maximum amplitude (microtip 70% maximum)
- Prevent excessive temperature increase in the sample or liquid by setting ultrasonics to operate in Pulse mode or pausing the ultrasonic cycle
- Bring a sample or liquid to a desired temperature and hold it there, varying by only a few degrees, for a desired duration using the Pulse Temperature mode
- Set the maximum allowable temperature in the sample or liquid, so that ultrasonics will stop automatically when the specified temperature is reached

NOTICE

Some operations require the optional temperature probe.

2.2 Front Panel Controls and Indicators

This section describes the controls that you use to operate the Sonifier power supply. These controls allow for accuracy and repeatability of control settings. A detailed description of how and when to use each front panel control, the valid formats for the data that you enter, and the response you receive from the system when you use each of these controls is provided in [Chapter 6: Operation](#).

The Sonifier power supply is equipped with a keypad and LCD on the front panel of the unit. With the keypad, you can set functional modes of operation and control parameters. Availability of the various functions depends on the control mode or state of the system. If an error condition exists, the Alarm/Error icon will flash and the beeper will sound three times.

Some functions of the Sonifier power supply can be controlled through the external input connector located on the rear of the unit. [2.3 Back Panel Connections](#) describes the back panel of the unit.

2.2.1 Sonifier Power Supply Front Panel

Figure 2.2 Sonifier Power Supply Front Panel Controls



Table 2.1 Front Panel Controls and Indicators









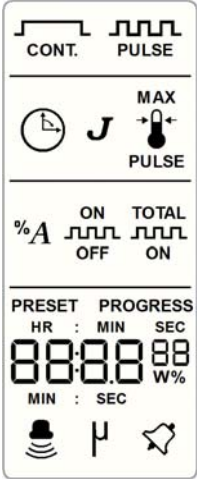

Reference	Description
 <p>The LCD display is divided into four sections. The top section shows 'CONT.' and 'PULSE' modes with corresponding waveforms. The second section shows a clock icon, a 'J' icon, and a 'MAX PULSE' icon with a '+' sign. The third section shows '%A' and 'TOTAL' indicators with 'ON' and 'OFF' labels and waveforms. The bottom section shows 'PRESET' and 'PROGRESS' indicators, a digital display for 'HR : MIN SEC' and 'MIN : SEC', and 'W%' indicator. At the bottom are icons for a speaker, a 'P' icon, and a star icon.</p>	<p>LCD</p> <p>The LCD allows for easy navigation, configuration, and for communicating control settings and results.</p> <p>The LCD is divided into four sections:</p> <ul style="list-style-type: none"> • The first and second sections are used to highlight the current control mode when running a preset, to select the control mode when configuring a preset, and to indicate when Time, Energy or Temperature parameters entries are required • The third section is used to indicate available parameters for each control mode and to indicate to which parameter corresponds the value shown on the LCD bottom section • The fourth section is used to display and edit parameter and system configuration register values; to select presets and registers; to display real time cycle data and overall progress; and to indicate alarms/errors or that a cycle is running <p>For a detailed description of the display icons refer to Table 2.2 LCD Icons.</p>
 <p>Two blue square buttons with white triangular arrows pointing up and down.</p>	<p>Up/Down Keys</p> <p>Press the Up and Down keys to initiate a change to the current control settings, when the system is displaying the ready screen. These keys are also used to select system configuration registers and modify parameter values.</p>
 <p>Two blue square buttons with white triangular arrows pointing left and right.</p>	<p>Left/Right Keys</p> <p>Press the Left and Right keys to select control modes, to move horizontally between digits, and to move between different result screens.</p>
 <p>A blue square button with a white arrow pointing left and the word 'ENTER' below it.</p>	<p>Enter Key</p> <p>Press the Enter key to initiate a change to the current control settings, when the system is displaying the ready screen. This key is also used to select system configuration registers and presets, and to accept control setting changes.</p>
 <p>A blue square button with the word 'PRESET' in white.</p>	<p>Preset Key</p> <p>Press the Preset key to select a memory location to save the current control settings or to recall stored settings. For more information on saving control settings presets see 6.6 Save/Load Control Setup.</p>

Table 2.1 Front Panel Controls and Indicators

Reference	Description
	<p>ESC Key</p> <p>Press the ESC key to return to the ready screen when modifying control settings. Any setting modifications that were applied before, by pressing the enter key, will be saved.</p>
	<p>Test Key</p> <p>Press and hold the Test key to turn on sonics. A test first tunes to the ultrasonic converter's operating frequency at low amplitude, then ramps the amplitude to the current setting.</p>
	<p>Microtip Key</p> <p>Press the Microtip key when using a microtip probe. This limits amplitude to 70%, thus preventing damage to the probe.</p>
	<p>Reset Key</p> <p>Press the Reset key to reset errors and alarms.</p>
	<p>Pause Key</p> <p>Press the Pause key to pause an ultrasonic cycle. Press Pause key again to resume current cycle.</p> <p>NOTICE Pause button is disabled when using a handheld converter.</p>
	<p>Start/Stop Key</p> <p>Press the Start/Stop key to turn ultrasonics on/off. To configure as a press and hold button, see 6.4 System Configuration Registers.</p>

2.2.2 LCD Description

Figure 2.3 LCD Description

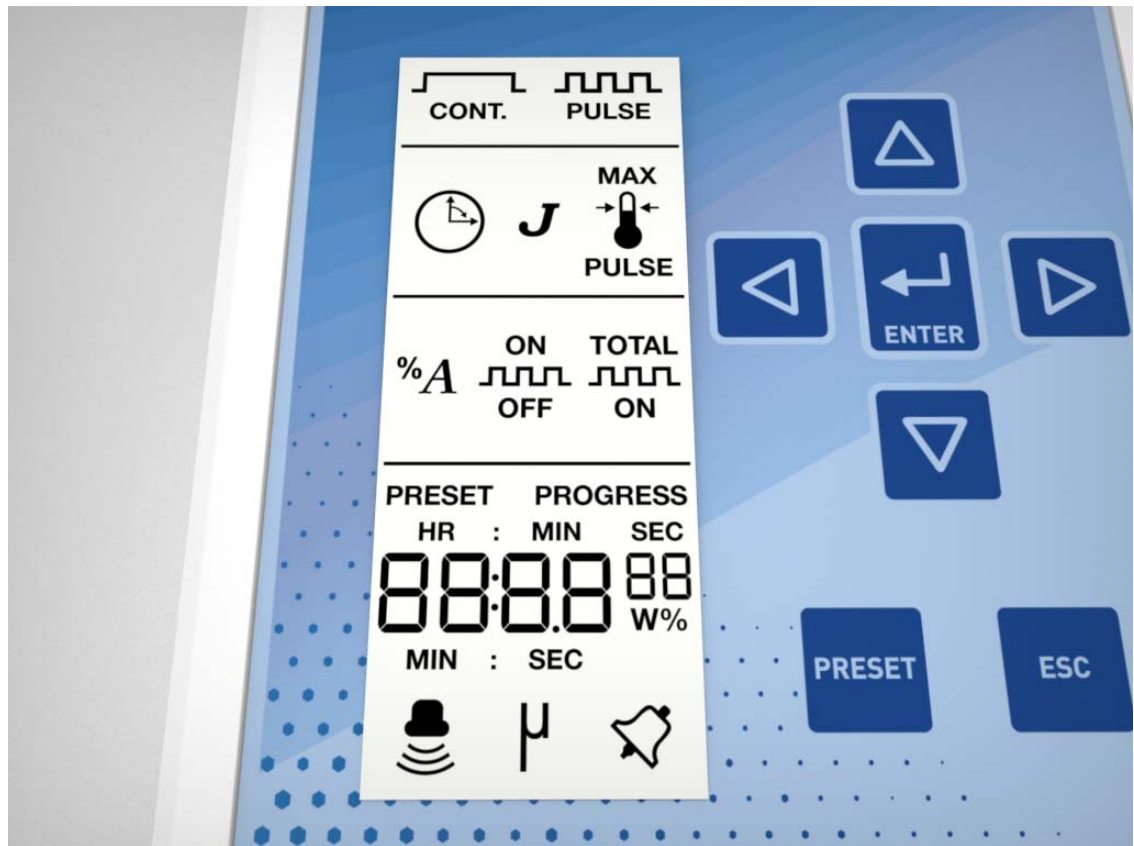

Table 2.2 LCD Icons

Reference	Description
	<p>Numeric Display</p> <p>Indicates parameter settings, parameter values, system configuration register numbers, register settings, and preset numbers.</p>
	<p>Continuous Mode Icon</p> <p>Indicates Ultrasonic energy will be delivered continuously during the cycle.</p>
	<p>Pulse Mode Icon</p> <p>Indicates ultrasonic energy will be delivered in controlled bursts or pulses.</p>
	<p>Time Mode Icon</p> <p>Indicates time is the main control parameter.</p>

Table 2.2 LCD Icons









Reference	Description
J	Joules Icon Indicates energy is the main control parameter.
MAX 	Max Temperature Icon Indicates the cycle is controlled to prevent the temperature from exceeding a set maximum. When used as a controlled mode it indicates the cycle will end when a set maximum temperature is reached.
 PULSE	Pulse Temperature Icon Indicates the cycle is controlled to adjust the pulse duty cycle (ratio of On and Off times for pulses) to control the temperature to stay between the set Pulse and Max temperatures during the cycle.
	Temperature Icon Indicates the temperature sensed by the probe during the cycle or the resulting temperature at the end of the cycle.
%A	Amplitude Icon Indicates the set amplitude at the tip of the horn as a percentage of the maximum available amplitude of mechanical vibrations.
ON 	On Time Icon Used to set the amount of on time in pulsed modes.
 OFF	Off Time Icon Used to set the amount of off time in pulsed modes.
TOTAL  ON	Total On Time Icon Used to set the total amount of pulsed time.
PRESET LO	Load Icon Indicates that the number shown on the numeric display corresponds to the memory location from which the current control settings are to be recalled. For more information on saving and recalling control setting presets see 6.6 Save/Load Control Setup .
PRESET SA	Preset Save Icon Indicates that the number shown on the numeric display corresponds to a memory location where control settings are to be saved. For more information on saving and recalling control setting presets see 6.6 Save/Load Control Setup .

Table 2.2 LCD Icons

Reference	Description
	Sonics Active Indicator Indicates ultrasonics is running.
	Microtip Icon Indicates microtip mode is active. When active, amplitude max setting is 70%.
	Alarm/Error Icon A flashing icon which indicates an alarm or error condition.

2.3 Back Panel Connections

Figure 2.4 Back Panel of the Sonifier Power Supply



Table 2.3 Connections To The Sonifier Power Supply

Item	Name	Function
1	Power Switch	Turns the unit on/off.
2	Temperature Probe Connector	Phone-jack style connector for an optional temperature probe.
3	IEC/C14 Power Connector	To connect the Sonifier power supply to a grounded electrical power source using the provided detachable line cord.
4	Fuse Holder	Provides access to a replaceable protective fuse.
5	User I/O D-Sub Connector (J2)	Connects the Sonifier power supply to a PLC controller for remote control.
6	3 Pin RF Connector	Connects the Sonifier power supply to the ultrasonic converter.

Chapter 3: Delivery and Handling

3.1 Delivery and Handling 24

3.1 Delivery and Handling

The Sonifier power supply has no special handling constraints. On receipt of your Sonifier system, take the following steps:

1. Inspect the carton for signs of damage
2. Open the carton and locate the packing list
3. Carefully unpack the components and check them against the packing list
4. Save all packing materials in case the equipment needs to be shipped
5. Inspect the components for any damage that may have occurred during shipping

Report all shipping damage to your carrier.

Chapter 4: Technical Specifications

4.1	Technical Specifications	26
4.2	Physical Description	27

4.1 Technical Specifications

4.1.1 Environmental Specifications

The Sonifier system has the following environmental specifications.

Table 4.1 Environmental Specifications

Environmental Condition	Acceptable Range
Operating Temperature	+41°F to +104°F (+5°C to +40°C)
Storage Temperature	-13°F to +131°F (-25°C to +55°C) (short time exposure not to exceed +158°F (70°C) in 24 hours)
Humidity	Maximum 95%, non-condensing

4.1.2 Electrical Specifications

The following tables list input voltage and current requirements for the Sonifier power supply.

Table 4.2 Input Voltage

Line Voltage
100 to 120 V @ 50/60Hz
200 to 240 V @ 50/60Hz

Table 4.3 Current Rating Fusing

Model	Power	Current Rating
20 kHz	250 W	1.5 Amp Max. @ 200-240 V / 10 Amp fuse
	250 W	4.5 Amp Max. @ 100-120 V / 10 Amp fuse
	550 W	9.5 Amp Max. @ 100-120 V / 10 Amp fuse
	550 W	6 Amp Max. @ 200-240 V / 10 Amp fuse
40 kHz	150 W	1 Amp Max. @ 200-240 V / 10 Amp fuse
	150 W	2 Amp Max. @ 100-120 V / 10 Amp fuse

Table 4.4 Continuous Power Rating

Model	Power	Continuous Power
20 kHz	250 W	250 W
	550 W	250 W
40 kHz	150 W	150 W

4.2 Physical Description

This section describes the physical dimensions of the Sonifier power supply.

Table 4.5 Dimensions and Weight

Length	Width	Height	Weight
13.7" (348 mm)	8" (203 mm)	9.5" (242 mm)	14-15 lb (6.5 kg)

NOTICE

Dimensions are nominal.

Chapter 5: Installation and Setup

5.1	Installation Checklist	30
5.2	System Component Description	31
5.3	Assembling the Equipment.	39
5.4	Connecting Tips, Horns, and Converters	40
5.5	Input Power Requirements	43
5.6	Electrical Connections to Equipment	44
5.7	Guards and Safety Equipment	46
5.8	Ultrasonic Test	47

5.1 Installation Checklist

The Sonifier system is shipped with an appropriate cordset. Additional items required to operate the Sonifier system are detailed in [5.2 System Component Description](#).

The unit should be positioned away from radiators and heating vents. A fan inside the unit maintains a safe operating temperature by circulating air over the components. Therefore, place the unit so that the air intake at the back of the Sonifier power supply is not blocked. Periodically, unplug the unit and clean the air intake and also the air exhaust underneath the front of the unit to ensure that dust or dirt is not restricting the flow of air.

If the Sonifier system is to be used for remote operation, ensure that the unit is situated within full view of the operator, to prevent injury or equipment damage through an accidental or automatic start-up.

A Fan Filter Kit (EDP 101-063-614) is available (factory installed only), and is recommended for use in areas that are high in airborne contamination environments. The kit contains 2 filters.

5.2 System Component Description

5.2.1 Standard Components

The standard system components are:

- Sonifier power supply
- Power cord
- Converter
- Horn (and tips)

5.2.2 Optional Items

A complete list of optional items is provided in [Appendix B: Parts Lists](#).

5.2.3 Accessories

Disruptor horns, various horn tips, and a variety of chambers or vessels for batch or continuous processing are available for use with Branson Sonifier systems. For a list of Accessories, refer to [C.1 Accessories](#).

5.2.4 Microtips

Particularly useful for processing small volumes, microtips are available in several designs, tapered and stepped, to meet your application requirements. A coupling section may be used with a microtip horn for certain applications.

Figure 5.1 Double Step Microtip

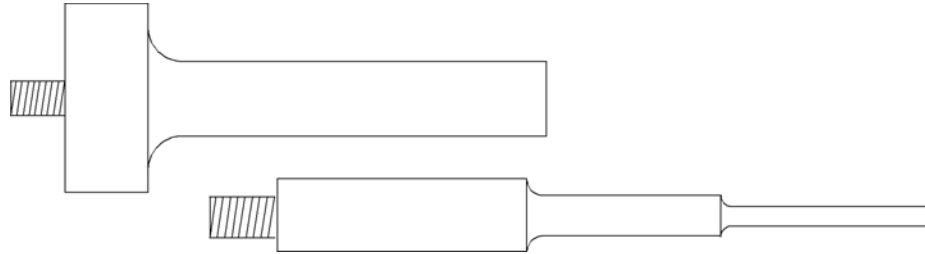

NOTICE

Do not use the double step microtip with the disruptor horn.

Figure 5.2 Tapered Microtip

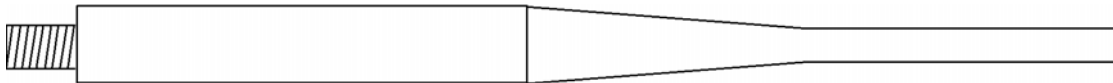
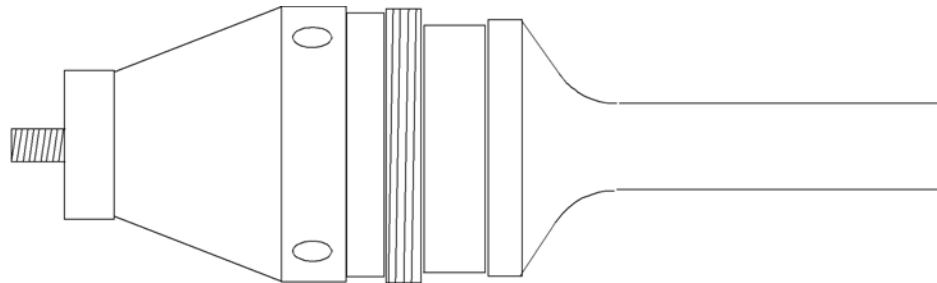

Figure 5.3 Disruptor Horn



NOTICE

DO NOT allow the horn or microtip to contact lab stands, beakers, test tubes or similar objects. Microtip failure may result. Breakage of glassware may result in the loss of a specimen.

Disruptor horns are the base for many microtip applications. Disruptor horns are threaded so that they may also be inserted into a flow-thru chamber attachment (see [5.2.7 Flow-Thru Horn](#)). When threaded together, a closed chamber is formed between the Tissue Disruptor and the cavity of the flow-thru attachment. The tissue disruptor may also be used alone.

The tapered microtip attaches directly to a standard 1/2 inch tapped disruptor horn. The amplitude at the end of a tapered tip is three and one-half times greater than that of the standard horn. The tapered tip is recommended for difficult applications such as spores, fungi, yeast, muscle, and connective tissue. Excellent results can be achieved on volumes ranging from 3 to 20 ml in a comparatively short period of time. The diameters of the tapered microtips are 1/8 inch (3.2 mm), 3/16 inch (4.8 mm), and 1/4 inch (6.4 mm).

The stepped microtip is a two-piece unit, consisting of a coupling section and a lower double-step tip. Because the coupling section is attached directly to the converter, the standard disruptor horn must be removed prior to using the stepped microtip. Recommended for use on extremely small volumes, the stepped microtip can be used to treat volumes ranging from 0.5 to 20 ml. Applications for this tip include red and white blood cells, tissue culture cells, HeLa cells, and the complete range of cells that have low to medium resistance to breakage.

To prevent foaming or aerosoling while processing small quantities with the tapered or stepped microtips, the use of a conical-shaped tube such as a reaction vial or a cut down centrifuge tube is recommended.

NOTICE

When using microtips, do not exceed a maximum Amplitude Control setting of 70%. The microtip will break if driven at higher amplitudes.

5.2.5 Tissue Disruptor

Designed for disintegration of difficult tissues, this stainless steel accessory has a specially constructed cell bottom that holds up to six grams of tissue. A water jacket may be provided for cooling.

5.2.6 Cup Horn

Figure 5.4 Cup Horn

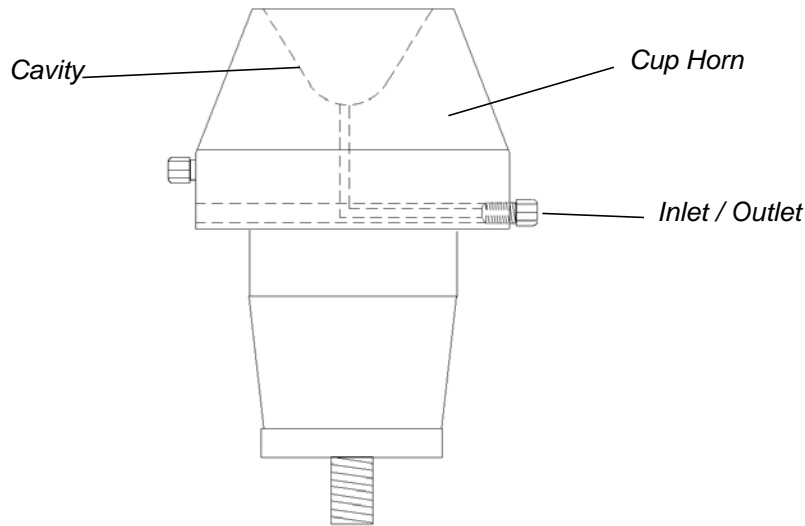

Cup horns allow materials to be treated in small vials or test tubes without immersing the ultrasonic horn or microtip in the material, thereby providing completely sterile conditions. A cup horn is attached directly to the converter, and the assembly is mounted upside-down on the lab stand with the cup horn at the top. With chilled water in the cup horn, test tubes are suspended in the cup with the contents of the tubes just below the water level. Ultrasonic energy is then conducted from the surface of the horn, through the water and test tube walls, to the contents of the tube.

Some energy loss may occur when applying ultrasonics in this indirect way, and processing can take longer than if the ultrasonic horn were immersed directly in the solution.

There are two types of cup horn, a high intensity unit that will accommodate a single test tube, and a larger unit for multiple test tubes. The high intensity cup horn has a concave bottom that focuses the ultrasonic energy on the bottom of the tube. The larger unit, with a diameter of two or three inches, allows the immersion of multiple test tubes. The larger cup horns have clear plastic walls, which permit easy viewing of the activity in the tubes during processing. Both types of cup horn are designed to allow chilled water to circulate through the cup to prevent heating of the solution as a result of the ultrasonic activity.

NOTICE

The bottom of the test tubes should not be in contact with the surface of the ultrasonic horn. Such contact could cause breakage and loss of sample.

5.2.7 Flow-Thru Horn

Figure 5.5 Flow-Thru Horn

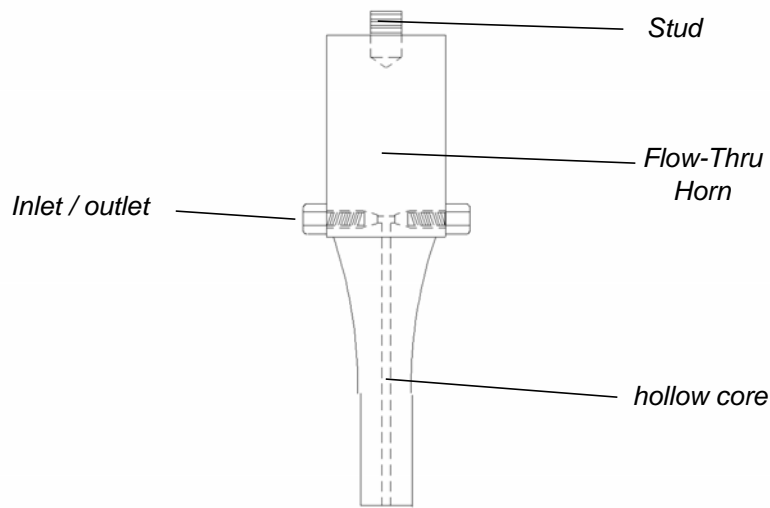

The flow-thru horn has two inputs or orifices at the non-vibrating, nodal point of the horn. A pre-mixed substance is fed through one of the inputs while the horn is ultrasonically activated. Because two inputs are available, two different types of material can be treated simultaneously for mixing or emulsifying. The processed solution exits at the tip of the horn. The horn can be used as a continuous-flow device to collect the solution in one large vessel.

5.2.8 Continuous-Flow Attachment

Figure 5.6 Continuous-Flow Attachment

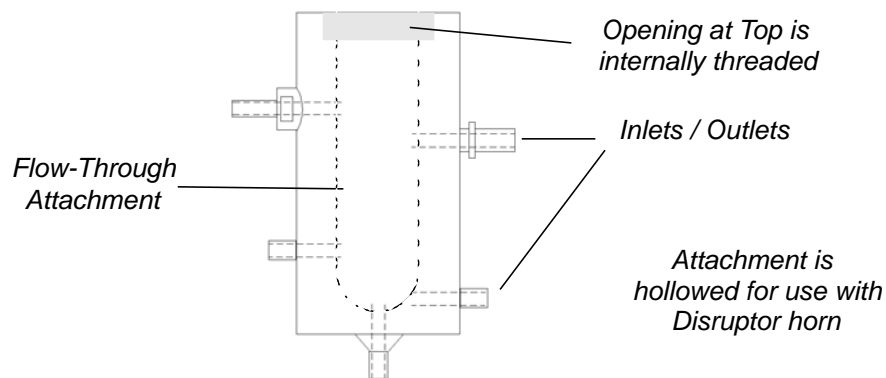

This attachment, which is screwed onto the disruptor horn, permits continuous processing of low-viscosity materials at rates of up to 38 liters per hour. Designed primarily for emulsifying, dispersing, and homogenizing, the attachment will disrupt most cells, with the exception of the more difficult species. The materials being treated can be passed through the attachment more than once to obtain desired results. For cooling, a water jacket with input, output, and overflow connections is provided.

5.2.9 Rosett Cell

The Rosett Cell, made of borosilicate glass, has a conical shape with three side arms, through which the solution is driven by pressure produced from vibrations from the ultrasonic horn, thereby exposing the substance to ultrasonic energy repeatedly during circulation. When the Rosett Cell is immersed in a cooling bath, the enlarged glass surface area and circulation through the side arms provide an efficient means of heat exchange.

The Rosett Cell is available in three sizes: 8-25 ml, 25-180 ml, and 35-300 ml.

5.2.10 Flow-Thru Rosett Cell

The Flow-Thru Rosett Cell is equipped with its own water cooling jacket, with intake and output connections for continuous processing and a double chamber for cooling. Normally, adequate cooling can be achieved by connection to the cold water tap or by using a closed circuit system. An ice/salt water solution will maintain a temperature below 0°C. Since the double chamber is made of glass, the substance can be easily observed during treatment. The Flow-Thru Rosett Cell is not suited for difficult cells.

5.2.11 Soundproof Enclosure

Although ultrasound is above the normal range of human hearing, audible sound sometimes occurs when liquids are treated ultrasonically, especially due to cavitation produced by ultrasonic vibration. The Soundproof Enclosure can be used to reduce this to an acceptable level. It is especially useful when the Sonifier system is used for extended periods of time.

The soundproof enclosure is also useful at minimizing splashing while the ultrasonic cycle is running. Cooling within the enclosure may be required for certain applications. Detail of the enclosure may vary from those depicted below.

Figure 5.7 Soundproof Enclosure

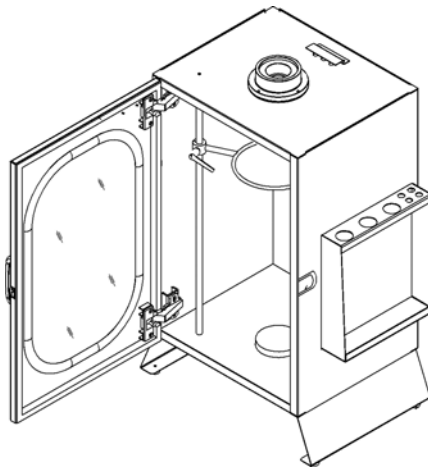

Figure 5.8 Assembly for Standard Horn or Microtip

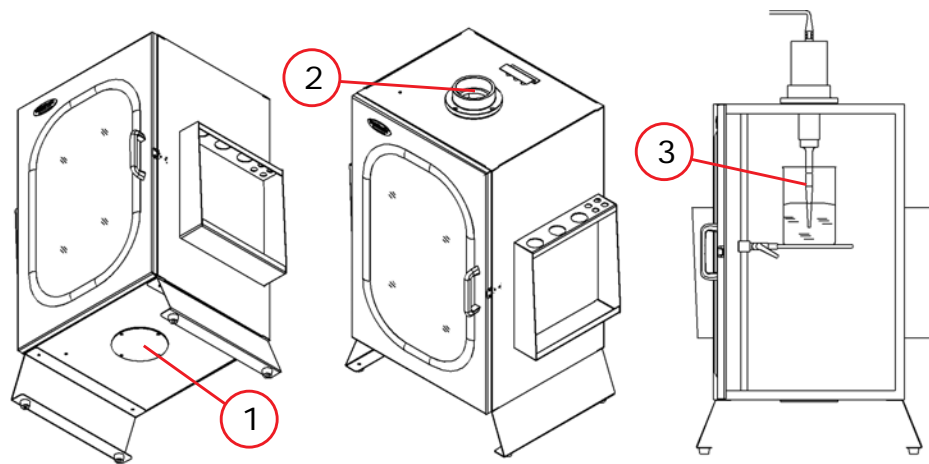

Table 5.1 Assembly for Standard Horn or Microtip

Item	Description
1	Cover
2	Neck (Reversible)
3	Horn or Microtip

Figure 5.9 Assembly for Cup Horn

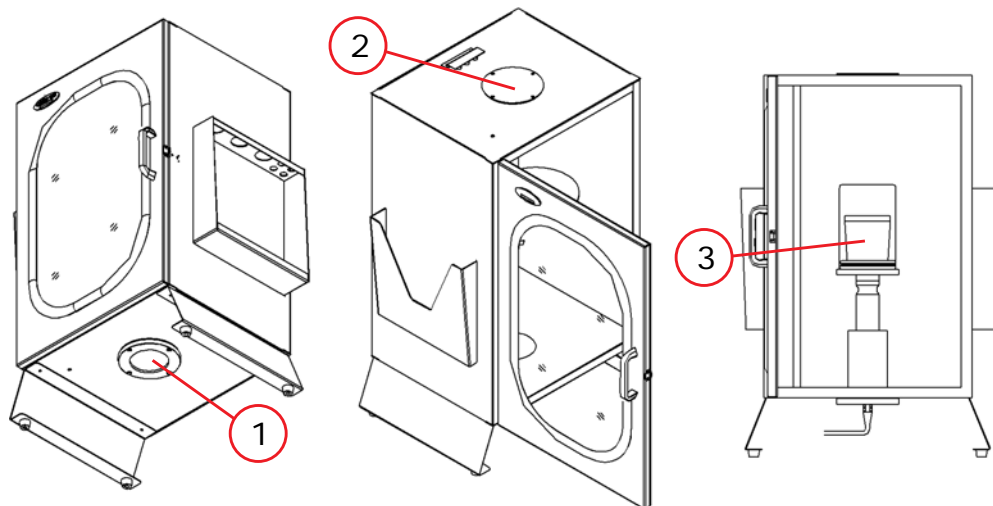

Table 5.2 Assembly for Standard Horn or Microtip

Item	Description
1	Neck (Inverted)
2	Cover
3	Cup Horn

5.3 Assembling the Equipment

The Sonifier power supply is pre-assembled and requires no special tools, however other components must be connected to the unit in order for the system to operate. Some assembly of the ultrasonic horn is required, as described in the following sections.

5.3.1 Setup Procedure

To set up your Sonifier system, take the following steps:

Table 5.3 Steps to Set Up Sonifier System

Step	Action
1	Connect the tip, horn, and converter, following the procedure in 5.4 Connecting Tips, Horns, and Converters .
2	Mount the converter/horn assembly in a laboratory stand or other suitable support. Secure the clamp on the converter housing.
3	Set the ON/OFF switch on the rear of the unit to the O (OFF) position
4	Plug the line cord into the unit, and then into an appropriate electrical power outlet, ensuring that the Sonifier power supply is grounded to prevent electrical shock.

5.4 Connecting Tips, Horns, and Converters

NOTICE

To remove a horn, use spanner wrenches shipped with the system. Never attempt to remove a horn by holding the converter housing in a vise. If necessary, secure the largest portion of the horn in a soft-jawed vise. See [5.4 Connecting Tips, Horns, and Converters](#).

5.4.1 Connecting the Horn to the Converter

To connect the horn to the converter, take the following steps:

Table 5.4 Steps to Connect Horn to Converter

Step	Action
1	Clean the contacting surfaces of the converter and horn, and remove any foreign matter from the threaded stud and threaded hole.
2	Use appropriate mylar washer, NOT silicone grease.
3	Thread the horn stud into the converter and tighten, using spanner wrenches. The recommended torque for 20 kHz tooling is 220 inch-pounds (24.85 Nm). For 40 kHz tooling torque to 95 inch-pounds (8 Nm).

A standard flat tip, recommended for processing liquids, is supplied with tapped horns. Other tip configurations are available for experimental work on applications where the ultrasonic vibrations are transmitted directly into the solution. The shape of the horn influences the direction in which the ultrasonic vibrations are delivered from the horn.

5.4.2 Connecting the Tip to the Horn

To attach the tip to the horn, take the following steps:

Table 5.5 Steps to Attach Tip to Horn

Step	Action
1	Clean contacting surfaces of the horn and tip, and remove any foreign matter from the threaded stud and threaded hole. NOTICE The tip must be installed clean and dry, or the Sonifier system may not tune and operate correctly.
2	Hand-assemble the tip to the horn.
3	Using a spanner wrench on the horn and an open-end wrench on the tip, tighten the tip. See Figure 5.10 Connecting the Tip to the Horn . Torque specifications for the various threaded tips follow: 1/4-20 — tighten at 90 inch-lbs./10.16 Newton-meters. 3/8-24 — tighten at 180 inch-lbs./20.33 Newton-meters.

Figure 5.10 Connecting the Tip to the Horn

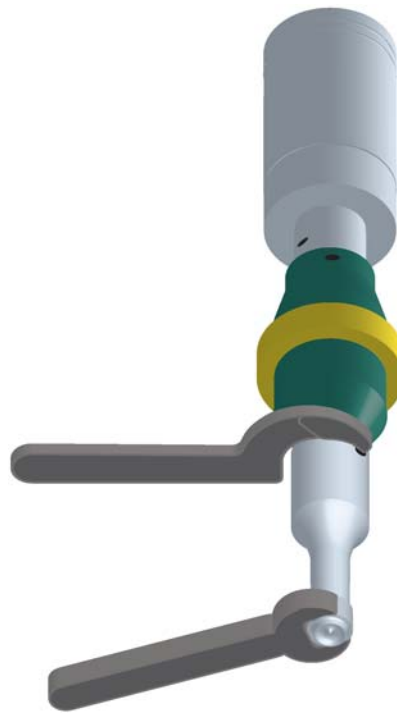

5.4.3 Horn Amplitudes

Use the following charts to determine the correct system settings for the horn in use.

Table 5.6 Suggested Amplitude Values for Various Horns

Horn EDP Number	Description	Amplitude Control Settings		
		10%	50%	100%
101-147-037	1/2" Diameter Tapped Stepped Disruptor	21.0* 0.0008"	76.0* 0.0029"	145.0* 0.0057"
101-147-042	1/2" Diameter Solid Catenoidal Disruptor	21.0* 0.0008"	76.0* 0.0029"	145.0* 0.0057"
101-147-041	1/2" Diameter Solid Exponential Disruptor	10.0* 0.0004"	34.0* 0.0013	65.0* 0.0026"
101-147-039	3/8" Diameter Solid Stepped Disruptor	36.0* 0.0014"	125.0* 0.0049"	240.0* 0.0094"
101-147-043	3/4" Diameter Solid Stepped Disruptor	9.5* 0.0004"	33.0* 0.0013"	63.0* 0.0025"
101-147-035	3/4" Diameter Solid High Gain Disruptor	19.0* 0.0007"	68.5* 0.0027"	130.0* 0.0051"
101-147-044	1.0" Diameter Solid Stepped Disruptor	6.3* 0.0002"	21.5* 0.0008"	40.5* 0.0016"

*All measurements in microns unless otherwise specified.

Table 5.7 Approximate Microtip Amplitudes

Horn EDP Number	Description	Amplitude Control Settings		
		10%	40%	70%
101-148-062	1/8" Diameter Tapered	116.0* 0.0046"	306.0* 0.0122"	494.0* 0.0194"
101-148-069	3/16" Diameter Tapered	59.5* 0.0023	183.0* 0.0072"	302.0* 0.0119"
101-148-070	1/4" Diameter Tapered	59.5* 0.0023"	151.0* 0.0059	247.0* 0.0097"
101-063-212	Double Step	64.0* 0.0025"	173.8* 0.0068"	274.0* 0.0108"

*All measurements in microns unless otherwise specified.

5.5 Input Power Requirements

The input power requirements for the Sonifier power supply are:

- 100-120 VAC, 50/60 Hz (North American/Japan model)
- 200-240 VAC, 50/60 Hz (all 240 V models)

The Sonifier power supply is equipped with an IEC-type power cord connector. The unit requires a single-phase, three-wire, 50/60 Hz power source.

WARNING	High Voltage Hazard
	To prevent the possibility of electrical shock, always plug the Sonifier power supply unit into a grounded power source.

The system is fuse-protected with a replaceable glass fuse, 5x20mm, slow-blow type (refer to the data tag on the system). This fuse should never blow under normal operating conditions. The fuse holder is found on the rear of the unit, as part of the IEC power connector.

5.6 Electrical Connections to Equipment

All of the connections to the Sonifier power supply are made to the rear of the unit using industry-standard connectors. Refer to [2.3 Back Panel Connections](#) for connector locations. See [Appendix B: Parts Lists](#) and [Appendix C: Accessories](#) for standard and accessory part numbers.

5.6.1 Power Cord

North American units are shipped with a 3-conductor 117 Volt cordset (NEMA 5-15P to IEC jack). It connects to an IEC-type connector on the rear of the unit. The plug end connects to your main voltage receptacle, which should be properly fused (depending on your site requirements). It requires a conventional NEMA 5-15R receptacle for installation.

Export CE units are shipped with a standard Harmonized European cordset (having an IEC-type jack and Europlug).

Export non-CE units are shipped with a UL[®]/CSA[®] cordset and a NEMA 6-15 plug.

Export non-CE units for China are shipped with a line cord and labeling specific to China's requirements.

NOTICE

If your cordset does not match your main power receptacle, verify that you have the correct voltage available. Do not connect the system if the voltage rating of the unit is incorrect for your location, as this can damage the unit.

5.6.2 Temperature Probe Connection

The temperature probe (optional) is connected to the Sonifier power supply using a 1/4 inch RCA-type phone jack connector. The temperature probe that is specified matches properly, and is the only temperature device for use with the Sonifier system. All temperature related settings and measurements are only available when the temperature probe is connected.

5.6.3 User I/O Connection

The Sonifier power supply is equipped with a standard 9-pin D-Sub to allow you to design and connect your own custom interface for controlling the unit. The User I/O interface can be useful when you need to activate the Sonifier system remotely, for example, when the operator must start and stop the unit from another room for safety reasons.

Figure 5.11User I/O

Pin	Function	Signal Type	Signal Range	Values
1	Alarm/Error Reset	Input	0 V to 24 V ±10%	Apply 0 V to reset alarms/errors
2	Start/Stop		0 V to 24 V ±10%	Apply +24 VDC to start/stop the cycle
3	Sonics On	Output	0 V to 24 V ±10% 20 mA	0 V indicates the function is active
	Cycle Running			See Register 19 in 6.4 System Configuration Registers
	End of Cycle Pulse			
4	Alarm/Error		0 V to 24 V ±10% 20 mA	0 V indicates an alarm/error occurred
5	Ready		0 V to 24 V ±10% 20 mA	0 V indicates the system is ready
6	+24V Source		0 V to 24 V ±10% 125 mA Max	+24 V Source from power supply
7	+24V Return	I/O Signal Return	0 V Ground	Return for all pins
8	External Seek+	Input	0 V to 24 V ±10%	Apply +24 VDC to perform a seek
9	External Seek-			

5.7 Guards and Safety Equipment

Although the Sonifier system operates outside the normal range of human hearing, some applications can create audible noise above 85 dB. If an uncomfortable level of noise is present, the operator should wear ear protection for safe operation.

Appropriate eye protection should be worn when operating the Sonifier system to prevent possible splash injury originating in the solution.

The ultrasonic horn can cause injury and/or equipment damage during operation. To avoid injury or accident, never touch the ultrasonic horn while the system is turned on, and do not allow the horn to come in contact with solid vessels or supports.

The User I/O may be used to remotely control the system. If this is the case, you must design in whatever safety precautions are appropriate to your User I/O circuit design to prevent unexpected start-up, which can cause personal injury and can cause equipment damage.

5.8 Ultrasonic Test

NOTICE

To perform an ultrasonic test using a handheld converter, see [Appendix D: Handheld Converter](#).

The Test key on the front panel of the Sonifier power supply is used to verify that the unit is functioning (providing ultrasonic energy to the converter and horn).

Before testing the Sonifier system, always make sure that the horn is not touching anything. The system also performs several self-tests when it is first turned on.

Table 5.8 Ultrasonic Test

Step	Do this...	To obtain this result
1	Set up the Sonifier system following the instructions in this manual. If no horn or microtip is currently installed, mount a horn or microtip to the converter.	Prepare the Sonifier system to operate, if it was not previously assembled.
2	After you have connected the converter/horn or converter/microtip to the converter cable and verified all other connections are as desired, turn the unit On, and observe the self-test displays.	Verify that the system passes all its self-tests, observing that there are no error messages on the front panel display. The Sonifier system advances to the ready (rdy) mode and shows 'rdy' on the display (see 2.2 Front Panel Controls and Indicators).
3	Adjust the Amplitude control to approximately 50% (observe the value on the front panel display). See Chapter 6: Operation to adjust the amplitude.	Ensures that ultrasonic energy will be at a mid-range value, and will not cause damage if you were using a microtip (which must be used at less than 70%).
4	Verify that the horn is not touching anything. Press the Test key on the front panel. Observe the front panel display.	Verifies the ultrasonic output of the system. You may hear a soft, high-pitched sound. The display will show the output power value. The test will run for 2 seconds, then stop.
5	If no alarms occurred during the Test, you may either proceed with using the system or turn the unit off. If an error occurs, see 7.4 Alarms/Errors for more information.	Verification that the Sonifier system is operating and is ready to be set up for your experiment or processing needs.

NOTICE

See [7.3 Troubleshooting Chart](#) if you have difficulties performing the above steps.

Chapter 6: Operation

6.1	Front Panel Controls	50
6.2	Control Modes	51
6.3	Results	54
6.4	System Configuration Registers	55
6.5	Setup Sequence	59
6.6	Save/Load Control Setup	92

6.1 Front Panel Controls

6.1.1 User Interface

The user interface on the front panel of the Sonifier power supply allows you to enter parameters for both system setup and operation of the unit.

Figure 6.1 Sonifier Power Supply User Interface



NOTICE

Do not use a sharp or pointed object to press the front panel controls. The soft-touch membrane front panel can be permanently damaged.

NOTICE

Temperature modes will only be displayed if a temperature probe is connected.

NOTICE

Entering an illegal value will generate 3 beeps. The system will not accept out-of-range parameters. (See [7.4 Alarms/Errors](#) for further details).

NOTICE

You can return to the ready screen when modifying control settings by pressing the ESC key. Any setting modifications that were applied before, by pressing the enter key, will be saved.

6.2 Control Modes

You can control the way in which ultrasonics are applied to your sample or liquid by setting the unit to operate in one of several different modes. You determine the mode and specify operating parameters for your ultrasonic cycle. The standard control modes are described below:

6.2.1 Primary Control Modes

Table 6.1 Continuous Sonics Modes

Control Mode		Description
Continuous Sonics	Time	Continuous sonics are run, at a set constant amplitude, for a set time.
	Energy	Continuous sonics are run, at a set constant amplitude, until a set amount of energy (in joules) is delivered by the Sonifier power supply.
	Infinite	Continuous sonics are run, at a set constant amplitude, for an indefinite time. Sonics will continue to run until stopped by the user.

Table 6.2 Pulsed Sonics Modes

Control Mode		Description
Pulsed Sonics	Time	Pulsed sonics are run, at a set constant amplitude, until the sonics bursts or pulses add up to the set time (Total On Time). In this mode sonics will pulse on and off according to the ON Time and OFF Time settings.
	Energy	Pulsed sonics are run, at a set constant amplitude, until a set amount of energy (joules) is delivered by the Sonifier system. In this mode sonics will pulse on and off according to the ON Energy and OFF Time settings.
	Infinite	Pulsed sonics are run, at a set constant amplitude, for an indefinite time. In this mode sonics will pulse on and off according to either the ON Energy or ON Time, and OFF Time settings. Sonics will continue to run until stopped by the user.

6.2.2 Temperature Control Modes

Table 6.3 Maximum Temperature Modes

Control Mode		Description
Maximum Temperature	Continuous Sonics	Continuous sonics are run, at a set constant amplitude, until a set Maximum Temperature is measured by the temperature probe.
	Pulsed Sonics (Time or Energy)	Pulsed sonics are run, at a set constant amplitude, until a set Maximum Temperature is measured by the temperature probe. In this mode sonics will pulse on and off according to either the ON Energy or ON Time, and OFF Time settings.

Table 6.4 Temperature Limit Modes

Control Mode		Description
Temperature Limit	Continuous Sonics - Time	Continuous sonics are run, at a set constant amplitude, for a set time. If the temperature measured by the temperature probe equals or exceeds a set Maximum Temperature, sonics and the time counter will pause until the measured temperature falls 3°F (or 2°C) below the Maximum Temperature setting. At that instant the sonics and the time counter will resume.
	Continuous Sonics - Energy	Continuous sonics are run, at a set constant amplitude, until a set amount of energy (in joules) is delivered by the Sonifier system. If the temperature measured by the temperature probe equals or exceeds a set Maximum Temperature, sonics and the energy counter will pause until the measured temperature falls 3°F (or 2°C) below the Maximum Temperature setting. At that instant the sonics and the energy counter will resume.
	Pulsed Sonics (Time or Energy)	Pulsed sonics are run, at a set constant amplitude, for a set time. In this mode sonics will pulse on and off according to either the ON Energy or ON Time, and OFF Time settings. If the temperature measured by the temperature probe equals or exceeds a set Maximum Temperature, sonics and the Total ON (Time) or Total ON (Energy) counter will pause until the measured temperature falls 3°F (or 2°C) below the Maximum Temperature setting. At that instant the sonics and the Total ON (Time) or Total ON (Energy) counter will resume.

Table 6.5 Pulse Temperature Modes

Control Mode		Description
Pulse Temperature	Continuous Sonics - Time	Continuous sonics are run, at a set constant amplitude, for a set time. If the temperature measured by the temperature probe equals or exceeds a set Pulse Temperature, sonics will begin pulsing (at an automatically calculated rate) to maintain the sample or liquid at the pulse temperature setting. The time counter will only continue to increment during the time that ultrasonics is on. So that, if pulsing occurs during the cycle the actual cycle time will exceed the set time. If the temperature measured by the temperature probe falls below the set Pulse Temperature, pulsing will stop and continuous sonics will resume. If the temperature measured by the temperature probe equals or exceeds a set Maximum Temperature, sonics and the time counter will pause until the measured temperature falls 3°F (or 2°C) below the Maximum Temperature setting. At that instant the sonics will continue to pulse at an automatically calculated rate and the time counter will resume.
	Continuous Sonics - Energy	Continuous sonics are run, at a set constant amplitude, until a set amount of energy (in joules) is delivered by the Sonifier system. If the temperature measured by the temperature probe equals or exceeds a set Pulse Temperature, sonics will begin pulsing (at an automatically calculated rate) to maintain the sample or liquid at the pulse temperature setting. If the temperature measured by the temperature probe falls below the set Pulse Temperature, pulsing will stop and continuous sonics will run. If the temperature measured by the temperature probe equals or exceeds a set Maximum Temperature, sonics and the energy counter will pause until the measured temperature falls 3°F (or 2°C) below the Maximum Temperature setting. At that instant the sonics will continue to pulse at an automatically calculated rate and the energy counter will resume.
	Pulsed Sonics (Time or Energy)	Pulsed sonics are run, at a set constant amplitude, for a set time. In this mode sonics will pulse on and off according to the either the ON Time or ON Energy, and OFF Time settings. In this mode sonics will begin to pulse on and off according to the either the ON Time or ON Energy, and OFF Time settings. If the temperature measured by the temperature probe equals or exceeds a set Pulse Temperature, sonics pulse will be adjusted (at an automatically calculated rate) to maintain the sample or liquid at the pulse temperature setting. If the temperature measured by the temperature probe falls below the set Pulse Temperature, automatic adjustment of pulse rate will stop and sonics will continue to run with the original preset pulse settings. If the temperature measured by the temperature probe equals or exceeds a set Maximum Temperature, sonics and the Total ON (Time) or Total O (Energy) counter will pause until the measured temperature falls 3°F (or 2°C) below the Maximum Temperature setting. At that instant the sonics will continue to pulse at an automatically calculated rate and the Total ON (Time) or Total ON (Energy) counter will resume.

6.3 Results

After a cycle has been run, the results can be viewed by pressing the Left/Right keys while on the rdy screen.

Table 6.6 Results for Continuous Sonics - Time Mode (Example)

Item	Description
1	After a cycle has been run, you will be returned to the rdy screen.
2	Press the Right key to display the Total Time.
3	Press the Right key to display the Total Energy.
4	Press the Right key to display the Amplitude.
5	Press the Right key to display the Peak Power.
6	Press the Right key to display the Maximum Temperature. NOTICE Temperature results will only be displayed if a temperature probe is connected.
7	Press the Right key display the End Temperature.

Figure 6.2 Results for Continuous Sonics - Time Mode (Example)

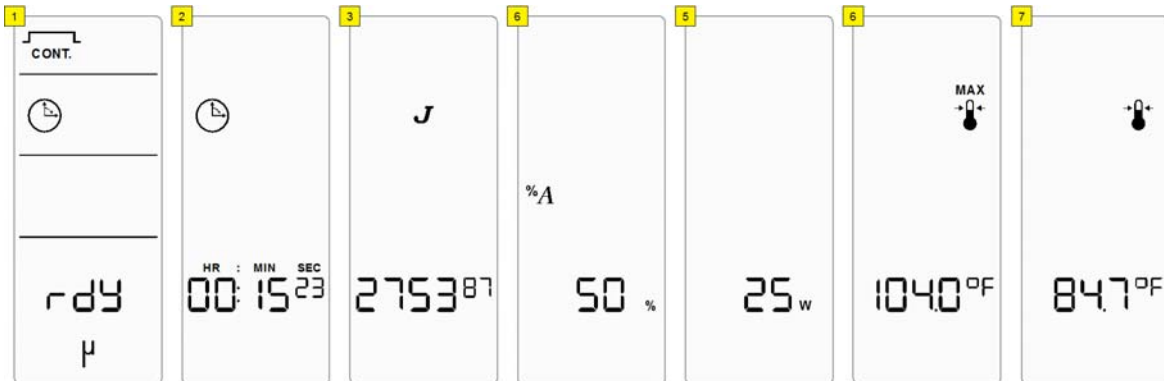

6.4 System Configuration Registers

To access and modify the system configuration registers:

Table 6.7 Modify Registers

Step	Action
1	Press the Enter and Preset keys simultaneously while on rdy screen.
2	Use the Up and Down keys to select the register to modify, then press the Enter key to confirm the selection.
3	Use the Up and Down keys to set the desired parameter, then press enter to confirm the entered value.
4	Press the ESC key to return to the rdy screen.

The table below shows the register number along the description and parameters.

Table 6.8 System Configuration Register Settings

Register	Description	Parameters
1	<p>Software Version</p> <p>Shows the current software version installed on the unit.</p>	N/A
2	<p>Panel Trigger</p> <p>In OFF position, the user must control the Start/Stop function through the 9-pin D-Shell connector on the back of the Sonifier power supply enclosure. This mode disables the Start/Stop key from starting a cycle, but will always permit it stopping a cycle. Test key is not disabled.</p> <p>In ON position, the Start/Stop function is controlled at the front panel of the unit only. The Start/Stop function is disabled at the 9-pin D-shell connector at the back of the Sonifier power supply enclosure.</p>	<p>0 (OFF)</p> <p>1 (ON) Default</p>
3	<p>Pulse Start</p> <p>In ON position the user must press the Start/Stop key for a minimum duration of 10 ms to initiate a cycle. After 10 ms the Start/Stop key can be released allowing the system to continue through the intended cycle. Releasing and pressing the Start/Stop key again will abort the current process cycle.</p> <p>In OFF position the user must continue to hold the Start/Stop key throughout the duration of the process cycle. If the Start/Stop key is released during a cycle then the cycle is aborted.</p> <p>NOTICE</p> <p>In both modes the Start/Stop key must be released before the next cycle can be started.</p>	<p>0 (OFF)</p> <p>1 (ON) Default</p>

Table 6.8 System Configuration Register Settings

Register	Description	Parameters
4	<p>Auto Reset</p> <p>In OFF position the alarm/error must be reset either by the front panel Reset key or through the external 9-pin connector. The controls will not function and no parameters can be changed, the cycle result when the alarm/error occurred will be shown until the Reset signal has been given.</p> <p>In ON position a Reset signal is not required. The Start signal can be given directly after the alarm/error has occurred. After the alarm/error has occurred the operator can access all functions of the Sonifier system. The overload will need to be cleared before making any changes.</p>	<p>0 (OFF) Default</p> <p>1 (ON)</p>
5	<p>End of Total Cycle Beeper (One Beep)</p>	<p>0 (OFF)</p> <p>1 (ON) Default</p>
6	<p>Alarm/Error Beeper (Three Beeps)</p> <p>The beeper will sound if an alarm/error is encountered.</p>	<p>0 (OFF)</p> <p>1 (ON) Default</p>
8	<p>Configuration Lock</p> <p>In the ON position system settings are locked. Access to ultrasonic cycle parameter modification; system configuration registers; and saving/loading cycle configurations is no longer permitted.</p> <p>In the OFF position access is unrestricted to all parameters, system settings, and cycle configurations.</p> <p>NOTICE</p> <p>To turn off Configuration Lock, power down the Sonifier power supply, then press and hold down the Enter and Preset keys simultaneously while turning on the unit to access the register settings.</p>	<p>0 (OFF) Default</p> <p>1 (ON)</p>
9	<p>Seek @ Power Up</p> <p>In the OFF position, the seek @ power up will not occur.</p> <p>In the ON position, the seek @ power up will occur. When the system performs a Seek function the ultrasonic stack is run at low amplitude to tune to the ultrasonic converter's operating frequency.</p>	<p>0 (OFF)</p> <p>1 (ON) Default</p>

Table 6.8 System Configuration Register Settings

Register	Description	Parameters
10	<p>Timeout</p> <p>Set cycle timeout.</p> <p>NOTICE</p> <p>This timeout is used to prevent cycles from running indefinitely without stopping. Cycle parameter settings and physical setup must enable the cycle to finish before this time elapses.</p>	<p>HH:MM:SS</p> <p>02:00:00 (Default)</p>
15	<p>Temperature Units</p> <p>Set the temperature units in Fahrenheit or Celsius.</p>	<p>0 (°C)</p> <p>1 (°F) Default</p>
16	<p>System Restore</p> <p>When setting the register to ON, all register settings and the current cycle configuration parameters will be set to default values. All stored cycle configurations will not be affected.</p>	<p>0 (OFF) Default</p> <p>1 (ON)</p>
17	<p>Handheld Amplitude Limit</p> <p>When set to ON, amplitude is automatically limited to 70% when using a handheld converter.</p> <p>To override the automatic amplitude limit, set register to OFF.</p> <p>NOTICE</p> <p>Operation above 70% amplitude is not recommended by Branson when using microtips.</p>	<p>0 (OFF)</p> <p>1 (ON) Default</p>
18	<p>Temperature Calibration</p> <p>Use this register to calibrate temperature readings using a reference instrument. After setting up the temperature probe and your reference instrument to ensure both are at the same temperature, access this register and adjust the displayed temperature using the up and down arrows. To verify proper adjustment exit and re-enter this register and confirm both instruments display the same temperature, if not readjust and repeat.</p>	<p>Temperature at the moment the register is accessed will be displayed.</p>

Table 6.8 System Configuration Register Settings

Register	Description	Parameters
19	<p>Cycle Status Signal Configure the behavior of the cycle status signal (pin 3). This pin can be configured to function as:</p> <p>Sonics On Output will be active during a cycle only while sonics are running.</p> <p>Cycle Running Output will be active during the complete cycle.</p> <p>End of Cycle Pulse Output will generate a 250 ms pulse at the end of the cycle.</p>	<p>0 (Sonics On)</p> <p>1 (Cycle Running) Default</p> <p>2 (End of Cycle Pulse)</p>

6.5 Setup Sequence

6.5.1 Continuous Sonics - Time Mode Parameters

Table 6.9 Continuous Sonics - Time Mode Parameters

Parameter	Default	Max. Value	Min. Value
Amplitude	50%	100% (70% with microtip)	10%
Time	0 hrs 1 min 0 s	99 hrs 59 min 59 s	00 hrs 00 min 01 s*

*If set to 00:00:00 cycle will run as Continuous Sonics - Infinite Mode. See [6.5.3 Continuous Sonics - Infinite Mode](#) for more information.

Table 6.10 Continuous Sonics - Time Mode Setup Sequence

Step	Action
1	Turn on power, wait for the LCD to show rdy and current mode. Press the Up, Down, or Enter key once to get into sonics mode selection.
2	Use the Left and Right keys to select Continuous mode, then press the Enter key to confirm the selection.
3	Use the Left and Right keys to select Time mode, then press the Enter key to confirm the selection.
4	Use the Navigation keys to set the desired Time parameter, then press the Enter key to confirm the entered value.
5	Use the Navigation keys to set the Max Temperature to off, then press the Enter key to confirm the setting. NOTICE Temperature control parameters will only be displayed if a temperature probe is connected.
6	Use the Navigation keys to set the desired Amplitude parameter, then press the Enter key to confirm the entered value.
7	You will be returned to the rdy screen.

Figure 6.3 Continuous Sonics - Time Mode

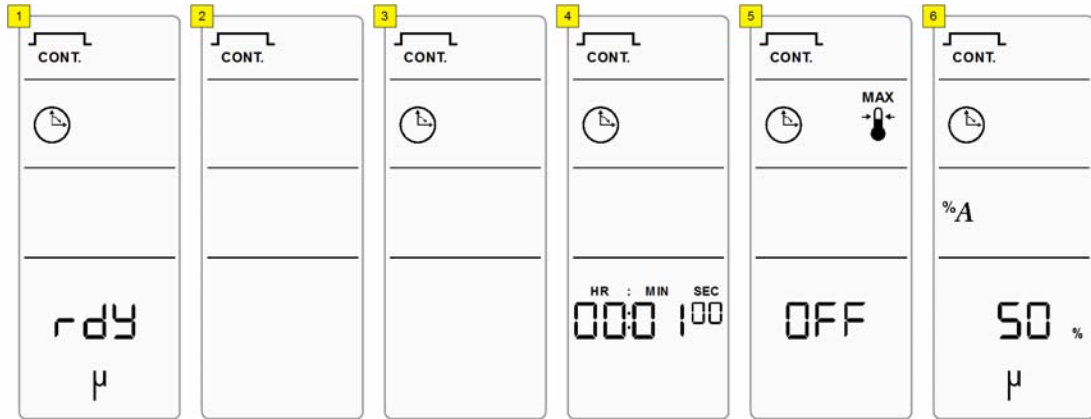

6.5.2 Continuous Sonics - Energy Mode

Table 6.11 Continuous Sonics - Energy Mode Parameters

Parameter	Default	Max. Value	Min. Value
Amplitude	50%	100% (70% with microtip)	10%
Energy	1 J	999999 J	1 J

Table 6.12 Continuous Sonics - Energy Mode Setup Sequence

Step	Action
1	Turn on power, wait for the LCD to show rdy and current mode. Press the Up, Down, or Enter key once to get into sonics mode selection.
2	Use the Left and Right keys to select Continuous mode, then press the Enter key to confirm the selection.
3	Use the Left and Right keys to select Energy mode, then press the Enter key to confirm the selection.
4	Use the Navigation keys to set the desired Energy parameter, then press the Enter key to confirm the entered value.
5	Use the Navigation keys to set the Max Temperature to off, then press the Enter key to confirm the setting. NOTICE Temperature control parameters will only be displayed if a temperature probe is connected.
6	Use the Navigation keys to set the desired Amplitude parameter, then press the Enter key to confirm the entered value.
7	You will be returned to the rdy screen.

Figure 6.4 Continuous Sonics - Energy Mode

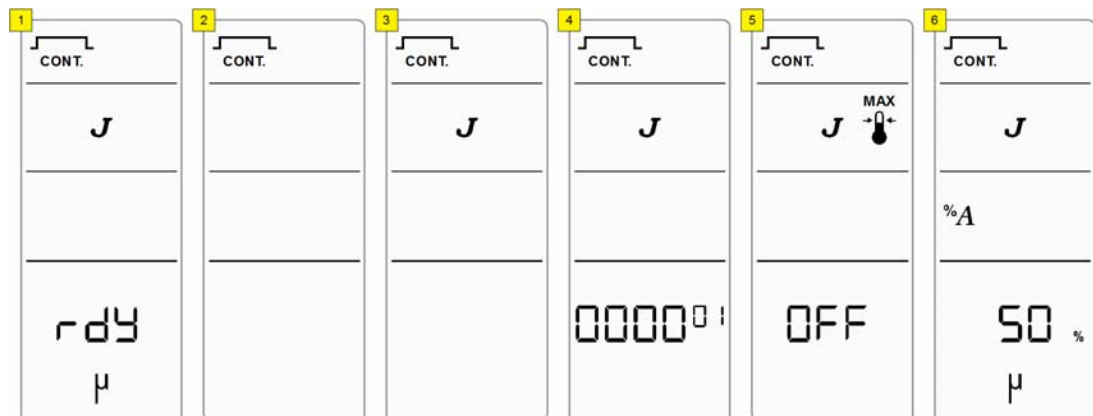

6.5.3 Continuous Sonics - Infinite Mode

Table 6.13 Continuous Sonics - Infinite Mode Parameters

Parameter	Default	Max. Value	Min. Value
Amplitude	50%	100% (70% with microtip)	10%

Table 6.14 Continuous Sonics - Infinite Mode Setup Sequence

Step	Action
1	Turn on power, wait for the LCD to show rdy and current mode. Press the Up, Down, or Enter key once to get into sonics mode selection
2	Use the Left and Right keys to select Continuous mode, then press the Enter key to confirm the selection
3	Use the Left and Right keys to select Time mode, then press the Enter key to confirm the selection
4	Use the Navigation keys to set the Time parameter to 00:00:00, display will change to OFF. Press the enter key to confirm
5	Use the Navigation keys to set the Max Temperature to off, then press the Enter key to confirm the setting NOTICE Temperature control parameters will only be displayed if a temperature probe is connected
6	Use the Navigation keys to set the desired Amplitude parameter, then press the Enter key to confirm the entered value
7	You will be returned to the rdy screen

Figure 6.5 Continuous Sonics - Infinite Mode

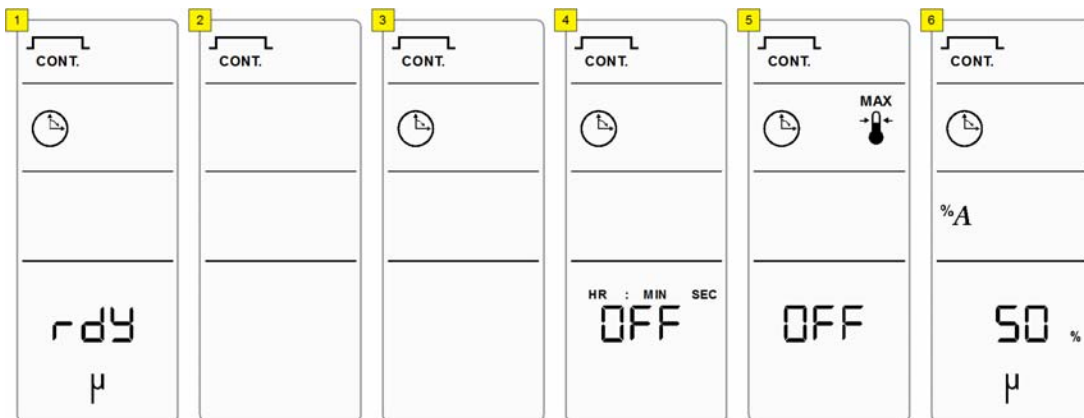

6.5.4 Pulsed Sonics - Time Mode

Table 6.15 Pulsed Sonics - Time Mode Parameters

Parameter	Default	Max. Value	Min. Value
Amplitude	50%	100% (70% with microtip)	10%
Off Time	1 hs (10 ms)	59 m 59 s 99 hs (990 ms)	1 hs (10 ms)
On Time	1 hs (10 ms)	59 m 59 s 99 hs (990 ms)	1 hs (10 ms)
Total On (Time)	0 hrs 1 min 0 s	99 h 59 m 59 s	00 hrs 00 min 01 s*

*If set to 00:00:00 cycle will run as Pulsed Sonics - Infinite Mode (Time). See [6.5.6 Pulsed Sonics - Infinite Mode \(Time\)](#) for more information.

Table 6.16 Pulsed Sonics - Time Mode Setup Sequence

Step	Action
1	Turn on power, wait for the LCD to show rdy and current mode. Press the Up, Down, or Enter key once to get into sonics mode selection.
2	Use the Left and Right keys to select Pulsed mode, then press the Enter key to confirm the selection.
3	Use the Left and Right keys to select Time mode, then press the Enter key to confirm the selection.
4	Use the Navigation keys to set the desired On Time parameter, then press the Enter key to confirm the entered value.
5	Use the Navigation keys to set the desired Off Time parameter, then press the Enter key to confirm the entered value.
6	Use the Navigation keys to set the desired Total On Time parameter, then press the Enter key to confirm the setting.
7	Use the Navigation keys to set the Max Temperature to off, then press the Enter key to confirm the setting. NOTICE Temperature control parameters will only be displayed if a temperature probe is connected.
8	Use the Navigation keys to set the desired Amplitude parameter, then press the Enter key to confirm the entered value.
9	You will be returned to the rdy screen.

Figure 6.6 Pulsed Sonics - Time Mode

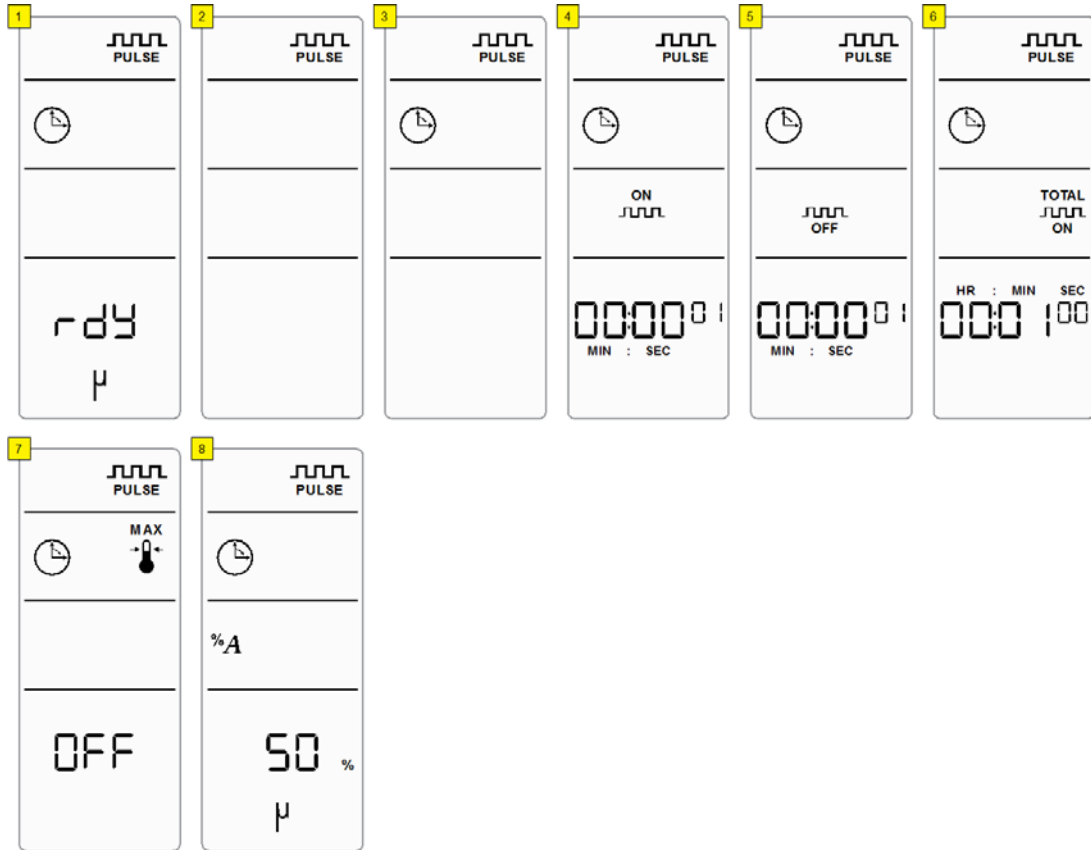

6.5.5 Pulsed Sonics - Energy Mode

Table 6.17 Pulsed Sonics - Energy Mode Parameters

Parameter	Default	Max. Value	Min. Value
Amplitude	50%	100% (70% with microtip)	10%
Off Time	1 hs (10 ms)	59 m 59 s 99 hs (990 ms)	1 hs (10 ms)
On Energy	1 J	9999 J	1 J
Total On (Energy)	1 J	999999 J	1 J*

*If set to 0 J cycle will run as Pulsed Sonics - Infinite Mode (Energy). See [6.5.7 Pulsed Sonics - Infinite Mode \(Energy\)](#) for more information.

Table 6.18 Pulsed Sonics - Energy Mode Setup Sequence

Step	Action
1	Turn on power, wait for the LCD to show rdy and current mode. Press the Up, Down, or Enter key once to get into sonics mode selection.
2	Use the Left and Right keys to select Pulsed mode, then press the Enter key to confirm the selection.
3	Use the Left and Right keys to select Energy mode, then press the Enter key to confirm the selection.
4	Use the Navigation keys to set the desired On Energy parameter, then press the Enter key to confirm the entered value.
5	Use the Navigation keys to set the desired Off Time parameter, then press the Enter key to confirm the entered value.
6	Use the Navigation keys to set the desired Total On Energy parameter, then press the Enter key to confirm the setting.
7	Use the Navigation keys to set the Max Temperature to off, then press the Enter key to confirm the setting. NOTICE Temperature control parameters will only be displayed if a temperature probe is connected.
8	Use the Navigation keys to set the desired Amplitude parameter, then press the Enter key to confirm the entered value.
9	You will be returned to the rdy screen.

Figure 6.7 Pulsed Sonics - Energy Mode

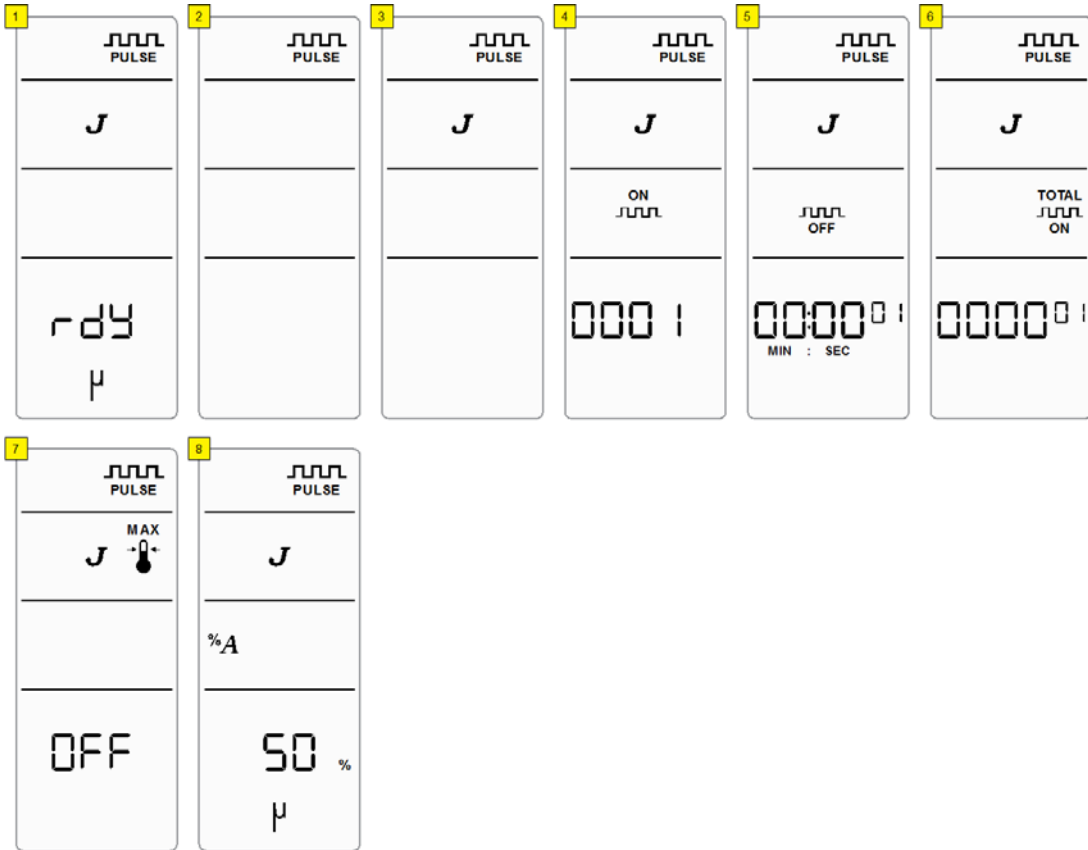

6.5.6 Pulsed Sonics - Infinite Mode (Time)

Table 6.19 Pulsed Sonics - Infinite Mode (Time) Parameters

Parameter	Default	Max. Value	Min. Value
Amplitude	50%	100% (70% with microtip)	10%
Off Time	1 hs (10 ms)	59 m 59 s 99 hs (990 ms)	1 hs (10 ms)
On Time	1 hs (10 ms)	59 m 59 s 99 hs (990 ms)	1 hs (10 ms)

Table 6.20 Pulsed Sonics - Infinite Mode (Time) Setup Sequence

Step	Action
1	Turn on power, wait for the LCD to show rdy and current mode. Press the Up, Down, or Enter key once to get into sonics mode selection.
2	Use the Left and Right keys to select Pulsed mode, then press the Enter key to confirm the selection.
3	Use the Left and Right keys to select Time mode, then press the Enter key to confirm the selection.
4	Use the Navigation keys to set the desired On Time parameter, then press the Enter key to confirm the entered value.
5	Use the Navigation keys to set the desired Off Time parameter, then press the Enter key to confirm the entered value.
6	Use the Navigation keys to set the Time to 00:00 00, display will change to OFF. Press the enter key to confirm.
7	Use the Navigation keys to set the Max Temperature to off, then press the Enter key to confirm the setting. NOTICE Temperature control parameters will only be displayed if a temperature probe is connected.
8	Use the Navigation keys to set the desired Amplitude parameter, then press the Enter key to confirm the entered value.
9	You will be returned to the rdy screen.

Figure 6.8 Pulsed Sonics - Infinite Mode (Time)

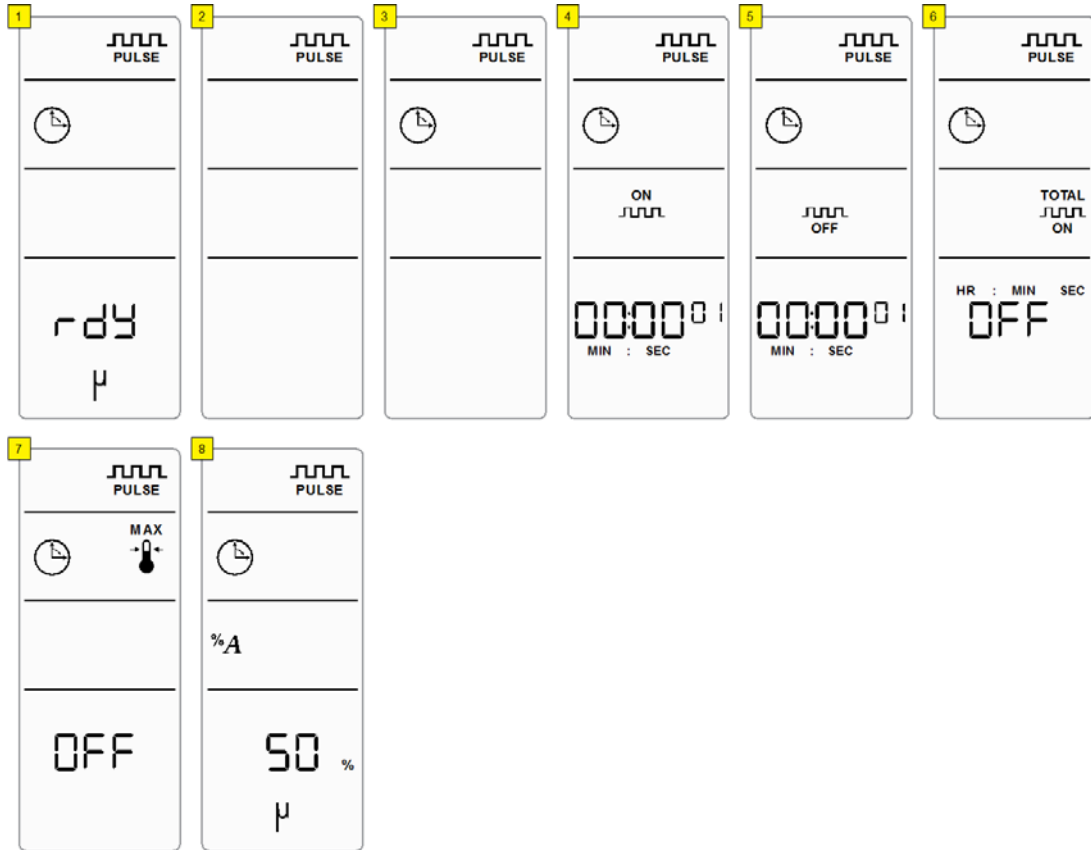

6.5.7 Pulsed Sonics - Infinite Mode (Energy)

Table 6.21 Pulsed Sonics - Infinite Mode (Energy) Parameters

Parameter	Default	Max. Value	Min. Value
Amplitude	50%	100% (70% with microtip)	10%
Off Time	1 hs (10 ms)	59 m 59 s 99 hs (990 ms)	1 hs (10 ms)
On Energy	1 J	9999 J	1 J

Table 6.22 Pulsed Sonics - Infinite Mode (Energy) Setup Sequence

Step	Action
1	Turn on power, wait for the LCD to show rdy and current mode. Press the Up, Down, or Enter key once to get into sonics mode selection.
2	Use the Left and Right keys to select Pulsed mode, then press the Enter key to confirm the selection.
3	Use the Left and Right keys to select Energy mode, then press the Enter key to confirm the selection.
4	Use the Navigation keys to set the desired On Energy parameter, then press the Enter key to confirm the entered value.
5	Use the Navigation keys to set the desired Off Time parameter, then press the Enter key to confirm the entered value.
6	Use the Navigation keys to set the Total On Energy to 0 J, display will change to OFF. Press the enter key to confirm.
7	Use the Navigation keys to set the Max Temperature to off, then press the Enter key to confirm the setting. NOTICE Temperature control parameters will only be displayed if a temperature probe is connected.
8	Use the Navigation keys to set the desired Amplitude parameter, then press the Enter key to confirm the entered value.
9	You will be returned to the rdy screen.

Figure 6.9 Pulsed Sonics - Infinite Mode (Energy)

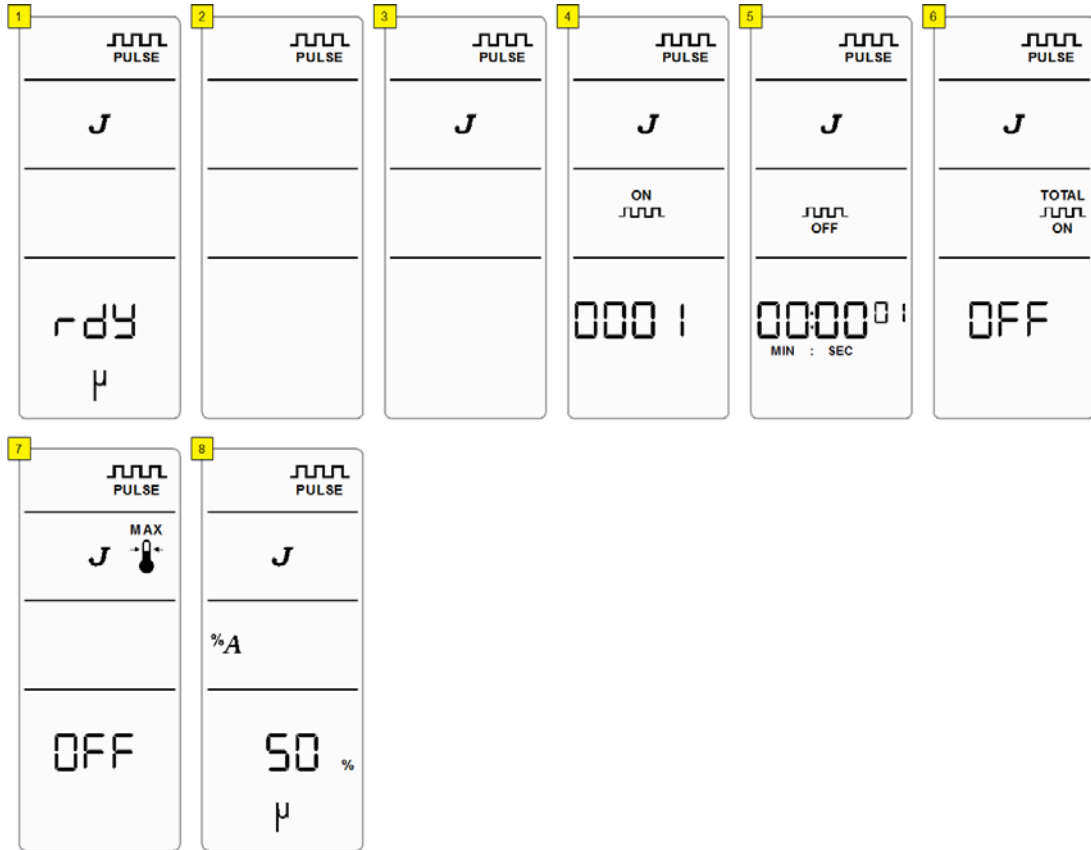

6.5.8 Maximum Temperature - Continuous Sonics Mode

NOTICE

Maximum Temperature Mode will only be available if a temperature probe is connected.

Table 6.23 Maximum Temperature - Continuous Sonics Mode Parameters

Parameter	Default	Max. Value	Min. Value
Amplitude	50%	100% (70% with microtip)	10%
Max. Temperature	104.0°F (40.0°C)	212.0°F (100.0°C)	32.0°F (0.0°C)

Table 6.24 Maximum Temperature - Continuous Sonics Mode Setup Sequence

Step	Action
1	Turn on power, wait for the LCD to show rdy and current mode. Press the Up, Down, or Enter key once to get into sonics mode selection.
2	Use the Left and Right keys to select Continuous mode, then press the Enter key to confirm the selection.
3	Use the Left and Right keys to select Maximum Temperature mode, then press the Enter key to confirm the selection.
4	Use the Navigation keys to set the desired Max Temperature parameter, then press the Enter key to confirm the entered value.
5	Use the Navigation keys to set the desired Amplitude parameter, then press the Enter key to confirm the entered value.
6	You will be returned to the rdy screen.

Figure 6.10 Maximum Temperature - Continuous Sonics Mode

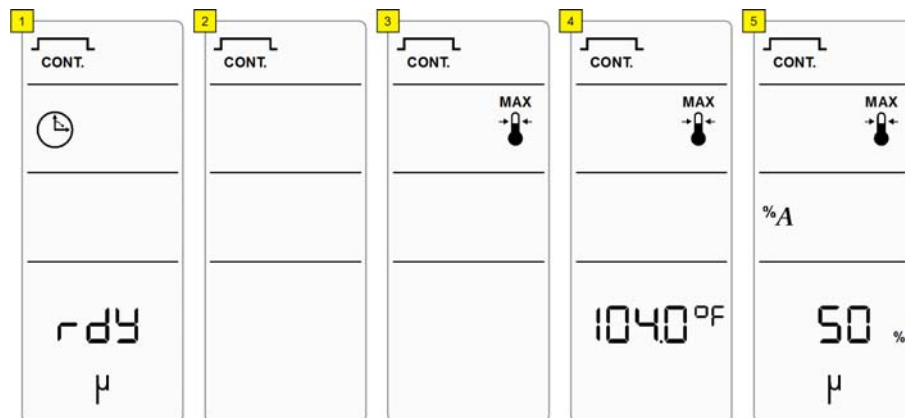

6.5.9 Maximum Temperature - Pulsed Sonics Mode (Time)

NOTICE

Maximum Temperature Mode will only be available if a temperature probe is connected.

Table 6.25 Maximum Temperature - Pulsed Sonics Mode (Time) Parameters

Parameter	Default	Max. Value	Min. Value
Amplitude	50%	100% (70% with microtip)	10%
Max. Temperature	104.0°F (40.0°C)	212.0°F (100.0°C)	32.0°F (0.0°C)
Off Time	1 hs (10 ms)	59 m 59 s 99 hs (990 ms)	1 hs (10 ms)
On Time	1 hs (10 ms)	59 m 59 s 99 hs (990 ms)	1 hs (10 ms)

Table 6.26 Maximum Temperature - Pulsed Sonics Mode (Time) Setup Sequence

Step	Action
1	Turn on power, wait for the LCD to show rdy and current mode. Press the Up, Down, or Enter key once to get into sonics mode selection.
2	Use the Left and Right keys to select Pulsed mode, then press the Enter key to confirm the selection.
3	Use the Left and Right keys to select Maximum Temperature mode, then press the Enter key to confirm the selection.
4	Use the Navigation keys to set the desired Maximum Temperature parameter, then press the Enter key to confirm the entered value.
5	Use the Left and Right keys to select Time mode, then press the Enter key to confirm the selection.
6	Use the Navigation keys to set the desired On Time parameter, then press the Enter key to confirm the entered value.
7	Use the Navigation keys to set the desired Off Time parameter, then press the Enter key to confirm the entered value.
8	Use the Navigation keys to set the desired Amplitude parameter, then press the Enter key to confirm the entered value.
9	You will be returned to the rdy screen.

Figure 6.11 Maximum Temperature - Pulsed Sonics Mode (Time)

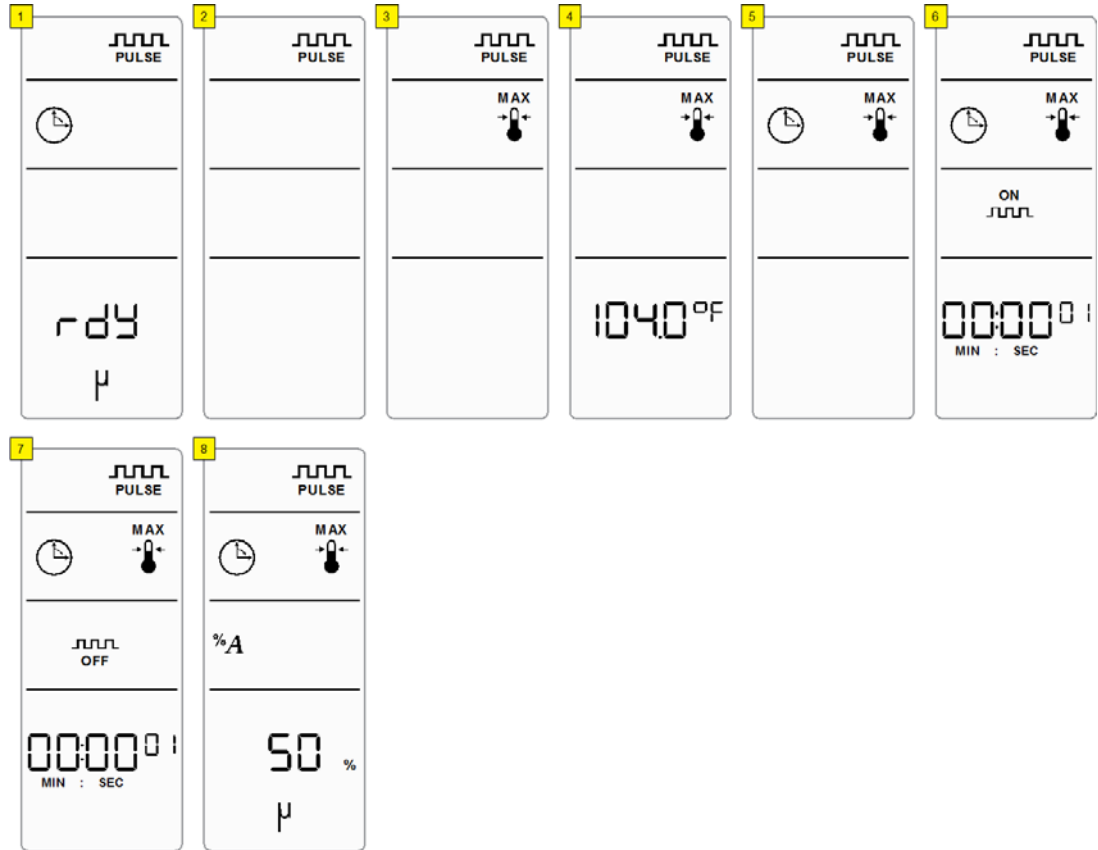

6.5.10 Maximum Temperature - Pulsed Sonics Mode (Energy)

NOTICE

Maximum Temperature Mode will only be available if a temperature probe is connected.

Table 6.27 Maximum Temperature - Pulsed Sonics Mode (Energy) Parameters

Parameter	Default	Max. Value	Min. Value
Amplitude	50%	100% (70% with microtip)	10%
Max. Temperature	104.0°F (40.0°C)	212.0°F (100.0°C)	32.0°F (0.0°C)
Off Time	1 hs (10 ms)	59 m 59 s 99 hs (990 ms)	1 hs (10 ms)
On Energy	1 J	9999 J	1 J

Table 6.28 Maximum Temperature - Pulsed Sonics Mode (Energy) Setup Sequence

Step	Action
1	Turn on power, wait for the LCD to show rdy and current mode. Press the Up, Down, or Enter key once to get into sonics mode selection.
2	Use the Left and Right keys to select Pulsed mode, then press the Enter key to confirm the selection.
3	Use the Left and Right keys to select Maximum Temperature mode, then press the Enter key to confirm the selection.
4	Use the Navigation keys to set the desired Maximum Temperature parameter, then press the Enter key to confirm the entered value.
5	Use the Left and Right keys to select Energy mode, then press the Enter key to confirm the selection.
6	Use the Navigation keys to set the desired On Energy parameter, then press the Enter key to confirm the entered value.
7	Use the Navigation keys to set the desired Off Time parameter, then press the Enter key to confirm the entered value.
8	Use the Navigation keys to set the desired Amplitude parameter, then press the Enter key to confirm the entered value.
9	You will be returned to the rdy screen.

Figure 6.12 Maximum Temperature - Pulsed Sonics Mode (Energy)

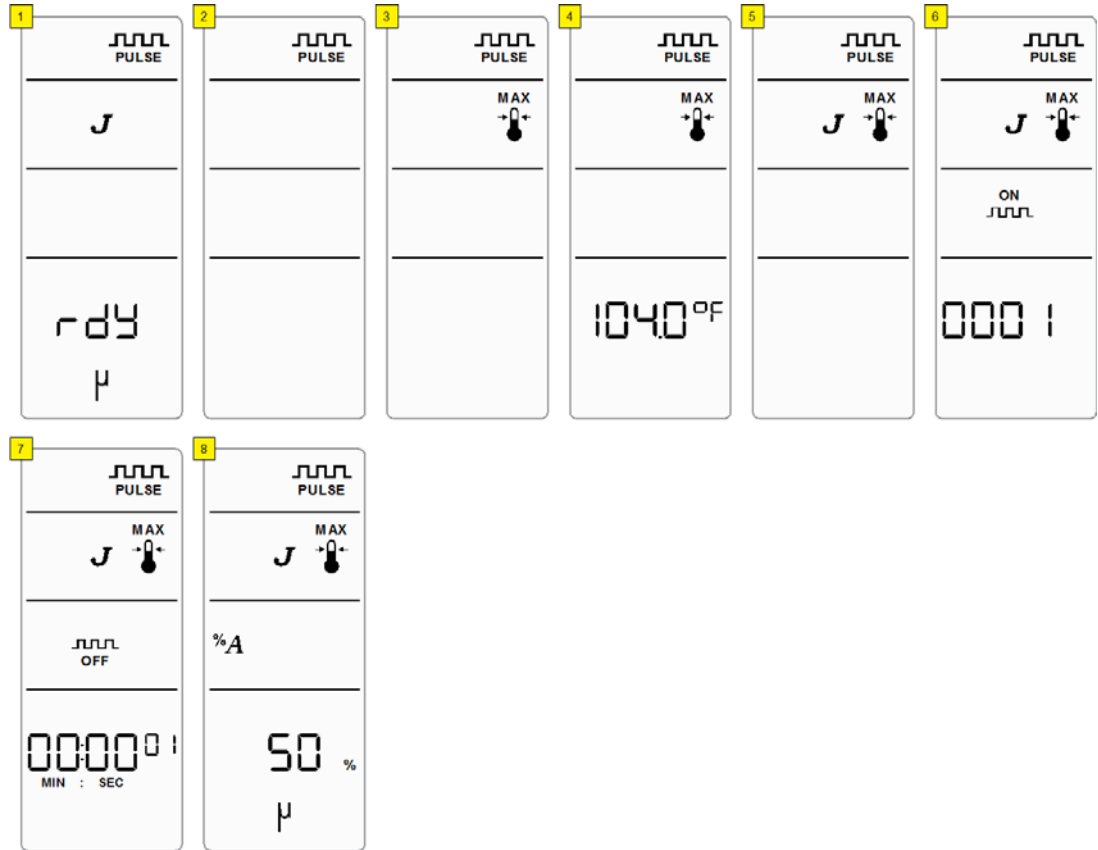

6.5.11 Temperature Limit - Continuous Sonics (Time) Mode

NOTICE

Maximum Temperature Mode will only be available if a temperature probe is connected.

Table 6.29 Temperature Limit - Continuous Sonics (Time) Mode Parameters

Parameter	Default	Max. Value	Min. Value
Amplitude	50%	100% (70% with microtip)	10%
Time	0 hrs 1 min 0 s	99 hrs 59 min 59 s	00 hrs 00 min 01 s*
Max. Temperature	104.0°F (40.0°C)	212.0°F (100.0°C)	32.0°F (0.0°C)

*If set to 00:00:00 cycle will run as Continuous Sonics - Infinite Mode. See [6.5.3 Continuous Sonics - Infinite Mode](#) for more information.

Table 6.30 Temperature Limit - Continuous Sonics (Time) Mode Setup Sequence

Step	Action
1	Turn on power, wait for the LCD to show rdy and current mode. Press the Up, Down, or Enter key once to get into sonics mode selection.
2	Use the Left and Right keys to select Continuous mode, then press the Enter key to confirm the selection.
3	Use the Left and Right keys to select Time mode, then press the Enter key to confirm the selection.
4	Use the Navigation keys to set the desired Time parameter, then press the Enter key to confirm the entered value.
5	Use the Navigation keys to set the desired Maximum Temperature parameter, then press the Enter key to confirm the entered value.
6	Use the Navigation keys to set the Pulse Temperature to off, then press the Enter key to confirm the setting.
7	Use the Navigation keys to set the desired Amplitude parameter, then press the Enter key to confirm the entered value.
8	You will be returned to the rdy screen.

Figure 6.13 Temperature Limit - Continuous Sonics (Time) Mode



6.5.12 Temperature Limit - Continuous Sonics (Energy) Mode

NOTICE

Maximum Temperature Mode will only be available if a temperature probe is connected.

Table 6.31 Temperature Limit - Continuous Sonics (Energy) Mode Parameters

Parameter	Default	Max. Value	Min. Value
Amplitude	50%	100% (70% with microtip)	10%
Energy	1 J	999999 J	1 J
Max. Temperature	OFF	212.0°F (100.0°C)	32.0°F (0.0°C)

Table 6.32 Temperature Limit - Continuous Sonics (Energy) Mode Setup Sequence

Step	Action
1	Turn on power, wait for the LCD to show rdy and current mode. Press the Up, Down, or Enter key once to get into sonics mode selection.
2	Use the Left and Right keys to select Continuous mode, then press the Enter key to confirm the selection.
3	Use the Left and Right keys to select Energy mode, then press the Enter key to confirm the selection.
4	Use the Navigation keys to set the desired Energy parameter, then press the Enter key to confirm the setting.
5	Use the Navigation keys to set the desired Maximum Temperature parameter, then press the Enter key to confirm the entered value.
6	Use the Navigation keys to set the Pulse Temperature to off, then press the Enter key to confirm the setting.
7	Use the Navigation keys to set the desired Amplitude parameter, then press the Enter key to confirm the entered value.
8	You will be returned to the rdy screen.

Figure 6.14 Temperature Limit - Continuous Sonics (Energy) Mode



6.5.13 Temperature Limit - Pulsed Sonics (Time) Mode

NOTICE

Maximum Temperature Mode will only be available if a temperature probe is connected

Table 6.33 Temperature Limit - Pulsed Sonics (Time) Mode Parameters

Parameter	Default	Max. Value	Min. Value
Amplitude	50%	100% (70% with microtip)	10%
On Time	1 hs (10 ms)	59 m 59 s 99 hs (990 ms)	1 hs (10 ms)
Off Time	1 hs (10 ms)	59 m 59 s 99 hs (990 ms)	1 hs (10 ms)
Total On (Time)	0 hrs 1 min 0 s	99 hrs 59 min 59 s	00 hrs 00 min 01 s*
Max. Temperature	OFF	212.0°F (100.0°C)	32.0°F (0.0°C)

*If set to 00:00:00 cycle will run as Pulsed Sonics - Infinite Mode (Time). See [6.5.6 Pulsed Sonics - Infinite Mode \(Time\)](#) for more information.

Table 6.34 Temperature Limit - Pulsed Sonics (Time) Mode Setup Sequence

Step	Action
1	Turn on power, wait for the LCD to show rdy and current mode. Press the Up, Down, or Enter key once to get into sonics mode selection.
2	Use the Left and Right keys to select Pulsed mode, then press the Enter key to confirm the selection.
3	Use the Left and Right keys to select Time mode, then press the Enter key to confirm the selection.
4	Use the Navigation keys to set the desired On Time parameter, then press the Enter key to confirm the entered value.
5	Use the Navigation keys to set the desired Off Time parameter, then press the Enter key to confirm the entered value.
6	Use the Navigation keys to set the desired Total On (Time) parameter, then press the Enter key to confirm the entered value.
7	Use the Navigation keys to set the desired Maximum Temperature parameter, then press the Enter key to confirm the entered value.
8	Use the Navigation keys to set the Pulse Temperature to off, then press the Enter key to confirm the setting.
9	Use the Navigation keys to set the desired Amplitude parameter, then press the Enter key to confirm the entered value.
10	You will be returned to the rdy screen.

Figure 6.15 Temperature Limit - Pulsed Sonics (Time) Mode

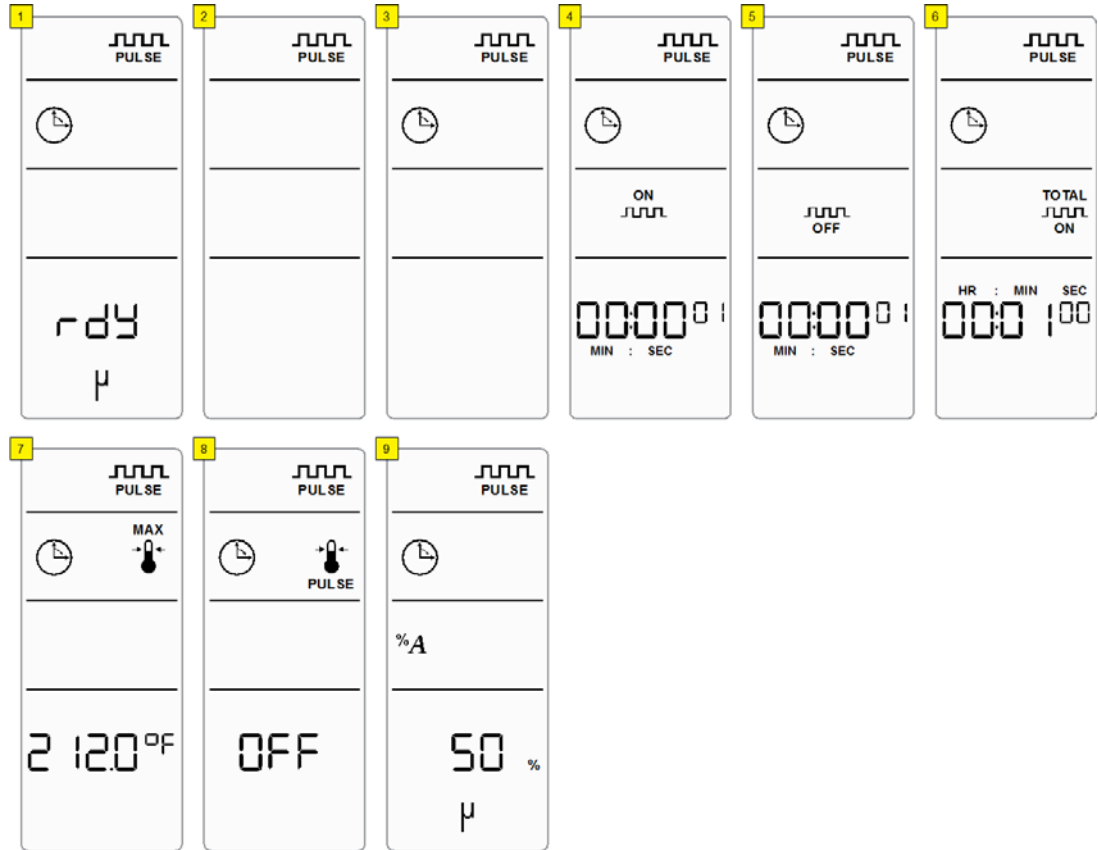

6.5.14 Temperature Limit - Pulsed Sonics (Energy) Mode

NOTICE

Maximum Temperature Mode will only be available if a temperature probe is connected.

Table 6.35 Temperature Limit - Pulsed Sonics (Energy) Mode Parameters

Parameter	Default	Max. Value	Min. Value
Amplitude	50%	100% (70% with microtip)	10%
On Energy	1 J	9999 J	1 J
Off Time	1 hs (10 ms)	59 m 59 s 99 hs (990 ms)	1 hs (10 ms)
Total On (Energy)	1 J	999999 J	1 J*
Max. Temperature	OFF	212.0°F (100.0°C)	32.0°F (0.0°C)

*If set to 0 J cycle will run as Pulsed Sonics - Infinite Mode (Energy). See [6.5.7 Pulsed Sonics - Infinite Mode \(Energy\)](#) for more information.

Table 6.36 Temperature Limit - Pulsed Sonics (Energy) Mode Setup Sequence

Step	Action
1	Turn on power, wait for the LCD to show rdy and current mode. Press the Up, Down, or Enter key once to get into sonics mode selection.
2	Use the Left and Right keys to select Pulsed mode, then press the Enter key to confirm the selection.
3	Use the Left and Right keys to select Energy mode, then press the Enter key to confirm the selection.
4	Use the Navigation keys to set the desired On Energy parameter, then press the Enter key to confirm the entered value.
5	Use the Navigation keys to set the desired Off Time parameter, then press the Enter key to confirm the entered value.
6	Use the Navigation keys to set the desired Total On (Energy) parameter, then press the Enter key to confirm the entered value.
7	Use the Navigation keys to set the desired Maximum Temperature parameter, then press the Enter key to confirm the entered value.
8	Use the Navigation keys to set the Pulse Temperature to off, then press the Enter key to confirm the setting.
9	Use the Navigation keys to set the desired Amplitude parameter, then press the Enter key to confirm the entered value.
10	You will be returned to the rdy screen.

Figure 6.16 Temperature Limit - Pulsed Sonics (Energy) Mode

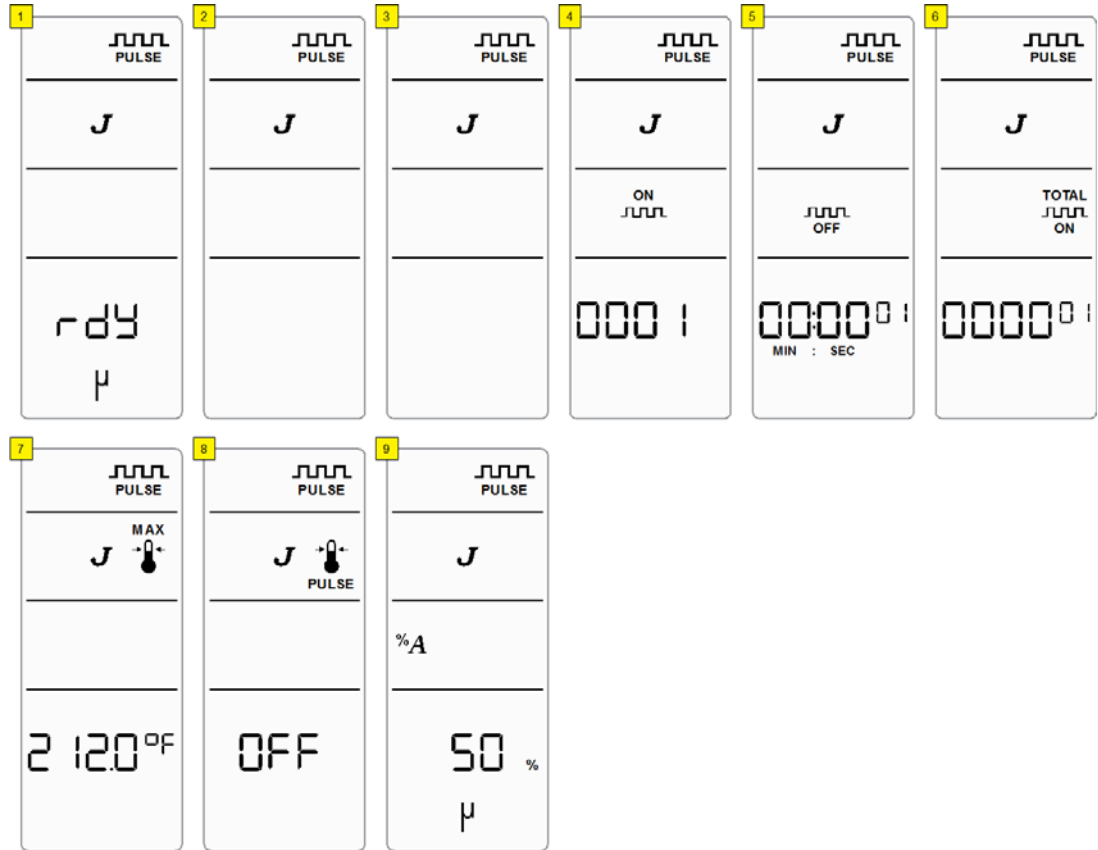

6.5.15 Pulse Temperature - Continuous Sonics (Time) Mode

NOTICE

Maximum Temperature Mode will only be available if a temperature probe is connected.

Table 6.37 Pulse Temperature - Continuous Sonics (Time) Mode Parameters

Parameter	Default	Max. Value	Min. Value
Amplitude	50%	100% (70% with microtip)	10%
Time	0 hrs 1 min 0 s	99 hrs 59 min 59 s	00 hrs 00 min 01 s*
Max. Temperature	OFF	212.0°F (100.0°C)	32.0°F (0.0°C)
Pulse Temperature	OFF	Max. Temp. -3°F (Max. Temp -2°C)	32°F (0°C)

*If set to 00:00:00 cycle will run as Continuous Sonics - Infinite Mode. See [6.5.3 Continuous Sonics - Infinite Mode](#) for more information.

Table 6.38 Pulse Temperature - Continuous Sonics (Time) Mode Setup Sequence

Step	Action
1	Turn on power, wait for the LCD to show rdy and current mode. Press the Up, Down, or Enter key once to get into sonics mode selection.
2	Use the Left and Right keys to select Continuous mode, then press the Enter key to confirm the selection.
3	Use the Left and Right keys to select Time mode, then press the Enter key to confirm the selection.
4	Use the Navigation keys to set the desired Time parameter, then press the Enter key to confirm the entered value.
5	Use the Navigation keys to set the desired Maximum Temperature parameter, then press the Enter key to confirm the entered value.
6	Use the Navigation keys to set the desired Pulse Temperature parameter, then press the Enter key to confirm the entered value.
7	Use the Navigation keys to set the desired Amplitude parameter, then press the Enter key to confirm the entered value.
8	You will be returned to the rdy screen.

Figure 6.17 Pulse Temperature - Continuous Sonics (Time) Mode



6.5.16 Pulse Temperature - Continuous Sonics (Energy) Mode

NOTICE

Maximum Temperature Mode will only be available if a temperature probe is connected.

Table 6.39 Pulse Temperature - Continuous Sonics (Energy) Mode Parameters

Parameter	Default	Max. Value	Min. Value
Amplitude	50%	100% (70% with microtip)	10%
Energy	1 J	999999 J	1 J
Max. Temperature	OFF	212.0°F (100.0°C)	32.0°F (0.0°C)
Pulse Temperature	OFF	Max. Temp. -3°F (Max. Temp - 2°C)	32°F (0°C)

Table 6.40 Pulse Temperature - Continuous Sonics (Energy) Mode Setup Sequence

Step	Action
1	Turn on power, wait for the LCD to show rdy and current mode. Press the Up, Down, or Enter key once to get into sonics mode selection.
2	Use the Left and Right keys to select Continuous mode, then press the Enter key to confirm the selection.
3	Use the Left and Right keys to select Energy mode, then press the Enter key to confirm the selection.
4	Use the Navigation keys to set the desired Energy parameter, then press the Enter key to confirm the entered value.
5	Use the Navigation keys to set the desired Maximum Temperature parameter, then press the Enter key to confirm the entered value.
6	Use the Navigation keys to set the desired Pulse Temperature parameter, then press the Enter key to confirm the entered value.
7	Use the Navigation keys to set the desired Amplitude parameter, then press the Enter key to confirm the entered value.
8	You will be returned to the rdy screen.

Figure 6.18 Pulse Temperature - Continuous Sonics (Energy) Mode



6.5.17 Pulse Temperature - Pulsed Sonics (Time) Mode

NOTICE

Maximum Temperature Mode will only be available if a temperature probe is connected.

Table 6.41 Pulse Temperature - Pulsed Sonics (Time) Mode Parameters

Parameter	Default	Max. Value	Min. Value
Amplitude	50%	100% (70% with microtip)	10%
On Time	1 hs (10 ms)	59 m 59 s 99 hs (990 ms)	1 hs (10 ms)
Off Time	1 hs (10 ms)	59 m 59 s 99 hs (990 ms)	1 hs (10 ms)
Total On (Time)	0 hrs 1 min 0 s	99 h 59 m 59 s	00 hrs 00 min 01 s*
Max. Temperature	OFF	212.0°F (100.0°C)	32.0°F (0.0°C)
Pulse Temperature	OFF	Max. Temp. -3°F (Max. Temp -2°C)	32°F (0°C)

*If set to 00:00:00 cycle will run as Pulsed Sonics - Infinite Mode (Time). See [6.5.6 Pulsed Sonics - Infinite Mode \(Time\)](#) for more information.

Table 6.42 Pulse Temperature - Pulsed Sonics (Time) Mode Setup Sequence

Step	Action
1	Turn on power, wait for the LCD to show rdy and current mode. Press the Up, Down, or Enter key once to get into sonics mode selection.
2	Use the Left and Right keys to select Pulsed mode, then press the Enter key to confirm the selection.
3	Use the Left and Right keys to select Time mode, then press the Enter key to confirm the selection.
4	Use the Navigation keys to set the desired On Time parameter, then press the Enter key to confirm the entered value.
5	Use the Navigation keys to set the desired Off Time parameter, then press the Enter key to confirm the entered value.
6	Use the Navigation keys to set the desired Total On (Time) parameter, then press the Enter key to confirm the entered value.
7	Use the Navigation keys to set the desired Maximum Temperature parameter, then press the Enter key to confirm the entered value.
8	Use the Navigation keys to set the desired Pulse Temperature parameter, then press the Enter key to confirm the entered value.
9	Use the Navigation keys to set the desired Amplitude parameter, then press the Enter key to confirm the entered value.
10	You will be returned to the rdy screen.

Figure 6.19 Pulse Temperature - Pulsed Sonics (Time) Mode

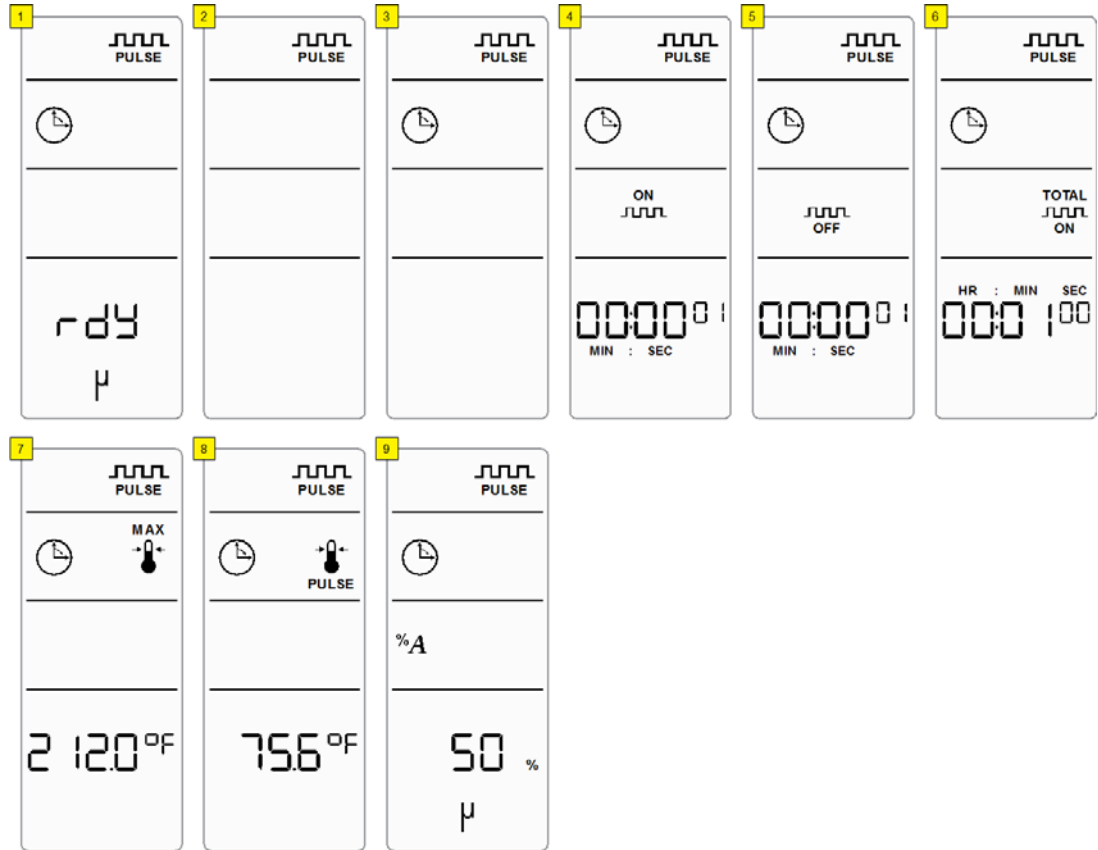

6.5.18 Pulse Temperature - Pulsed Sonics (Energy) Mode

NOTICE

Maximum Temperature Mode will only be available if a temperature probe is connected.

Table 6.43 Pulse Temperature - Pulsed Sonics (Energy) Mode Parameters

Parameter	Default	Max. Value	Min. Value
Amplitude	50%	100% (70% with microtip)	10%
Off Time	1 hs (10 ms)	59 m 59 s 99 hs (990 ms)	1 hs (10 ms)
On Energy	1 J	9999 J	1 J
Total On (Energy)	1 J	999999 J	1 J*
Max. Temperature	OFF	212.0°F (100.0°C)	32.0°F (0.0°C)
Pulse Temperature	OFF	Max. Temp. -3°F (Max. Temp - 2°C)	32°F (0°C)

*If set to 00:00:00 cycle will run as Pulsed Sonics - Infinite Mode (Energy). See [6.5.7 Pulsed Sonics - Infinite Mode \(Energy\)](#) for more information.

Table 6.44 Pulse Temperature - Pulsed Sonics (Energy) Mode Setup Sequence

Step	Action
1	Turn on power, wait for the LCD to show rdy and current mode. Press the Up, Down, or Enter key once to get into sonics mode selection.
2	Use the Left and Right keys to select Pulsed mode, then press the Enter key to confirm the selection.
3	Use the Left and Right keys to select Energy mode, then press the Enter key to confirm the selection.
4	Use the Navigation keys to set the desired On Energy parameter, then press the Enter key to confirm the entered value.
5	Use the Navigation keys to set the desired Off Time parameter, then press the Enter key to confirm the entered value.
6	Use the Navigation keys to set the desired Total On (Energy) parameter, then press the Enter key to confirm the entered value.
7	Use the Navigation keys to set the desired Maximum Temperature parameter, then press the Enter key to confirm the entered value.
8	Use the Navigation keys to set the desired Pulse Temperature parameter, then press the Enter key to confirm the entered value.
9	Use the Navigation keys to set the desired Amplitude parameter, then press the Enter key to confirm the entered value.
10	You will be returned to the rdy screen.

Figure 6.20 Pulse Temperature - Pulsed Sonics (Energy) Mode

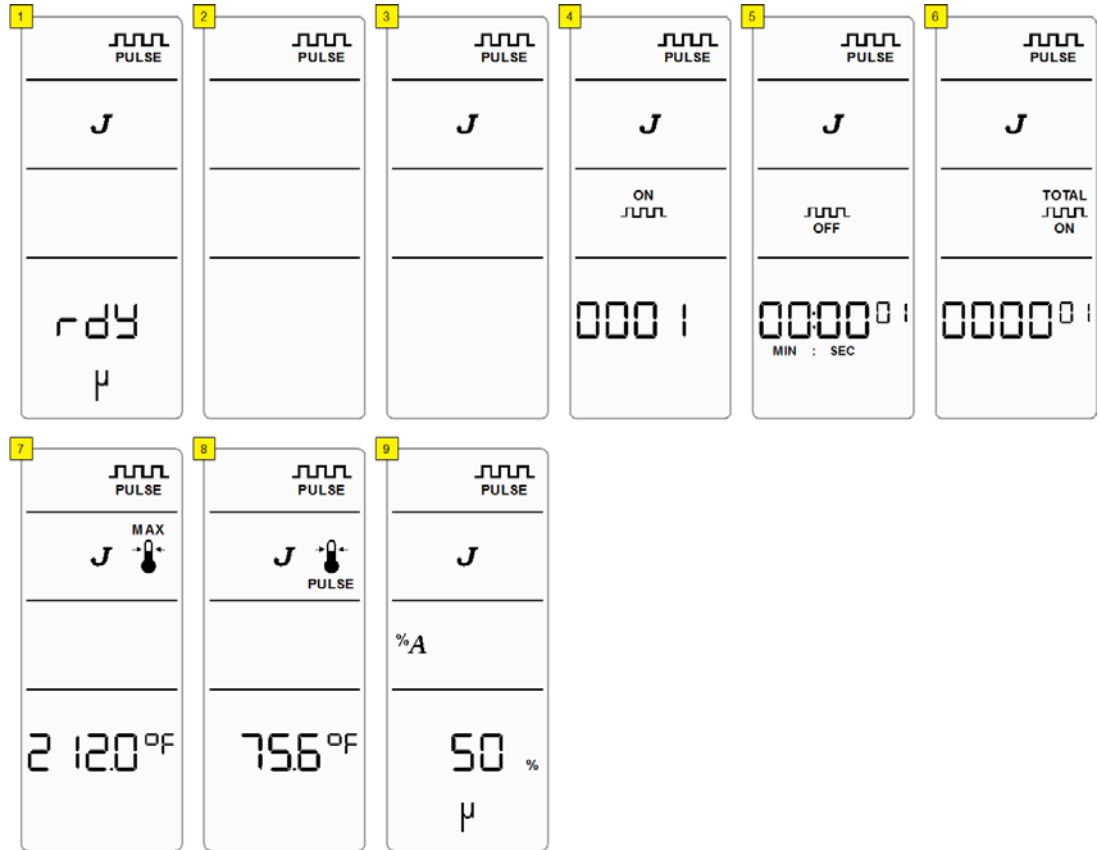

6.6 Save/Load Control Setup

If you wish to save your current ultrasonic cycle control settings for later use, you can save it into non-volatile memory location. These locations are called preset memory locations. Twenty such memory locations are available. Preset control settings are saved until they are over-written, and are maintained in memory even if the system is turned off or unplugged.

6.6.1 Save Control Setup to a Preset Memory Location

Table 6.45 Save Control Setup to a Preset Memory Location

Step	Action
1	Set the desired control mode and parameters. For more information see 6.5 Setup Sequence .
2	Press the Preset key while on the rdy screen. NOTICE The first image below shows the rdy screen when current control settings are not saved. When current control settings are saved to memory or recalled the rdy screen will display the PRESET icon while they remain unmodified.
3	The Load Preset icon and digits will appear on the LCD. Press the Left/Right keys to change between loading and saving control presets.
4	The Save icon, SA (indicating preset saving), and digits will appear on the LCD. The digits under the Preset icon indicate the preset memory location. Select the preset number using the Up/Down keys, then press the Enter key. This will save the current settings to the selected preset memory location and will return to the rdy screen.

Figure 6.21 Save Control Setup to a Preset Memory Location

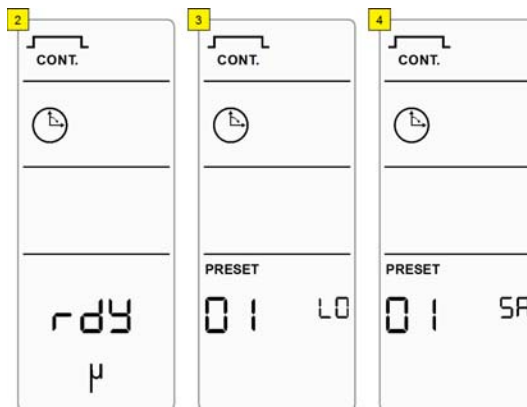

NOTICE

Press the ESC key to return to the rdy screen without saving a preset.

6.6.2 Load Control Setup from a Preset Memory Location

Table 6.46 Load Control Setup from a Preset Memory Location

Step	Action
1	Press the Preset key while on the rdy screen.
2	The Preset icon and digits will appear on the LCD. The digits under the Preset icon indicate the preset memory location. Select the preset number using the Up/Down keys, then press the Enter key. This will load the saved preset control settings from the selected preset memory location and will return to the rdy screen.

Figure 6.22 Load Preset

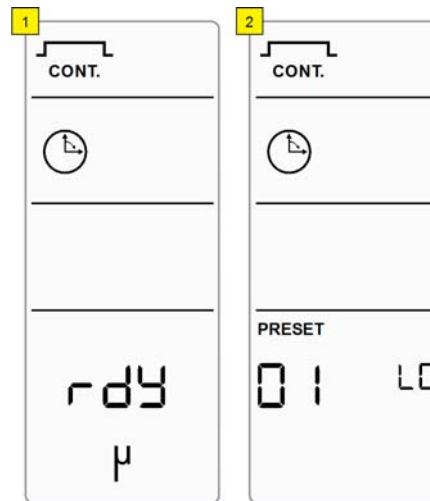

NOTICE

Press the ESC key to return to the rdy screen without loading a preset.

Chapter 7: Maintenance

7.1	Maintenance and Troubleshooting	96
7.2	Reconditioning the Stack Interface	98
7.3	Troubleshooting Chart	101
7.4	Alarms/Errors.	103

7.1 Maintenance and Troubleshooting

The Sonifier power supply is a self-contained system that requires no internal servicing, except for a protective fuse, and there are no user serviceable parts inside the unit. The ultrasonic tooling (horns and tips) may require periodic inspection and maintenance to ensure optimum performance. The tooling components are subject to wear and may require replacement after a period of time, depending on the application.

If you have a problem operating your unit, refer to [Table 7.2 System Trouble Analysis Chart](#) in this chapter to locate the symptom that most clearly describes your problem.

Tip Erosion

Horn tips can erode. Tip erosion is a side effect of the cavitation process that occurs when liquids are exposed to ultrasonic energy. The rate of erosion depends on the intensity of power applied, the corrosiveness of the liquid being treated, and the amount of use.

Periodically inspecting the tip will help you recognize erosion early. As erosion progresses, the color of the tip changes from its original polished appearance, first to light gray and then to dark gray. Concentric rings begin to appear, and finally the tip becomes rough and pitted, resulting in loss of power output. As it erodes, the tip can also introduce metal particles into the solution, causing it to darken or discolor.

Eventually, erosion may become significant, at which point the tip will require replacement.

General Cleaning

It is good practice to keep your Sonifier system clean and free of contamination.

1. Unplug the power cord, the RF cable, and the User I/O cable
2. Use a damp soft cloth with a mild detergent to remove any contamination on the outside of the unit

NOTICE

Care should be taken so that no water or other liquid enters the unit.

3. Care should be taken so that excessive force is not exerted on the membrane/keypad area
4. Reconnect cables and replugin power cord when dry

Power Output Loss

There are several conditions that can cause a decrease-in or loss-of power output, including:

- Operating with a faulty Sonifier power supply or poor electrical connection
- Operating with a loose horn-converter connection
- Operating with a cracked or corroded horn/tip assembly

If your unit indicates a decrease in power output, first check the converter cable connections, then take the following steps to ensure that the horn/tip assembly is not loose or cracked or corroded.

Fretting corrosion refers to a black, crusty build-up, resulting from friction between metal parts that appears on the mating metal surfaces. Corrosion can reduce or alter system performance. Examine all mating surfaces (tip/horn to converter, tip to horn) and wipe the surfaces clean with a clean cloth or paper towel.

The Sonifier power supply does not require tuning. Tuning is done in the factory and cannot be performed by the operator.

7.2 Reconditioning the Stack Interface

Ultrasonic system components work most efficiently when the mating surfaces of the converter-horn-tip, or converter-tip combination (also called a "stack") are flat, in solid contact, and free from fretting corrosion. Fretting corrosion refers to a black, crusty build-up, resulting from friction between metal parts, that appears on the Stack mating surfaces. Poor contact between mating surfaces wastes power output, makes tuning difficult, increases noise and heat, and may cause damage to the converter.

7.2.1 Refacing the Mating Surfaces

NOTICE

Never clean the converter or Horn mating surfaces with a buffing wheel.

1. Disassemble the stack and wipe the mating surfaces with a clean cloth or paper towel
2. Examine all mating surfaces. If any mating surface shows corrosion or a hard, dark deposit, recondition it
3. If necessary, remove the threaded stud from the part
4. Tape a clean sheet of #400 (or finer) grit emery cloth to a clean, smooth, flat surface (such as a sheet of plate glass)

Figure 7.1 Reconditioning Ultrasonic Stack Mating Surfaces

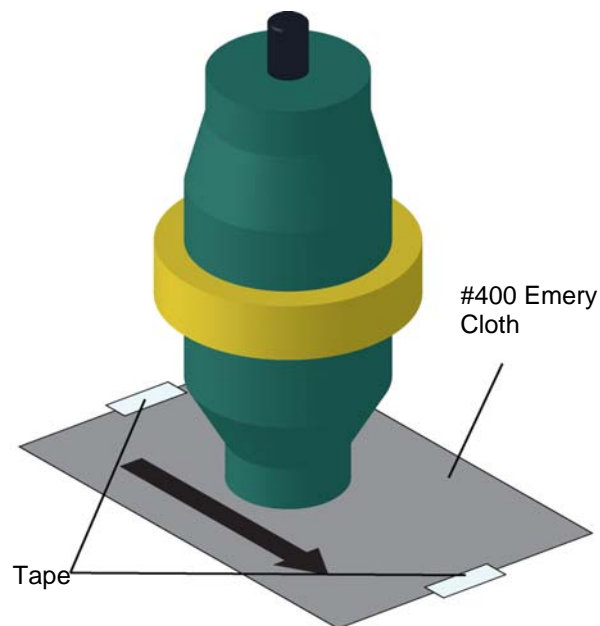

NOTICE

Be careful to avoid tilting the part and losing flatness of the surface. Doing so may make the system inoperative, due to improper mating surfaces.

Lapping Procedure

5. Holding the part to recondition, place the interface surface on the emery cloth. Grasp the part at the lower end, with your thumb over the spanner-wrench hole, and lap the part in a straight line across the emery cloth

NOTICE

Do not apply downward pressure. The weight of the part alone provides sufficient pressure.

6. Rotate the part 120 degrees (1/3) to the next hole
7. Stroke the part an equal number of times at each rotation (2 or 3)
8. Pick up the part and lap it once or twice in the same direction
9. Rotate the part 120 degrees, placing your thumb over the spanner-wrench hole, and lap the part the same number of times as described above
10. Rotate the part another 120 degrees to the next spanner-wrench hole, and repeat the lapping procedure

Re-examine the mating surface. If necessary, repeat steps 5 through 10 until you remove most of the contaminant. This should not require more than two to three complete rotations for an aluminum horn or booster; a titanium component may require more rotations.

7.2.2 Horn Tip Cleaning

Take the following steps to clean the horn's tip threads:

1. If the horn has a replaceable tip, remove it and clean its threads in alcohol
2. Swab out the end of the horn threads with a cotton swab and alcohol
3. Make sure both the horn and the tip are clean and completely dry before you reassemble them

NOTICE

Refer to the Tip installation procedures for information on tightening the Tips. This is found in [5.4 Connecting Tips, Horns, and Converters](#).

4. Use a spanner wrench on the horn and an open-end wrench on the tip to install the tip using the appropriate torque specifications. See [5.4.2 Connecting the Tip to the Horn](#) for more information

7.2.3 Stud Reinsertion

The stud is intended to be a use-only-once part, as it has knurls on its end which 'bite' into the relatively softer horn material. The studs are also specially designed to withstand ultrasonic stresses. Studs can only be re-used with aluminum horns. If you must re-use a stud from an aluminum horn, follow the following procedure:

1. Clean the threads and the horn of the previous shavings
2. Using a file card or wire brush, clean any chips from the knurled end of the stud
3. Using a clean cloth or towel, clean the threaded hole

4. Examine the knurled end of the stud. If worn, replace the stud. Examine the stud and threaded hole for stripped threads. Do not use a damaged ultrasonic horn, tip, or converter

NOTICE

Threaded studs cannot be re-used in titanium horns.

5. Clean the stud and the threaded hole before reinserting it
6. Apply one drop of Loctite[®] to the stud and insert it into the horn
7. Re-tighten the stud. Use the following torque specifications:

Table 7.1 Torque Specifications

Stud Size	Torque Specification	Stud EDP Number
3/8-24 x 1-1/4 in	290 in lbs/33 Nm	100-098-121
3/8-24 x 1-1/2 in	290 in lbs/33 Nm	100-098-120
1/2-20 x 1-1/4 in	450 in lbs/51 Nm	100-098-370
1/2-20 x 1-1/2 in	450 in lbs/51 Nm	100-098-123

After the stud has been reinserted, you can reassemble the horn or tip to the converter. Follow the same procedure as found in the installation section of this manual. See [5.4 Connecting Tips, Horns, and Converters](#).

7.3 Troubleshooting Chart

Use the following troubleshooting chart for possible problem conditions and resolutions. The chart is based on the assumption that the proper setup and operation instructions have been followed and/or the system was working and then developed a problem.

Table 7.2 System Trouble Analysis Chart

Symptom	Probable Cause	Corrective Action
Main power fuse fails or circuit breaker trips when system is plugged into electrical outlet	<ul style="list-style-type: none"> • Cordset has failed 	<ul style="list-style-type: none"> • Replace cordset
	<ul style="list-style-type: none"> • Power Switch has failed • Line filter has failed 	<ul style="list-style-type: none"> • Return for repair
LCD Screen does not turn on when unit is turned on. Fan does not operate	<ul style="list-style-type: none"> • System is unplugged or main power is missing 	<ul style="list-style-type: none"> • Correct power problem
	<ul style="list-style-type: none"> • Unit fuse has blown (it should not under normal conditions) 	<ul style="list-style-type: none"> • Replace fuse
	<ul style="list-style-type: none"> • Cordset has failed 	<ul style="list-style-type: none"> • Replace cordset
	<ul style="list-style-type: none"> • Power Switch has failed • Line filter has failed • Unit failed due to connection to incorrect input voltage 	<ul style="list-style-type: none"> • Return for repair
Fan does not operate when system is turned on. LCD Screen turns on	<ul style="list-style-type: none"> • Fan motor has failed 	<ul style="list-style-type: none"> • Return for repair
Fuse fails when system is turned on	<ul style="list-style-type: none"> • Fuse is under-rated • Mains Voltage is incorrect • Fan motor has failed • Sonifier power supply module has failed • Unit failed due to connection to incorrect input voltage 	<ul style="list-style-type: none"> • Verify voltage source is correct. Damage may occur if connected to wrong voltage source • Replace fuse with correct value and retry; or return for repair
Ultrasonic power is not delivered to the horn	<ul style="list-style-type: none"> • Sonifier power supply module has failed • Digital controls have failed • Failed RF cable • Failed Converter 	<ul style="list-style-type: none"> • Return for repair
Unusual noise from Horn when ultrasonics are on	<ul style="list-style-type: none"> • Horn or Tip is loose, or it is contacting a solid object 	<ul style="list-style-type: none"> • Reposition horn • Remove, examine, and clean tip; reinstall tip
	<ul style="list-style-type: none"> • Horn or tip has failed 	<ul style="list-style-type: none"> • Replace horn or tip

Table 7.2 System Trouble Analysis Chart

Symptom	Probable Cause	Corrective Action
Ultrasonic power is absent or inconsistent, or Sonifier power supply overloads	<ul style="list-style-type: none"> Foreign material is between horn surface and replaceable tip. If horn is hot to the touch, problem may exist with corroded tip-to-horn interface 	<ul style="list-style-type: none"> Remove, examine, and clean tip; reinstall tip Replace tip if corrosion is excessive
	<ul style="list-style-type: none"> Tip is loose or worn out Horn is loose or has failed 	<ul style="list-style-type: none"> Tighten or replace defective tip or horn
	<ul style="list-style-type: none"> Horn stud is loose or has failed 	<ul style="list-style-type: none"> Loose or broken studs must be replaced Replace defective horn
	<ul style="list-style-type: none"> Converter cable connection is loose or has failed 	<ul style="list-style-type: none"> Tighten connector to converter Return unit for repair if cable has failed
	<ul style="list-style-type: none"> Converter has failed 	<ul style="list-style-type: none"> Replace defective converter, return for repair
	<ul style="list-style-type: none"> Sonifier power supply or controls have failed 	<ul style="list-style-type: none"> Return for repair
Slight electric shock when touching a metal part of the system or lab equipment contacting the system	<ul style="list-style-type: none"> System is not properly grounded 	<ul style="list-style-type: none"> Correct electrical ground to system
	<ul style="list-style-type: none"> Cordset has failed or had Ground lead removed 	<ul style="list-style-type: none"> Replace cordset
User I/O signals are not working correctly	<ul style="list-style-type: none"> User I/O is not configured correctly Customer-designed User I/O interface system is not functioning properly 	<ul style="list-style-type: none"> Verify and correct connections - See 5.6.3 User I/O Connection
	<ul style="list-style-type: none"> Outputs of User I/O failed 	<ul style="list-style-type: none"> Return unit for repair
User I/O signals are working correctly, but still overloads	<ul style="list-style-type: none"> 	<ul style="list-style-type: none"> Call Product Support

7.4 Alarms/Errors

When the system encounters an error condition, an error message is displayed on the LCD of the Sonifier power supply, and the Alarm/Error icon will appear on the LCD.

NOTICE

Press the Reset key to reset alarms/errors.

Table 7.3 Alarms/Errors

Alarm/Error	Alarm/Error Code	Description
Overload	E0:20	Will occur if the analog controller overload signal is active (current/voltage/temperature/frequency beyond normal operating specifications).
Timeout	E1:05	Will occur if cycle timeout is reached. See 6.4 System Configuration Registers for more information.
Microtip on and amplitude > 70 %	E2:02	Will occur if amplitude is set above 70 % while the Microtip icon is on. The alarm will also occur if a preset with an amplitude setting above 70% is loaded while the Microtip icon is on or if the current preset Amplitude setting is above 70% and the Microtip key is pressed.
Invalid entry	E2:06	Will occur if a parameter or register setting is outside of its valid range.
Total cycle time > Timeout	E2:10	Will occur if the current cycle preset has a Total Time or Total ON Time setting higher than the Timeout value at the moment the cycle begins.
Start still active after end of cycle	E6:01	Will occur if Start signal or start button press are detected at power-up or if the signal is not removed within 2 seconds after the last ultrasonic cycle finished.
Invalid parameters for handheld converter	E7:08	The following conditions will trigger this alarm: <ul style="list-style-type: none"> • Current preset features a Temperature Control mode • Time or Total ON Time setting exceed 10 minutes
Front panel start	E7:09	Front panel Start/Stop key was used to try and start a cycle and a handheld converter was detected.

Table 7.3 Alarms/Errors

Alarm/Error	Alarm/ Error Code	Description
Temperature probe disconnected	E9:01	<p>Will occur if a start signal or start button press is detected for control settings requiring temperature probe and none is detected.</p> <p>This alarm will also occur if the probe is disconnected while a cycle requiring the probe is running.</p>
Current temperature > Maximum Temperature at start of cycle	E9:02	<p>Will occur if the current preset has a current temperature higher than or equal to the Maximum Temperature value at the moment that the cycle begins.</p>
RAM failure	EA:01	<p>During power-up and preset recalling memory is verified. This alarm will result if a RAM memory failure is detected.</p>

Appendix A: Application Information

A.1	Operating Considerations	106
A.2	Minimizing Undesirable Factors	108
A.3	Sterilizing and Preventing Cross-Contamination	109
A.4	Disrupting Tissues and Solids	110
A.5	Ultrasonic Irradiation on Various Biological Materials.	111

A.1 Operating Considerations

The following sections discuss operating techniques under varying conditions.

A.1.1 Limiting Temperature Rise

An important objective in ultrasonic emulsification is to keep processed samples cool. Selection of the proper processing vessel and cooling bath resolves most heating problems. While any type of vessel can be used to hold the sample, the shape of the vessel is determined primarily by the volume to be processed. For small volumes, choose the smallest diameter vessel that allows the probe to be inserted without touching the sides of the vessel. This minimized diameter raises the height of the liquid, exposing more surface area to the cooling bath for more effective heat transfer.

Based on heat transfer characteristics, the following vessel materials are recommended, listed in decreasing order of heat conductivity:

1. Aluminum
2. Stainless steel
3. Thin-wall glass
4. Thick-wall glass
5. Plastic

NOTICE

Plastic vessels are not recommended unless the sample being processed will be unaffected by heat or unless ultrasonic treatment is pulsed.

Immersing the processing vessel in a simple ice-water bath (0°C) provides sufficient cooling for larger sample volumes, if required treatment times are short. If temperature rise is too great with this method, consider using the following alternative baths:

- Ice-salt (-6°C)
- Ice-alcohol (-14°C)
- Dry ice-alcohol-water (-30° to -40°C)

NOTICE

All baths need a magnetic stirrer.

For smaller volumes with less than 30 seconds treatment time, an ice-water bath is sufficient. For longer periods, especially when high power is required, a lower temperature bath is required.

A.1.2 Vessel Capacity and Speed of Temperature Rise

The smaller the volume, the more difficult the cooling procedure becomes. For example, using any given power input, to treat 5 ml for a long period would require a cooling bath of approximately -31°F/-35°C to maintain the sample at or below 41°F/5°C. In comparison, the processing of 200 ml would require a cooling bath of only 32°F/0°C to maintain the sample temperature.

[Table A.1](#) shows typical temperature rises for sample sizes of 25 ml and 100 ml, using a Sonifier system. A polyethylene container was used, with a 1/2 inch (12.7 mm) diameter probe with a probe depth of 1/2 inch (12.7 mm) and a starting temperature of 77°F/25°C. "Average Difference" was the average difference among duplicate runs.

Table A.1 Temperature Rise Variations for Different Volumes, Time and Amplitude Settings (°C)

Sample Size	25 ml			100 ml		
	30%	70%	100%	30%	70%	100%
Amplitude Setting	30%	70%	100%	30%	70%	100%
Seconds						
30s	30.0°C	35.0°C	42.0°C	26.5°C	27.5°C	29.3°C
60s	34.0°C	45.0°C	55.6°C	27.5°C	30.3°C	33.5°C
120s	42.0°C	61.0°C	78.0°C	30.0°C	35.0°C	41.3°C
180s	48.5°C	74.0°C	90.0°C	32.0°C	39.3°C	48.0°C
240s	54.5°C	82.5°C	95.0°C	34.0°C	44.0°C	54.5°C
300s	60.0°C	88.0°C	95.0°C	36.0°C	48.0°C	60.0°C
Average Difference	±0.7°C	±0.4°C	±0.4°C	±0°C	±0.2°C	±1.6°C

Table A.2 Temperature Rise Variations for Different Volumes, Time and Amplitude Settings (°F)

Sample Size	25 ml			100 ml		
	30%	70%	100%	30%	70%	100%
Amplitude Setting	30%	70%	100%	30%	70%	100%
Seconds						
30s	86.0°F	95.0°F	107.6°F	79.7°F	81.5°F	84.7°F
60s	93.2°F	113°F	132°F	81.5°F	86.5°F	92.3°F
120s	107.6°F	141.8°F	172.4°F	86°F	95°F	106.3°F
180s	119.3°F	165.2°F	194°F	89.6°F	102.7°F	118.4°F
240s	130.1°F	180.5°F	203°F	93.2°F	111.2°F	130.1°F
300s	140°F	190.4°F	203°F	96.8°F	118.4°F	140°F
Average Difference	±1.26°F	±0.72°F	±0.72°F	±0	±0.36°F	±2.88°F

A.2 Minimizing Undesirable Factors

Some factors may be detrimental to enzyme or biological activity and can reduce the effectiveness of ultrasonic processing. Minimize undesirable factors, as follows:

A.2.1 Foaming or Aerosoling

Always place the horn deep enough below the surface of the liquid to prevent violent motion or agitation on the surface. This problem is more critical when processing small volumes (for example, 0.3 to 5 ml). A conical-shaped tube or vial, such as a cut-down Eppendorf tube, is recommended. The shape of this type of container raises the liquid level without increasing the volume, thereby permitting the horn to be inserted more deeply below the liquid surface level.

Foaming can be detected by a change in the sound level and a fluctuating reading on the power bar graph.

When aerosoling occurs, little or no energy couples reliably to the solution, and excessive top-layer heating results. Remedy this problem by placing the probe as deep as possible and setting the Amplitude control to 10% or 20% for a few seconds. Then gradually increase the Amplitude control to the level required.

A.2.2 Discoloration of the Processed Sample

If the tip touches the side of a glass tube or beaker, small glass particles are released, which gradually changes the sample to a grayish color. Excessive tip corrosion can also cause a graying or darkening condition.

A.3 Sterilizing and Preventing Cross-Contamination

You can sterilize horns and tips by removing them from the converter and autoclaving them. It is faster, easier, and equally effective, however, to sterilize horns by immersing them in a beaker of alcohol or other disinfectant and then turning the power on for a few seconds. This technique also removes unwanted residue from the horn and tip.

A.4 Disrupting Tissues and Solids

You can effectively homogenize or disrupt many kinds of tissue and other solids. Energy radiates only from the horn's tip. The energy is most concentrated within 1/2 inch (12.7 mm) of the face of the tip. When you treat tissue or solids in solution, the freely moving cells or particles pass the face of the tip many times during the process. When you treat a solid piece, however, the energy pattern from the tip of the horn has a tendency to repel the solid away from the tip. The solid does not receive treatment, but simply spins or circulates around the container.

You can effectively treat all but the most difficult materials by following these two steps:

1. Homogenize the tissues or solids by placing them in a high-speed blender with the solution
2. Insert the horn in the liquid sample for complete disruption

If you must disrupt solid pieces, especially those that are extremely resistant to breakage, without homogenizing them, place the horn directly over the tissue or right against it

A.4.1 Using Glass Powders with Solution

To disrupt difficult cells and tissues, adding glass powders (5 microns to 0.5 mm) will materially decrease treatment times, especially when used in conjunction with the standard, high-intensity microtip. A ratio of 1 part glass powder to 2 parts liquid is recommended.

A.5 Ultrasonic Irradiation on Various Biological Materials

Table A.3 Ultrasonic Irradiation on Various Biological Materials

Name	Description
Actinomyces	3 minutes of sonifying produces excellent disruption with 50% protein release and excellent enzyme activity.
Actinomycin D	Suspended in 3 minutes.
Aerobacter Aerogenes	Excellent breakage with better enzyme release than any other method. A low power setting can release sulfatase activity into the supernate with no obvious disruption of the majority of cells.
Aerobacter Suboxydans	Excellent breakage but requires higher power than aerogenes.
Algae Secendesmus	10 ml concentrated solution completely disrupts in 1 minute.
Alkaloids	Total amount and speed of extraction are greater than with standard methods. Extraction from ipecac root in 30 seconds yielded more alkaloid than Soxhlet extraction in 5 hours.
Antibioticus	Monocellular elements from surface-grown colonies obtained in 1 minute. Complete disruption in 5 minutes, 50% disruption in 2 minutes.
Antigen	The Sonifier system is used extensively to produce antigens and vaccines. It can increase yield or expose otherwise unobtainable sites.
Aorta	1 gram disintegrates in 2 minutes.
Aphanomyces	After blending, complete disruption in 3 minutes.
Arthobacter Tumescens	10 gm in 40 ml in 5 minutes for O coumaric reductose.
Ascaris Eggs	8 ml concentrated solution completely disrupts in 4 minutes.
Asperigillus	Complete disruption in 4 minutes.
Aurefaciens	Monocellular elements from surface-grown colonies obtained in 1 minute. Complete disruption in 5 minutes, 50% disruption in 2 minutes.
Azotobacter Vinelandii	15 ml buffered solution, 200 mg wet wt/ml completely disintegrates in 2 minutes.
B. Anthracis	80% disruption of anthracis in 4 minutes. Complete disruption of 10 ml of erysipelothrix rhusipathiae in 10 minutes.
B. Cereus Veg Cells	Disruption in a few seconds.
B. Cereus Spores	Disruption of 10 mg/6 ml in 13 minutes.
B. Megaterium Spores	Complete breakage of a concentrated 6 ml solution in 15 minutes.

Table A.3 Ultrasonic Irradiation on Various Biological Materials

Name	Description
B. Sphaericus	Major disruption in 1-3 minutes.
B. Stereothermophilis Spores	Complete disruption in 2 minutes.
B. Subtilis	Disruption of 5 gm wet wt, 15 ml buffer, in 5 minutes.
B. Subtilis Veg Cells	Heavy suspension clears in 1 minute.
Bacillus Stereothermophilus (Thermophillic Spore Form)	98% disruption of 70 ml of 40% suspension in 15 minutes.
Bacillus Brevis	1:15 W/V in 3 minutes.
Bacteroides Symbiosis	1-phosphorfructokinase (a soluble enzyme) has been isolated from this anaerobe by ultrasonic treatment. A 25 ml suspension was sonified for 10 minutes and centrifuged at 36,000 xg for 10 minutes.
Baker's Yeast (Saccharomyces Cerevisiae)	See Yeast.
Blastomyces Dermatitidis	95% disruption in 3 minutes.
Blood Cells	Red and white cells can be disrupted in a few seconds.
Boll Weevil Tissue	Complete homogenization in a few seconds.
Bone	Compact bone can be sonified and processed for microscopic sections in minutes. Other methods can require up to a week. Bone specimens treated in this way yielded large numbers of intact cells with little distortion. Malignant criteria are easily recognized. Tumor types studied were: osteosarcoma, chondrosarcoma, liposarcoma, chordoma, metastatic bronchogenic squamous and benign giant. Bone can be decalcified without injury to the cells, processed for microscopic sections, and diagnosed in a short time. Other methods require extensive treatment time.
Brain Stem And Adrenal Gland	Ultrasonic treatment dispersed 10 mg samples in 10 ml fluid, which is usually difficult without substantial loss of material. The suspension was analyzed for nucleotides.
Brain Tissue	Disintegrates instantly.
Brevi Bacterium	25 ml disrupts in 20 seconds.
Brevi Bacterium Acetylicum	Approximately 3 minutes to disrupt large samples and measure TCA enzyme activity.
Brine Shrimp	Complete disintegration in 1 minute.
Brucella Abortes	Separates easily from leucocytes. At least 9 antigens extracted.

Table A.3 Ultrasonic Irradiation on Various Biological Materials

Name	Description
Bull Sperm	Contractile protein is easier to extract from tails after sonifying.
C. Butyricum, C. Cylindrosporum, C. Kluyveri	Vegetative cells easily disrupted.
C. Pasteurianum	3 minutes disruption for hydrogens reducing Ferredoxin with H ₂ .
Calcium	Mouse Ehrlich ascites tumor cells were sonified for 1 minute to determine the amount of bound calcium present. Cells were labeled with calcium 45.
Candida Albicans Spores	95% disruption of 1/2 gram dry wt. in a 15 ml solution in 35 minutes.
Carbon Black	Excellent small particle suspension.
Caryophanon Latum	Glucosamine, muramic acid, alanine, glutamic acid and lysine were obtained.
Catecholamine	Can be extracted from heart muscle.
Cellomonas Biazotea	Disruption obtained with retention of malate dehydrogenase activity. Chicken spermatozoa: completely disrupts in 2 minutes.
Chlorella	Completely disrupts in 3 minutes.
Chloroplasts	Disrupt in a few seconds.
Cholesterol	Apparent permanent suspension in 1 minute in water.
Desulfovibrio Vulgaris	Less than 30 seconds of ultrasonic treatment resulted in release of TCA enzymes.
Diplococcus	Completely disrupts in 5 minutes.
Dna	Breaks chains on low power instantly. Controlled degradation may be obtained.
Dyes	Excellent rapid dispersion and homogenization.
E. Coli.	2 gm wet weight in 10 ml solution completely disrupts in 40 seconds. The Sonifer Cell Disruptor has been used extensively in research on this organism.
Egg Whites	Can be reduced to a homogeneous pipettable solution in 15 seconds on low power.
Ehrlich Ascites	Disrupts in a few seconds.
Electron Microscopy	Apertures are quickly cleaned.
Emulsions	10 ml of most light mixtures become semi-permanent emulsions in about 1 minute without emulsifiers. Average particle size is usually well under 1 micron. Sterile emulsions can be prepared by ultrasonic treatment for feeding to germ-free animals.

Table A.3 Ultrasonic Irradiation on Various Biological Materials

Name	Description
Enterococcus	Excellent disruption.
Erwina Cartovara	Complete disruption in 1-2 minutes depending on cell concentration.
Erythrocytes	Disrupts in a few seconds.
Euglena Gracilis	Completely disrupts in a few seconds to isolate chloroplasts.
Euglena	Complete disruption in 12 minutes, 90% disruption in 8 minutes with pigment released.
Fat Extraction	Fat can be emulsified without injuring tissue with proper power selection. Lipid layer can be stripped from spores and mycobacteria.
Fibrin	Complete suspension of 0.125 gm in 30 minutes.
Fish Gill	Complete disruption of 20 mg in 30 seconds.
Fish Tissue	Tissue homogenization for extractions and excellent particle size reduction in 8 minutes per 10 gm.
Fluorocarbons	Extended treatment time will break down particle size to well under 1 micron and gives a fine homogenate.
Fossils	Low power will clean debris from delicate fossils without injury. Micro fossils such as pollen can be separated from rocks to help identify the geological age of the strata. Removal of rock matrix.
Gamma Globulin	The Sonifer Cell Disruptor was used to solubilize protein as one of the steps in the biosynthesis of gamma globulin from rabbit spleen.
Gangliosides	Immunochemical and structure studies used ultrasonic treatment as one step.
Gastric Mucosa	Placing scrapings into a test tube and test tube into new water-filled cup horn caps permits these cells to be separated without breakage.
Graphite Molybdenum Disulfide	An excellent dispersion of this lubricant was made in a silicate binder.
Guanine	Produces colloidal suspension in 1 minute.
Gymnodinium	Solution completely disrupts in 6 minutes.
Haemophilus Pertussis	Preparation of successful immunological complexes.
Heart Muscle	1 gm disintegrates in 6 minutes.
Hela Cells	Disruption to free virus in a few seconds without injury.
Hemophilus Pertussis	An immunological compound prepared.
Herpes Virus	May be quickly released without injury.

Table A.3 Ultrasonic Irradiation on Various Biological Materials

Name	Description
Histoplasma Capsulatum	Ultrasonic treatment for 7 minutes completely ruptures cells prepared by formalin fixation. Good enzyme activity is obtained.
Human Serum Proteins	Ultrasonic treatment causes a reproducible change in the electrophoretic behavior of normal human serum consisting of an increase in material migrating in the x and b globulin zones with a reduction in the albumin and y globulin fractions.
Hydrocortisone	Smaller crystals were produced by ultrasonic treatment.
Hydrophilic Vegetable Gums	Disperses and solubilizes hydrophilic vegetable gums in water; makes dispersions of added particulate matter.
Intracellular Membrane	Disruption and particle size reduction obtained in 30-60 seconds.
Isoenzymes	Selectively activated with respect to time and intensity of treatment.
Kidney	1 gm disintegrates in 3 minutes.
Kidney Stones	Easily broken in seconds in vitro.
Klebsiella	Excellent disruption.
L. Arabinosis	Complete disruption to free virus in 2 minutes without injury.
Lactobacillus	0.5 gm in 15 ml completely disrupts in 11 minutes. Excellent release of acetokinase.
Lenconostoc Mesenteroides	Ultrasonic treatment for 15 minutes using high power for disruption.
Leukocyte Lysozyme Activity In Myelocytic Leukemia	The cell suspension was ultrasonically treated and samples assayed for lysozyme activity. The lysozyme concentration of the leukocytes ug/10 ⁶ cells was determined.
Linoleic Acid	Made suspension in water in 30 seconds.
Liver Tissue	1 gm homogenizes in less than 1 minute.
Lung Tissue	1 gm homogenizes in 2 minutes.
Lymphocytis	Complete disruption in 15 seconds.
Lymphocyte Nuclei	Complete disruption in 6 minutes.
Lymph Gland	Direct injection lymphography with a modified radiopaque emulsion was obtained by ultrasonic treatment in a functional procedure producing lymphatic structure detail.
Lysosomes	Released enzymes quickly.
Malaria Protozoa	Fast, excellent disruption.
Maple Bark Spores	Complete disruption in 14 minutes.
Measles	Disruption of virus antigen clumps present in infected cells on low power. Ultrasonic treatment increased antigen titer 4-8 fold.

Table A.3 Ultrasonic Irradiation on Various Biological Materials

Name	Description
Methanobacillus Omelianskii	1 gm cells wet wt/ml completely disintegrates in 2 minutes for assaying methane.
Microbacterium Lacticum	Ultrasonic treatment used for malate dehydrogenase extraction.
Micrococci	A 13 ml solution completely disrupts in 15 minutes.
Micrococcus Lactiliticus	75 ml of a 20% suspension was disintegrated in 15 minutes and a good yield of the enzyme Xanthine dehydrogenase extracted.
Mineral Rock	Excellent for cleaning surfaces between polishing stages.
Mitochondria	Separate from cells without injury. Mitochondria themselves can be broken with longer ultrasonic treatment. Inner membrane subunits also isolated.
Muscle Tissue	1 gm homogenized in 4 minutes; heart muscle in 6 minutes.
Mycobacteria	A 20 ml growing media completely disrupts in 14 minutes. Clumps break quickly. An immunological compound prepared.
Mycoplasma Antibody	A suspension of Campo-W cells treated for 5 minutes gave 12 lines with the sera in a gel diffusion test. The extract was estimated to contain 12.75 mg protein per ml by Blaret reaction.
Myeloma Tumor Cells	Complete disruption in 10 minutes, 30% disruption in 2 minutes.
Myleran	Made colloidal suspension and dissolved in approximately 1 minute.
N. Crassa	Nuclease was isolated and purified from conidial extracts after 5 minutes treatment.
Naegleri Gruberi	This free-living soil amoeba was treated ultrasonically to release subcellular infectious material.
Neurospora	40 ml, 4 minutes, produced more protein than freeze thawing for study of enzymatic synthesis of cystathionine.
Nocardia Ostenodes	Breaks clumps and disintegrates in less than 10 minutes.
Nucleoprotein	Extracted from tissue. May be degraded selectively.
Oil And Water Emulsions	Permanent, stable emulsions in a few seconds. Particle size reduced to less than micron (each case slightly different). Oil in water/water in oil phases can be obtained in same vessel.
Oyster Shell	Small, clean hole can be drilled with microtip in 3 minutes. No cracking is produced.
Paracolon	Excellent disruption.
Parasites	Separated from red blood cells in a few seconds.
Pasteurella Pestis	Complete disruption in 30 minutes using high power.
Penicillium	Complete disruption in 3 minutes.

Table A.3 Ultrasonic Irradiation on Various Biological Materials

Name	Description
Pesticides	Ultrasonic treatment resulted in a 16-fold improvement in the potency of the antigen used with Microcrystalline Cellulose as a thin-layer absorbent for chromatographic separation.
Phosphatidate Phosphohydrolase	The most potent inhibitors for this enzyme were obtained by making five dispersions with the Sonifier system.
Phospholipid Micelles	Produced stable preparations for an indefinite period.
Plant Cells	30% packed plant cells (W/V) and distilled water (depending on type) can be completely disrupted in 1-15 minutes.
Plant Tissue	1 gm dried tissue suspended in alcohol disintegrates in about 5 minutes.
Platelets	Complete disruption according to size from 20 seconds to 4 minutes.
Pneumococci	Preserved in formalin for several years; completely disrupts in 6 minutes.
Polio Virus	Excellent disruption of this most difficult virus.
Powders	Broken down to a small, relatively uniform particle size.
PPLO	Complete disruption in 2 minutes.
Propionobacteria	Releases sulfhydro groups intact; 70 ml of 20% suspension processed for 10 minutes.
Propionibacterium Shermanii	2 minutes for extraction of citrate synthase.
Proteus	Excellent disruption.
Pseudomonas Aeruginosa	Rapid, complete disintegration.
Pseudomonas Fluorescens	2 gm wet wt in 10 ml completely disrupts in 1 minute.
Pulmonary Cytodiagnosis	The mucous in sputum can be evenly dispersed, giving a quick representative sample of cells for cytologic examination. Cells are liberated from the mucous of sputum that had been immersed in 50% alcohol or a fixative.
Ragweed Pollen	15 ml dispersion completely disintegrates in 11 minutes.
Rat Bone	1/2 gm disintegrates in 4 minutes.
Rat Liver	Complete disruption in 3 minutes.
Rat Liver Mitochondria	Ultrasonic treatment has been used extensively for the varied research performed on this material. Disruption occurs in seconds.
Rat Skin	1 gm completely disintegrates in 4 minutes.

Table A.3 Ultrasonic Irradiation on Various Biological Materials

Name	Description
Red And White Blood Cells	Ultrasonic treatment breaks particle size to 100 Angstroms. Complete disruption in 1 minute. 25 gms/100 ml, saline or plasma, sample treated 15 seconds, 35% disruption. Adenosine triphosphate was shown to be membrane-bound by this method.
Reovirus	Dissociates cell-bound and aggregated virus. Maximum titer with 4 ml of virus was achieved in 2 minutes.
Retinal Outer Segments	Ultrasonic treatment breaks particles down to almost molecular size.
Rhodospseudomonis Palustris	Complete disruption in 4 minutes.
Rhodospirillum Rubrum	Excellent disruption in a few seconds.
Rimosus	Monocellular elements from surface-grown colonies obtained in 1 minute. Complete disruption in 5 minutes, 50% disruption in 2 minutes.
RNA	Rapid and thorough re-suspension of 9 TCA pellets during extractions.
Rocks	Excellent for disaggregation of sedimentary rock and for cleaning material rock surfaces between polishing stages.
S. Faecalis	Excellent disruption in 1 minute.
S. Fragilis	5 minutes yielded excellent release of galactokinase, more than any other method. Subcellular particles may be extracted or disrupted.
Saliva Glands	Complete disruption.
Salmonella	Various culture media or phosphate buffered saline disintegrated between 40 and 50% in 10-20 minutes. Sonifying was one step in an improved assay for enzyme thiogalactoside transacetylase.
Salmonella Typhimurium And Enteritidis	Bacteria were suspended in 1/300 volume of original culture, sonified for 4 minutes and centrifuged for 20 minutes at 20,000 g. Extracts were found to catalyze the synthesis of cytidine diphosphate 3, 6-dideoxyhexoses.
Scholasticism Mansion	Complete disruption.
Sedimentary Rock	Completely disperses flocs with the release of all bound silt and clay particles.
Sediments	Ultrasonic treatment disperses fine material permitting quick, neat separation of sand from silt and clay fractions.
Serial Number Restoration	Used in crime laboratories to restore obliterated serial numbers.

Table A.3 Ultrasonic Irradiation on Various Biological Materials

Name	Description
Serratia Marcescens	Complete breakdown of a concentrated solution in 1 minute.
Serum	Quickly homogenized.
Serum Cholinesterase	Activated by ultrasonic treatment. Different cholinesterase isoenzymes may be activated and inactivated selectively.
Shale	Excellent disaggregation of all fine-grained sedimentary rocks.
Shellfish	By drilling a clean hole with the microtip, various fluids or samples may be withdrawn or injected from living shellfish without destroying the animals.
Shigella	Quick disruption.
Skin	1 gm disintegrates in about 4 minutes. Epidermal homogenates that respire and utilize substrate can be extracted.
Soil	Separates solid particles without use of oxidants, acids or peptizing agents and yields stable suspensions.
Sperm (Human)	Tails are broken instantly. Heads are broken in 20 minutes.
Sputum	Cancer cells are more easily detected after ultrasonic treatment due to even dispersion of cells and sputum, and complete liberation of the cells from sputum.
Staphylococcus	A concentrated solution disrupts 98% in 10 minutes. With 1 gm cells wet wt, to 2 gm water, 54.5 mg/ml of protein was released.
Starch	Obtained by extracting from green plant leaf homogenate.
Streptococcus, Group A	A 20% suspension in a 15 ml solution completely disrupts in 15 minutes.
Streptomyces	Monocellular elements from surface-grown colonies obtained in 1 minute. Complete disruption in 5 minutes, 50% disruption in 2 minutes.
Subcellular Particles	May be separated or broken depending on power selection and length of time.
Sulfanilamide	Excellent dispersion in less than 1 minute. Continued ultrasonic treatment will produce complete disruption.
Sulfapyridine	Excellent dispersion in less than 1 minute. Continued ultrasonic treatment will produce complete disruption.
Synovial Fluid	Ultrasonic treatment is an excellent means of reducing fluid viscosity. It is simpler and faster than using hyaluronidase.
T. Pyriformi	Excellent disruption, 8 enzymes released.
Tablets	Complete disruption in 2-40 seconds, depending on type.
Tea	Excellent extraction.

Table A.3 Ultrasonic Irradiation on Various Biological Materials

Name	Description
Tetrahymena	Disrupts in a few seconds. Enzymes which have been monitored include: succinate, lactate, B-hydroxy butyrate, glutamate and DPNH oxidases, DPNH-cytochromeC, reductase and ribonuclease. Activity of DPNH oxidase was twice that of the best previous experiments.
Thermoactinomyces	Disruption of hyphae. Homogenization of protein complex without denaturation.
Thermophile Negative	Good disruption within 2 minutes.
Thermophilic Bacillus	Isocitrate lyase was extracted from a spore-forming bacillus similar to Stearothermophilus. A washed cell paste suspended in a phosphate buffer was sonified 1-2 minutes and the supernatant was used for enzyme experiments without further treatment. Extracts could be frozen and stored without loss of activity.
Thiouric Acid	Dissolved in a few seconds.
Thymus Cells	Complete disruption in 15 seconds.
Tissue Culture Cells	Complete disruption in a few seconds. To avoid damage to free organelles and to obtain intact lysosomes, use low power at short exposure.
Toxin And Antitoxin	One example of many: Toxin preparations of whole cell lysate (WCL) of the Inaba serotype strain 569E of the classic biotype of cholera vibrio were grown on 3% Bacto peptane agar and harvested in distilled water at 18 hours. The unwashed suspensions were solubilized ultrasonically, clarified by centrifugation and the supernate freeze-dried for the titration of cholare toxin in the rabbit ileal loop.
Toxoplasma Gondii	Can be separated form white blood cells without injury.
Transplantation Antigens	Were extracted from spleen, thymus and lymph nodes.
Trichomonas Foetus	Complete disruption in a few seconds.
Triolein	Complete stable emulsion in 2 minutes.
Trypanosomes	Concentrated 10 ml solution completely disrupts in 4 minutes.
Uterus Muscle	A 1/5 gm, 3 cc solution completely disrupts in 3 minutes for coenzyme Q determination.
Vaccines	Numerous advantages, such as more antigenic material released than usual, and the production of vaccines not obtainable by classified methods.
Various Bacilli	Complete disruption in 3 minutes.
Vibrio Comma	Excellent disruption.

Table A.3 Ultrasonic Irradiation on Various Biological Materials

Name	Description
Vibrio Extraction	Excellent for experimental vaccines. Evidence of breakage of virus/antibody bonds. Virus can be extracted without damage at low power, or broken at high power.
Vitamin E	30 seconds of ultrasonic treatment put material in solution with a resultant permanent suspension.
W138 Virus	Cell-free V-2 virus obtained in 30 seconds using 6 ml of Veronal buffer with W138 cells containing V-2 virus.
Yeast	Complete disruption in 3-10 minutes. Complete disruption of 9 grams pressed yeast in 18 ml buffer in 8 minutes. Protein release, 52 mg/ml from an aged sample.

Appendix B: Parts Lists

B.1	Replacement Parts	124
B.2	Optional Items	125
B.3	Sonifier System Kits	126

B.1 Replacement Parts

Table B.1 Replacement Parts List (250 W & 550 W)

Item	Description	EDP Number
Replacement Fuses	10 A (for Model 250, 117 V or 200-245 V)	200-049-112R
Cordsets	North America and Japan (100-120 V models)	200-030-013
	North America (200-245 V models)	CPN-030-007
	EU and South Korea (200-245 V CE models)	000-087-062
	China (200-245 models)	200-030-029
Stud	Replacement adaptor stud (horn to converter), 250 W & 550 W models	100-098-249
Converter	4C15 (CE compliant), 150 W models	101-135-126R
	102C Converter (CE compliant) 250 W & 550 W models	101-135-066R
	4C15HH (CE Compliant), 150W models	101-135-254R
Wrenches	Spanner, 150 W models	201-118-024
	Spanner	101-118-039
	Open-end	201-118-010
Mylar Washer	Kit Mylar Washer 20 kHz	100-063-357

B.2 Optional Items

Table B.2 Optional Items List

Item	Description	EDP Number
9-pin User I/O Cable	9-pin J911 cable, 15 ft for User I/O Port	101-240-015R
	9-pin J911 cable, 8.5 ft for User I/O Port	101-240-020R
Temperature Probe	1/4" plug connector	200-060-022R
1/2 Wave Horn Extension	Extends 1/2" diameter disruptor horn an additional 1/2 wavelength (approx. 5") at a 1/2" diameter	101-147-049

B.3 Sonifier System Kits

The following system Kits may be ordered. Each Kit contains the Sonifier powers supply for the indicated input voltage, converter, and horn as noted.x

Table B.3 Sonifier System Kits

Frequency	Power	Kit Description	EDP Number
40 kHz	150 W	Sonifier 150 system kit, 120 V, including 1/8" microtip.	101-063-962R
		Sonifier 150 system kit, 240 V CE, including 1/8" microtip.	101-063-963R
		Sonifier 150 system kit, 240 V, including 1/8" microtip.	101-063-964R
		Sonifier 150 system kit, 240 V CN, including 1/8" microtip.	101-063-1006R
20 kHz	250 W	Sonifier 250 system kit, 120 V, including 1/2" horn and tip.	101-063-965R
		Sonifier 250 system kit, 240 V CE, including 1/2" horn and tip.	101-063-966R
		Sonifier 250 system kit, 240 V, including 1/2" horn and tip.	101-063-967R
		Sonifier 250 system kit, 240 V CN, including 1/2" horn and tip.	101-063-1007R
20 kHz	550 W	Sonifier 550 system kit, 120 V, including 3/4" horn.	101-063-968R
		Sonifier 550 system kit, 120 V, including 1/2" horn and tip.	101-063-969R
		Sonifier 550 system kit, 240 V CE, including 3/4" horn.	101-063-970R
		Sonifier 550 system kit, 240 V CE, including 1/2" horn and tip.	101-063-971R
		Sonifier 550 system kit, 240 V, including 3/4" horn.	101-063-972R
		Sonifier 550 system kit, 240 V, including 1/2" horn and tip.	101-063-973R
		Sonifier 550 system kit, 240 V CN, including 3/4" horn.	101-063-1008R
		Sonifier 550 system kit, 240 V CN, including 1/2" horn and tip.	101-063-1009R

Appendix C: Accessories

C.1 Accessories..... 128

C.1 Accessories

Table C.1 Accessories List

Item	Description	EDP Number
Temperature Probe	The temperature probe can manage the temperature of the sample to within a user specific range, automatically adjusting the ultrasonic pulse length to regulate the temperature rise and prevent overheating.	200-060-022R
SFX150 Microtips	For processing of small volumes up to 100ml.	
	3/32" (2.4mm) 1ml & under	109-122-1066
	1/8" (3.2mm) 3-10ml	109-122-1065
	3/16" (4.8mm) 5-25ml	109-122-1182
	1/4" (6.4mm) 10-100ml	109-122-1064
	(4) 1/8" (3.2mm) on a 1" center horn for processing 4 samples	109-116-1566
Disruptor Horns	1/2" diameter stepped, w/grad. scale	101-147-036
	1/2" diameter stepped, tapped	101-147-037R
	1/2" diameter stepped, solid	101-147-038
	3/8" diameter stepped, solid	101-147-039
	1/2" diameter exponential, tapped	101-147-040
	1/2" diameter exponential, solid	101-147-041
	1/2" diameter catenoidal, solid	101-147-042
	3/4" diameter stepped, solid	101-147-043
	1" diameter stepped, solid	101-147-044
	3/4" diameter solid, high gain	101-147-035R
Cup Horns	Permits material to be treated while isolated in small test tubes. Cups have transparent plastic bodies. Horn is attached to converter and mounted upside down.	
	1" high density	101-147-046
	2" diameter	101-147-047
	3" diameter	101-147-048
	1" diameter, 150W model	1019-116-1760
Support Stand	Support stand	101-063-1108
	Converter clamp for SFX150	101-063-1109
	Converter clamp for SFX250 & SFX550	101-063-1110

Table C.1 Accessories List

Item	Description	EDP Number
Continuous Flow Attachment	Permits continuous processing of low-viscosity materials with rates up to 38 liters/hour. Designed primarily for emulsifying, dispersing, and homogenizing, this attachment will disrupt most cells, with the exception of the more difficult types. Materials being treated may be passed through the attachment more than once to obtain the desired results. A water jacket and input, output, and overflow connections are provided. For use with horns having outside threads.	100-146-171
Continuous Flow, Glass Rosett Cooling Cell	Cooling cell for continuous circulation of the substance being processed. The cell is equipped with intake and output connections for continuous processing and a double chamber for cooling. Normally, adequate cooling is achieved by connection to the cold water tap, or by using a closed-circuit system. An ice/salt water solution will maintain a temperature below 0°C. Borosilicate glass construction allows observation during treatment. Not suited for difficult cells.	201-123-004
Sealed Atmosphere Treatment Chambers	Used for batch treatment of infectious materials. Input and output connections allow filling and emptying without breaking the airtight seal and permit processing with an inert gas. Stainless steel.	
	3-10 ml	101-021-001
	6-15 ml	101-021-002
	25-50 ml	101-021-003
	Same as above 101-021-001 series, but with cooling water jacket. 3-10 ml	101-021-004
	6-15 ml	101-021-005
	25-50 ml	101-021-006
Flat Tip	Replacement for 1/2" horn, 1/4"-20 thread.	101-148-013

Table C.1 Accessories List

Item	Description	EDP Number
Tapered Microtips	For processing small volumes. Attaches to standard tapped disruptor horn. Tip amplitude is 3-1/2 times greater than that of standard horn. Recommended for difficult applications, such as spores, fungi, yeast, muscle and connective tissue. Excellent results on volumes ranging from 3 to 20ml in a comparatively short time.	
	1/8" diameter	101-148-062
	3/16" diameter	101-148-069
	1/4" diameter	101-148-070
Double-step Microtip Assembly	A two-piece horn consisting of a coupling section and a lower tip. The standard disruptor horn must be removed prior to using this tip. Recommended for use on extremely small volumes (0.5-20 ml). Applications include red and white blood cells, tissue culture cells, Hela cells. Overall length is 9-1/8" with 1/8" diameter in the lower 2-1/8". The double-step microtip is to be used only with coupler.	101-063-212
Double-step Microtips	Coupler section only	101-147-050
	Microtip section only	101-148-063
Rosett Cooling Cells	Borosilicate glass cell has conical shape with three arms to allow circulation of substance being processed. When the cell is immersed in a cooling bath, the enlarged glass surface areas, plus circulation through the arms, provide an effective means of heat exchange.	
	Model 25, 8-25 ml	201-123-001
	Model 50, 25-180 ml	201-123-002
	Model 250, 35-300 ml	201-123-003
Tissue Disruptor	Designed for disintegration of difficult tissues. Stainless steel construction. Cell bottom holds 6g of tissue. A water jacket is provided for cooling.	101-021-007
Soundproof Enclosure	Reduces mechanical noise generated during liquid processing to a normal level. Especially useful when using a cell disruptor for extended periods.	101-063-275
Soundproof Enclosure Adapter	Adapter needed for soundproof enclosure with 150W models.	100-121-074
Glass Beads	25 micron diameter	201-002-003
	35 micron diameter	201-002-005

Appendix D: Handheld Converter

D.1	Handheld Converter Overview	132
D.2	Handheld Converter Setup and Operation	134
D.3	Handheld Converter Ultrasonic Test.	136

D.1 Handheld Converter Overview

The SFX150 handheld converter is ergonomically designed for comfort, and ease of use, to enable ultrasonic processing of up to 150 W at 40 kHz for quiet operation. The converter's recessed pushbutton provides assurance against unintended activation, while its LED indicator provides visual feedback on the converter's operation, letting you know when ultrasonics are being delivered by illuminating during an ultrasonic cycle or by flashing on and off for System Error/Alarm conditions.

NOTICE

The handheld converter is only compatible with the SFX150 Sonifier power supply and SFX150 microtips.

NOTICE

SFX150 software version must be V1.3 or higher for proper handheld operation. If a previous version is installed, it must be upgraded before using the handheld converter.

To check the software version, verify Register 1, see [6.4 System Configuration Registers](#) for information on accessing the configuration registers. See [1.4 How to Contact Branson](#) for information on getting your software upgraded.

Figure D.1 Handheld Converter

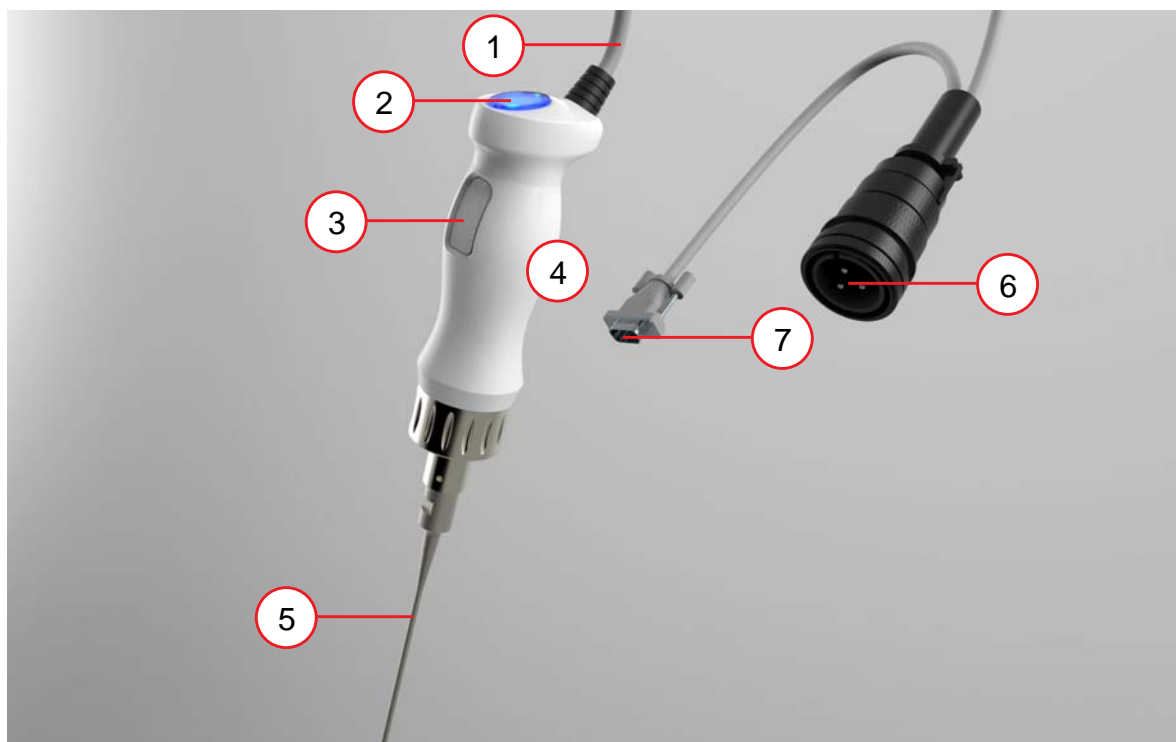

Table D.1 Handheld Converter

Item	Name	Description
1	Handheld Cable	Carries control and RF power signals.
2	LED Indicator	While illuminated, indicates that ultrasonic energy is being delivered to the converter. It also indicates that an Error/ Alarm occurred when a flashing pattern is displayed.
3	Start Pushbutton	Starts an ultrasonics cycle and must be maintained during the complete cycle. If released before completing the ultrasonic cycle, ultrasonics will immediately stop.
4	Handheld Grip Area	The area intended for you to grasp the converter. CAUTION Avoid contact with metal surfaces as they may become hot during prolonged operation
5	SFX150 Replaceable Microtip	Provide the mechanical vibrations to your liquid sample. CAUTION Do not touch the horn or tip when ultrasonics are active. Touching the horn or tip while the unit is on can result in serious personal injury (frictional burn).
6	RF Connector	Connects the Sonifier power supply RF power signal output to the handheld converter.
7	D-sub Connector	Connects handheld I/O Control signals to the Sonifier power supply.

D.2 Handheld Converter Setup and Operation

NOTICE

The handheld converter is only compatible with microtips. See [Table C.1 Accessories List](#) for more information.

NOTICE

Microtips are operated at high material stress levels. For this reason Amplitude is automatically limited to 70% for Handheld converters to mitigate the possibility of failure. To override this limit, change Register 17 to 0. See [6.4 System Configuration Registers](#) for more information.

To set up and operate the handheld converter, take the following steps:

Table D.2 Handheld Converter Setup and Operation

Item	Description
1	Ensure the Sonifier power supply is turned off.
2	Connect the microtip to the handheld converter: <ul style="list-style-type: none"> • Clean the contacting surfaces of the handheld converter and microtip, and remove any foreign matter from the threaded stud and threaded hole • Thread the handheld converter stud into the microtip and tighten, using wrenches. The recommended torque is 220 in·lb (24.85 N·m)
3	Connect the RF and D-sub cables to the Sonifier power supply as shown on Figure D.2 Handheld Converter Setup .
4	Turn on the power supply.
5	Select your desired operation mode.
6	Perform an ultrasonic test as described on D.3 Handheld Converter Ultrasonic Test .
7	Press the handheld converter pushbutton to start an ultrasonic cycle.

Figure D.2 Handheld Converter Setup



CAUTION	General Warning
	<p>Both the D-sub and RF connector must be connected and locked to ensure proper operation.</p>

NOTICE

In normal operation, the LED indicator will illuminate for the complete ultrasonic cycle. In pulsed sonic modes, the LED will remain on during both On and Off times.

NOTICE

If an Alarm/Error occurs, the LED indicator will flash on and off to alert you. Review the error code shown on the display and consult [7.4 Alarms/Errors](#) for more information. Press the reset key to reset Alarms/Errors.

D.3 Handheld Converter Ultrasonic Test

The Test key on the front panel of the Sonifier power supply is used to verify that the unit is functioning (providing ultrasonic energy to the converter and microtip). The test key on the power supply must be held, and then the pushbutton on the handheld converter must be pressed for the system to perform an ultrasonic test.

Before testing the Sonifier system, always make sure that the microtip is not touching anything. The system also performs several self-tests when it is first turned on.

Table D.3 Ultrasonic Test

Step	Do this...	To obtain this result
1	Set up the Sonifier system following the instructions in this appendix. If no microtip is currently installed, mount the microtip to the handheld converter. See D.2 Handheld Converter Setup and Operation for more information.	Prepare the Sonifier system to operate, if it was not previously assembled.
2	After you have connected the microtip to the handheld converter and verified all other connections are as indicated in Chapter 5: Installation and Setup , turn on the unit and observe the self-test displays.	Verify that the system passes all its self-tests, observing that there are no error messages on the front panel display. The Sonifier system advances to the ready (rdy) mode and shows 'rdy' on the display (see 2.2.1 Sonifier Power Supply Front Panel).
3	Adjust the Amplitude control to approximately 50% (observe the value on the front panel display). See Chapter 6: Operation to adjust the amplitude.	Ensures that ultrasonic amplitude will be at a mid-range value, and will not cause damage if you were using a microtip (which must be used at less than 70%).
4	Verify that the microtip is not touching anything. Press and hold the test key on the front panel of the power supply, then press the handheld converter pushbutton. Observe the front panel display.	Verifies the ultrasonic output of the system. You may hear a soft, high-pitched sound. The display will show the output power value. The test will run for 2 seconds, then stop.
5	If no alarms occurred during the Test, you may either proceed with using the system or turn the unit off. If an error occurs, see 7.4 Alarms/Errors for more information.	Verification that the Sonifier system is operating and is ready to be set up for your experiment or processing needs.

NOTICE

See [7.3 Troubleshooting Chart](#) if you have difficulties performing the above steps.

Index

Numerics

- 3 Pin RF Connector 22
- 9-pin User I/O Cable 125

A

- Accessories 31, 128, 131
- Aerosoling 108
- Alarm/Error Beeper 56
- Alarms/Errors 103
- Assembling 39
- Assembling the Equipment 39
- Auto Reset 56

B

- Back Panel Connections 22
- Biological Materials 111

C

- Cleaning 96
- Configuration Lock 56
- Connecting the Tip to the Horn 41
- Continuous Flow Attachment 129
- Continuous Power Rating 26
- Continuous Sonics Modes 51
- Continuous-Flow Attachment 35
- Control Modes 51
- Controls 16
- Converter 124
- Cordsets 124
- Cross-Contamination 109
- Cup Horn 34, 128
- Current Rating, Fuse 26

D

- Delivery and Handling 24
- Dimensions 27
- Discoloration 108
- Disrupting Tissues and Solids 110
- Disruptor Horns 128
- Double-step Microtips 130

E

- Electrical Connections to Equipment 44
- Electrical Specifications 26
- End of Total Cycle Beeper 56
- Environmental Specifications 26

F

- Flat Tip 129
- Flow-Thru Horn 35
- Flow-Thru Rosett Cell 36
- Foaming 108
- Front Panel 16
- Fuse Holder 22

G

- General Cleaning 96
- General Precautions 5
- Glass Beads 130
- Glass Powders 110
- Glass Rosett Cooling Cell 129
- Guards and Safety Equipment 46

H

- Height 27
- Horn Amplitudes 42
- Horn Tip Cleaning 99
- Humidity 26

I

- IEC/C14 Power Connector 22
- Indicators 16
- Input Power Requirements 43
- Input Voltage 26
- Installation 30
- Installation Checklist 30
- Intended Use of the System 6
- Interface 50

K

- Kits 126

L

- Lapping Procedure 99
- LCD Description 19
- LCD Icons 19
- Length 27
- Limiting Temperature Rise 106
- Load Preset 93

M

- Maintenance 96
- Mating Surfaces 98
- Maximum Temperature Modes 52
- Microtips 32
- Modes 51

O

- Operating Considerations 106
- Operating Temperature 26
- Optional Items 31, 125

Overload 103

P

Panel Trigger 55
Physical Description 27
Power Cord 44
Power Output Loss 97
Power Switch 22
Primary Control Modes 51
Pulse Start 55
Pulse Temperature Modes 53
Pulsed Sonics Modes 51

R

RAM 104
Reconditioning the Stack Interface 98
Refacing the Mating Surfaces 98
Regulatory Compliance 6
Replacement Fuses 124
Replacement Parts 124
Results 54
Rosett Cell 36
Rosett Cooling Cells 130

S

Safety Label 4
Safety Requirements and Warnings 2
Save Preset 92
Sealed Atmosphere Treatment Chambers 129
Seek @ Power Up 56
Setting up the Workplace 6
Setup Procedure 39
Software Version 55
Sonifier System Kits 126
Soundproof Enclosure 37, 130
Speed of Temperature Rise 107
Standard Components 31
Sterilizing 109
Storage Temperature 26
Stud 124
Stud Reinsertion 99
Symbols Found in this Manual 2
Symbols Found on the Product 4
System Component Description 31
System Configuration Registers 55
System Kits 126
System Restore 57

T

Tapered Microtips 130
Technical Specifications 26
Temperature Limit Modes 52
Temperature Probe 125
Temperature Probe Connection 44
Temperature Probe Connector 22

Temperature Rise 107
Temperature Units 57
Test 47, 136
Timeout 57
Tip Erosion 96
Tissue Disruptor 33, 130
Troubleshooting 96, 101

U

Ultrasonic Irradiation 111
Ultrasonic Test 47
Undesirable Factors 108
User I/O Cable 125
User I/O J2 Connector 22
User Interface 50

V

Vessel Capacity 107

W

Weigh 27
Width 27
Wrenches 124