

Instructions For Use

Allegra X-15R

Centrifuge

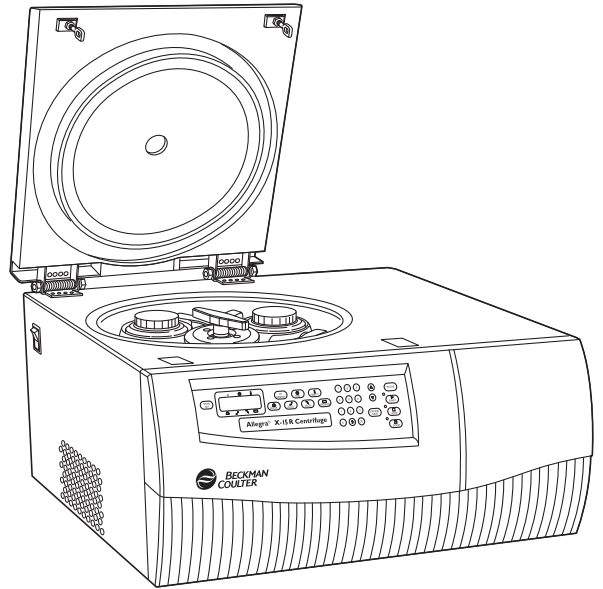

PN GXR-IM-4AC
October 2013



Beckman Coulter, Inc.
250 S. Kraemer Blvd.
Brea, CA 92821 U.S.A.



Allegra X-15R

Centrifuge

PN GXR-IM-4AC (October 2013)

© 2013 Beckman Coulter, Inc.

All rights reserved. No part of this document may be reproduced or transmitted in any form or by any means, electronic, mechanical, photocopying, recording, or otherwise, without prior written permission from Beckman Coulter, Inc.

Beckman Coulter, the stylized logo, and Allegra are trademarks of Beckman Coulter, Inc. and are registered in the USPTO.

All other trademarks, service marks, products, or services are trademarks or registered trademarks of their respective holders.

Find us on the World Wide Web at:

www.beckmancoulter.com

Made in U.S.A.

Printed in U.S.A.

Safety Notice

Read all product manuals and consult with Beckman Coulter-trained personnel before attempting to operate instrument. Do not attempt to perform any procedure before carefully reading all instructions. Always follow product labeling and manufacturer's recommendations. If in doubt as to how to proceed in any situation, contact your Beckman Coulter Representative.

Alerts for Warning, Caution, and Note



WARNING indicates a potentially hazardous situation which, if not avoided, could result in death or serious injury.



CAUTION indicates a potentially hazardous situation, which, if not avoided, may result in minor or moderate injury and/or mechanical damage.

NOTE NOTE is used to call attention to notable information that should be followed during installation, use, or servicing of this equipment.

Safety During Installation and/or Maintenance

This centrifuge weighs 128 kg (283 lb). Do not attempt to lift or move it without assistance.

Any servicing of this equipment that requires removal of any covers can expose parts that involve the risk of electric shock or personal injury. Make sure that the power switch is off and the centrifuge is disconnected from the main power source by removing the Mains (power) plug from the outlet receptacle, and refer such servicing to qualified personnel.

Do not replace any centrifuge components with parts not specified for use on this instrument.

Electrical Safety

To reduce the risk of electrical shock, this equipment uses a three-wire electrical cord and plug to connect the centrifuge to earth-ground. To preserve this safety feature:

- Make sure that the matching wall outlet receptacle is properly wired and earth-grounded. Check that the line voltage agrees with the voltage listed on the name-rating plate affixed to the centrifuge.
- Never use a three-to-two wire plug adapter.

Safety Notice

Safety Against Risk of Fire

- Never use a two-wire extension cord or a two-wire non-grounding type of multiple-outlet receptacle strip.

Do not place containers holding liquid on or near the chamber door. If they spill, liquid may get into the centrifuge and damage electrical or mechanical components.

Safety Against Risk of Fire

This centrifuge is not designed for use with materials capable of developing flammable or explosive vapors or hazardous chemical reactions. Do not centrifuge such materials (such as chloroform or ethyl alcohol) in this centrifuge nor handle or store them within the 30-cm (1-ft) area surrounding the centrifuge.

Mechanical Safety

For safe operation of the equipment, observe the following:

- Use only the rotors and accessories designed for use in this centrifuge.
- Do not exceed the maximum rated speed of the rotor in use.
- NEVER attempt to slow or stop the rotor by hand.
- Do not lift or move the centrifuge while the rotor is spinning.
- NEVER attempt to override the door interlock system while the rotor is spinning.
- Maintain a 7.6-cm (3-in.) clearance envelope around the centrifuge while it is running. During operation you should come within the envelope only to adjust instrument controls, if necessary. Never bring any flammable substances within the 30-cm (1-ft) area surrounding the centrifuge. Never lean on the centrifuge or place items on the centrifuge while it is operating.

Chemical and Biological Safety

Normal operation may involve the use of solutions and test samples that are pathogenic, toxic, or radioactive. Such materials should not be used in this centrifuge, however, unless *all necessary safety precautions are taken*.

- Observe all cautionary information printed on the original solution containers prior to their use.
- Handle body fluids with care because they can transmit disease. No known test offers complete assurance that they are free of micro-organisms. Some of the most virulent—Hepatitis (B and C) and HIV (I–V) viruses, atypical mycobacteria, and certain systemic fungi—further emphasize the need for aerosol protection. Handle other infectious samples according to good laboratory procedures and methods to prevent spread of disease. Because spills may generate aerosols, observe proper safety precautions for aerosol containment.

Do not run toxic, pathogenic, or radioactive materials in this centrifuge without taking

appropriate safety precautions. Biosafe containment should be used when Risk Group II materials (as identified in the World Health Organization *Laboratory Biosafety Manual*) are handled; materials of a higher group require more than one level of protection.

- Dispose of all waste solutions according to appropriate environmental health and safety guidelines.

It is your responsibility to decontaminate the centrifuge and accessories before requesting service by Beckman Coulter.

RoHS Notice

These labels and materials declaration table (the Table of Hazardous Substance's Name and Concentration) are to meet People's Republic of China Electronic Industry Standard SJ/T11364-2006 "Marking for Control of Pollution Caused by Electronic Information Products" requirements.

China RoHS Caution Label

This label indicates that the electronic information product contains certain toxic or hazardous substances. The center number is the Environmentally Friendly Useful Period (EFUP) date, and indicates the number of calendar years the product can be in operation. Upon the expiration of the EFUP, the product must be immediately recycled. The circling arrows indicate the product is recyclable. The date code on the label or product indicates the date of manufacture.



China RoHS Environmental Label

This label indicates that the electronic information product does not contain any toxic or hazardous substances. The center 'e' indicates the product is environmentally safe and does not have an Environmentally Friendly Useful Period (EFUP) date. Therefore, it can safely be used indefinitely. The circling arrows indicate the product is recyclable. The date code on the label or product indicates the date of manufacture.



	Safety Notice, iii
	Introduction, xiii
CHAPTER 1:	Description, 1-1
	Introduction, 1-1
	Centrifuge Function and Safety Features, 1-1
	Centrifuge Function, 1-1
	Safety Features, 1-2
	Centrifuge Chassis, 1-2
	Housing, 1-2
	Door, 1-3
	Rotor Chamber, 1-3
	Temperature Sensing and Control, 1-3
	Drive, 1-3
	Name Rating Plate, 1-3
	Controls and Indicators, 1-3
	Power Switch, 1-3
	Control Panel, 1-4
	Digital Displays, 1-4
	Run-Parameter Keys, 1-5
	Specifications, 1-7
	Available Rotors, 1-9
CHAPTER 2:	Operation, 2-1
	Introduction, 2-1
	Summary of Run Procedures, 2-2
	Manual Run, 2-2
	Programmed Run, 2-3
	Preparation, 2-3
	Installing the Rotor, 2-3
	Manual Operation, 2-4
	Selecting a Rotor, 2-5

- Entering Run Speed, 2-5
- Entering Run Time, 2-5
- Entering Run Temperature, 2-6
- Entering Acceleration and Deceleration Rates, 2-6
- Starting a Run, 2-7
- Pulse Function, 2-8
- Programmed Operation, 2-9
 - Creating a New Program, 2-9
 - Recalling a Program, 2-9
- Disabling/Enabling the Audible Tones, 2-10
- CHAPTER 3: Troubleshooting, 3-1**
 - Introduction, 3-1
 - User Messages, 3-1
 - Other Possible Problems, 3-4
 - Retrieving Your Sample in Case of Power Failure, 3-6
- CHAPTER 4: Care and Maintenance, 4-1**
 - Introduction, 4-1
 - Instrument Care, 4-1
 - Maintenance, 4-1
 - Cleaning, 4-2
 - Tube Breakage, 4-2
 - Decontamination, 4-3
 - Sterilization and Disinfection, 4-3
 - Circuit Breaker and Fuses, 4-3
 - Storage and Transport, 4-4
 - Storage, 4-4
 - Supply List, 4-4
 - Replacement Rotor Parts, 4-4
 - Other, 4-4
- APPENDIX A: Installation, A-1**
 - Introduction, A-1
 - Space and Location Requirements, A-1
 - Electrical Requirements, A-2
 - Securing the Centrifuge to the Bench, A-3
 - Test Run, A-4
- Beckman Coulter, Inc.

[Allegra X-15R Centrifuge Warranty](#)
[Related Documents](#)

Illustrations

- 1.1 The Centrifuge, 1-2
- 1.2 Control Panel, 1-4
- 3.1 Door Latch Override, 3-6
- A.1 Centrifuge Dimensions, A-2

Tables

- 2.1 Acceleration and Deceleration Rates (in Minutes:Seconds) to and from Maximum Speed, 2-7
- 3.1 Diagnostic Message Chart, 3-2
- 3.2 Troubleshooting Chart, 3-5

Certification

Beckman Coulter Allegra X-15R centrifuges are manufactured in a facility that maintains certifications to both ISO 9001:2008 and ISO 13485:2003. They have been designed and tested to be compliant (when used with Beckman Coulter rotors) with the laboratory equipment requirements of applicable regulatory agencies. Declarations of conformity and certificates of compliance are available at www.beckmancoulter.com.

Scope of Manual

This manual is designed to familiarize you with the Beckman Coulter Allegra X-15R centrifuge, its functions, specifications, operation, and routine operator care and maintenance. Beckman Coulter recommends that you read this entire manual, especially the *Safety Notice* and all safety-related information, before operating the centrifuge or performing instrument maintenance.

- [CHAPTER 1, Description](#) contains system specifications and a brief physical and functional description of the centrifuge, including the operating controls and indicators.
- [CHAPTER 2, Operation](#) contains centrifuge operating procedures.
- [CHAPTER 3, Troubleshooting](#) lists diagnostic messages and other possible malfunctions, together with probable causes and suggested corrective actions.
- [CHAPTER 4, Care and Maintenance](#) contains procedures for routine operator care and maintenance, as well as a brief list of supplies and replacement parts
- [APPENDIX A, Installation](#) provides requirements for preparing laboratory facilities and installing the centrifuge.

NOTE If the centrifuge is used in a manner other than specified in this manual, the safety and performance of this equipment could be impaired. Further, the use of any equipment other than that recommended by Beckman Coulter has not been evaluated for safety. Use of any equipment not specifically recommended in this manual and/or the applicable rotor manual is the sole responsibility of the user.

Conventions

Certain symbols are used in this manual to call out safety-related and other important information. These international symbols may also be displayed on the centrifuge and are reproduced on the inside of the back cover.

Typographic Conventions

Certain typographic conventions are used throughout this manual to distinguish names of user interface components, such as keys and displays.

- *Key names* (for example, **START** or **ROTOR**) appear in capital letters in boldface type.

CFC-Free Centrifugation

To ensure minimal environmental impact, no CFCs are used in the manufacture or operation of Allegra X-15R centrifuges.

Radio Interference

This equipment has been tested and found to comply with the limits for a Class A digital device, pursuant to Part 15 of FCC Rules. These limits are designed to provide reasonable protection against harmful interference when the equipment is operated in a commercial environment. This equipment generates, uses, and can radiate radio frequency energy and, if not installed and used in accordance with this instruction manual, may cause interference to radio communications. Operation of this equipment in a residential area is likely to cause interference, in which case the user will be required to correct the interference at his own expense.

Canadian Regulations

This equipment does not exceed the Class A limits for radio noise emissions from digital apparatus as set out in the radio interference regulations of the Canadian Department of Communications.

Le présent appareil numérique n'émet pas de bruits radioélectriques dépassant les limites applicables aux appareils numériques de Classe A prescrites dans le règlement sur le brouillage radioélectrique édicté par le Ministère des Communications du Canada.

Recycling Label



This symbol is required in accordance with the Waste Electrical and Electronic Equipment (WEEE) Directive of the European Union. The presence of this marking on the product indicates:

1. the device was put on the European market after August 13, 2005 and
2. the device is not to be disposed via the municipal waste collection system of any member state of the European Union.

It is very important that customers understand and follow all laws regarding the proper decontamination and safe disposal of electrical equipment. For Beckman Coulter products bearing this label please contact your dealer or local Beckman Coulter office for details on the take back program that will facilitate the proper collection, treatment, recovery, recycling and safe disposal of the device.

Description

Introduction

This chapter provides a brief physical and functional description of the Beckman Coulter Allegra X-15R centrifuge. The operating controls and indicators are also described; instructions for their use are in [CHAPTER 2, Operation](#). Chemical compatibilities of materials listed in this manual can be found in Chemical Resistances (publication IN-175). Refer to the applicable rotor manuals for rotor descriptions.

Centrifuge Function and Safety Features

Centrifuge Function

The Beckman Coulter Allegra X-15R centrifuge (see [Figure 1.1](#)) is a refrigerated benchtop centrifuge that generates centrifugal forces required for a wide variety of applications. Together with the Beckman Coulter rotors designed for use in this centrifuge, the centrifuge applications include:

- Routine processing such as sample preparations, pelleting, extractions, purifications, concentrations, phase separations, receptor binding, and column centrifugations.
- Cell isolation.
- Binding studies and separation of whole blood.
- Processing large numbers of small-volume samples in multiwell plates for concentrating tissue-culture cells, cloning and replicate studies, in-vitro cytotoxicity studies, receptor binding, and genetic engineering experimentation.
- Rapid sedimentation of protein precipitates, large particles, and cell debris.

The Allegra X-15R is microprocessor-controlled, providing interactive operation. The instrument design features a brushless asynchronous motor, automatic rotor identification system, program memory that enables repeated run conditions, temperature control system, and a choice of acceleration and deceleration rates. User messages alert the operator to conditions that may need attention.

Figure 1.1 The Centrifuge

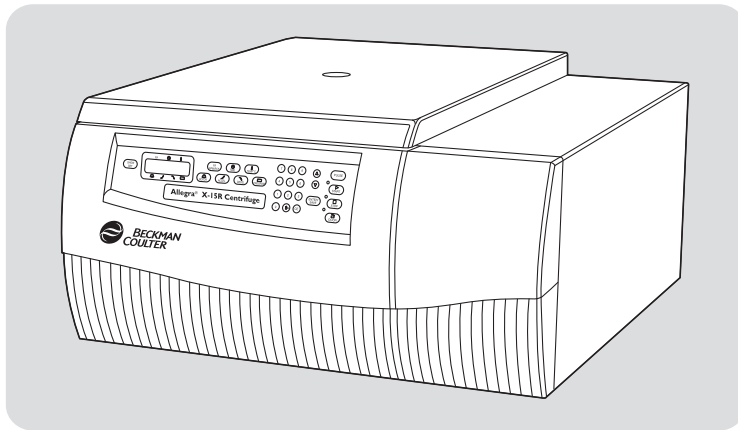

Safety Features

The Allegra X-15R centrifuge has been designed and tested to operate safely indoors at altitudes up to 2000 m (6562 ft). Safety features include the following.

- An electromechanical door lock system prevents operator contact with spinning rotors and prevents run initiation unless the door is shut and locked. The door is locked when a run is in progress and can be opened only when the rotor is stopped and the LED (light-emitting diode) next to the **DOOR** key is lit. If there is a power failure, the door lock can be manually tripped for sample recovery.
- A steel barrier surrounds the rotor chamber to provide full operator protection.
- A rotor identification system prevents the installed rotor from running above its maximum rated speed. During acceleration the microprocessor checks the magnetic rotor identification. Speed is limited to the maximum safe speed of the identified rotor. If the system identifies a rotor different than the one entered by the user, the system displays an error message and reduces the speed to the maximum allowable speed of the rotor.
- An imbalance detector monitors the rotor during the run, causing automatic shutdown if rotor loads are severely out of balance. At low speeds, an incorrectly loaded rotor can cause imbalance. Rotor instability can also occur if the centrifuge is moved while running, or if it is not resting on a level and secure surface (see [CHAPTER 3, Troubleshooting](#)).

Centrifuge Chassis

Housing

The centrifuge housing is made of sheet steel and structural foam and is finished with acrylic baking enamel. The control panel overlay is made of coated polystyrene copolymer.

Door

The aluminum and structural foam door is secured to the housing by solid hinges. A window in the center allows strobe viewing. When the door is closed, the locking system engages. The door is locked when a run is in progress and can be opened only when the rotor is stopped and the LED next to the **DOOR** key is lit. If there is a power failure, the door lock can be manually tripped for sample recovery (see [CHAPTER 3, Troubleshooting](#)).

Rotor Chamber

The aluminum rotor chamber is coated with epoxy enamel for corrosion resistance. The chamber is sealed by a foam gasket.

Temperature Sensing and Control

With the power on, the temperature control system is activated when the door is closed and locked. A sensor in the rotor chamber continuously monitors chamber temperature. The microprocessor calculates the required chamber temperature to maintain the selected rotor temperature. Run temperature can be set between -10 and $+40^{\circ}\text{C}$.

NOTE To avoid chamber icing, refrigeration is off when the door is open. The centrifuge door must be closed and locked for the refrigeration system to begin operating.

Drive

The asynchronous direct-drive motor is brushless for clean, quiet operation. The resilient suspension ensures that loads will not be disturbed by vibration, and prevents damage to the drive shaft if an imbalance occurs during centrifugation. Maximum acceleration and deceleration may be selected to allow fast processing of samples; alternately, delicate gradients may be preserved using slower acceleration and deceleration.

Name Rating Plate

A name rating plate is affixed to the rear of the instrument. Always mention the serial number and model number when contacting Beckman Coulter regarding your centrifuge.

Controls and Indicators

Power Switch

The power switch, located on the left side of the centrifuge, controls electrical power to the centrifuge. It is also a circuit breaker that will trip to cut off power in the event of a power overload. The power switch must be turned on before the chamber door can be opened.

Control Panel

The control panel (see [Figure 1.2](#)) is mounted at an angle on the centrifuge front for easy visibility and access. It is used to enter run parameters via function keys and a keypad, and to display run parameters, program information, and user messages.

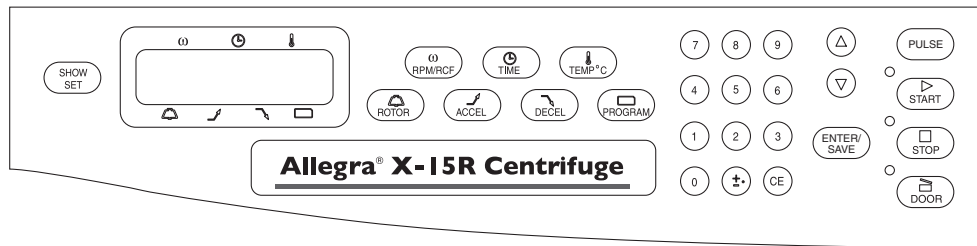

Figure 1.2 Control Panel







Digital Displays

The displays provide run information, user messages, and diagnostics.





- During a run, they show the actual (real-time) operating conditions.
- When the run parameters are being entered, they show the set values selected. Set values can be recalled during operation by pressing **SHOW SET**. After 5 seconds, the displays return to actual conditions.
- Error messages (see [CHAPTER 3, Troubleshooting](#)) also appear on the displays, when applicable. The centrifuge emits a series of audible tones to alert the user to an error condition. (Instructions for disabling the tones are in [CHAPTER 2, Operation](#).)











 SPEED	Indicates rotor speed in revolutions per minute (RPM) or in relative centrifugal field, a term describing the ratio of the centrifugal acceleration at a specified radius and speed to the standard acceleration of gravity ($RCF \times g$).
 TIME	<ul style="list-style-type: none"> • In a timed run, indicates the remaining run time in hours and minutes. The time display begins counting down when ENTER/SAVE then START is pressed and continues counting down to 0. The run automatically ends when the set time reaches 0 and deceleration begins (a tone sounds when the rotor stops spinning). If a malfunction shuts down the centrifuge during a run, when the instrument is turned back on the time will not remain and 00:00 will be displayed in the time window. By comparing this time with the original set time, you can determine when the run ended. • In a hold run, indicates the time elapsed since START was pressed. After 99 hours and 59 minutes the timer resets to 0 and continues counting elapsed time. • In a pulse (momentary) run, indicates the time (in minutes and seconds) elapsed since PULSE was pressed. Time continues to count up until the PULSE key is released. The total elapsed time is then displayed until another key is pressed.
 TEMPERATURE	Indicates rotor temperature in degrees C at thermoequilibrium.

 ROTOR	Displays the name of the selected rotor.
 ACCEL	When the ACCEL key is pressed, one of ten available acceleration rates can be entered. Displays the selected acceleration rate throughout the run.
 DECEL	When the DECEL key is pressed, one of eleven available deceleration rates can be entered. Displays the selected deceleration rate throughout the run.
 PROGRAM	<ul style="list-style-type: none"> • During setup—when the PROGRAM key is pressed, a program number (one of ten possible) can be selected and program parameters entered. • During centrifugation—the number of the program being run is displayed.

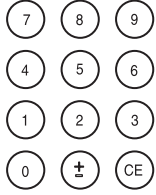
Run-Parameter Keys

Run-parameter keys are used to enter specific run information as follows. The centrifuge emits an audible tone when each key is pressed. (Instructions for disabling the tone are in [CHAPTER 2, Operation](#)).

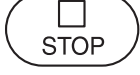
 ROTOR	Pressed to display scrollable list of compatible rotors. Can be pressed repeatedly to scroll through the rotor list (or the arrow keys can be used for scrolling).
 RPM/RCF	If the display shows speed in RPM, the key is pressed once to enter run speed (using the keypad) in RPM (revolutions per minute); pressed twice to enter run speed in RCF (relative centrifugal field). If the display shows speed in RCF, the key is pressed once to enter speed in RCF or twice to enter speed in RPM.
 TIME	<p>Pressed to enter run time using the keypad. When TIME is pressed twice, HOLD mode is selected. (Pressing it again reverts to time-entry mode.)</p> <ul style="list-style-type: none"> • Timed run—Run time up to 99 hours and 59 minutes can be set. If more than 59 minutes are entered in the minutes field, the system automatically converts the entry to hours and minutes. Deceleration begins when the set time counts down to 0. • Continuous run (hold)—For runs of unspecified lengths, hold mode is used. When 99 hours, 59 minutes is reached, the system resets to 0 and continues counting. A hold run continues until the STOP key is pressed.
 TEMP °C	Pressed to enter temperature (using the keypad), from -10 to +40°C. If a new temperature is not entered, the centrifuge uses the temperature set for the previous run.
 ACCEL	Enables selection of one of ten preset acceleration rates (see Table 2.1 in CHAPTER 2, Operation) available to protect specific gradient and sample-to-gradient interfaces. If no acceleration rate is selected, the centrifuge defaults to maximum acceleration.

	<p>Enables selection of one of eleven preset deceleration rates (see Table 2.1 in CHAPTER 2, Operation) available to maintain optimum separation. If no deceleration rate is selected, the centrifuge defaults to maximum deceleration. (Deceleration rate 0 is always coast to complete stop.)</p>
	<p>A toggle switch used to enter into and exit out of the program mode to create or recall programs. When the key is pressed, the program number can be selected using the keypad or arrow keys.</p>
	<p>Up and down arrow keys, which can be pressed to increment parameter values up or down.</p>
	<p>The ENTER/SAVE key can be pressed to save parameter inputs to system memory during manual run setup or to a program during a program set up, and to start the centrifuge (ENTER/SAVE, then START must be pressed to start the centrifuge).</p>
	<p>The keypad is used to enter numerical run parameters, to enter or recall a program number, and to select acceleration and/or deceleration rates. In addition to keys 0 through 9, the keypad includes a plus/minus key and a CE (clear entry) key.</p> <p>The \pm key is used to enter a temperature setting below 0°C (for example, -2°C).</p> <p>The CE (clear entry) key clears any parameter on the display. Pressing CE will also clear some diagnostic messages. If a diagnostic message does not clear when CE is pressed, see CHAPTER 3, Troubleshooting.</p>
	<p>Pressed during a run to display set values for 5 seconds.</p>
	<p>Causes the rotor to accelerate, at maximum rate, to set speed for short-duration runs (as long as the key is pressed). Deceleration, at maximum rate, begins when the key is released.</p>
	<p>Pressing ENTER/SAVE, then START begins the run. (START must be pressed within 5 seconds of pressing ENTER/SAVE.) This key combination can also be used to abort a deceleration process and restart the centrifuge.</p>
	<p>Can be pressed at any time while the rotor is spinning to terminate a run. The centrifuge decelerates to a complete stop according to the deceleration setting. The green light next to the key flashes while the rotor decelerates. A tone sounds when the rotor comes to a complete stop. (Instructions for disabling the tone are in CHAPTER 2, Operation.)</p>
	<p>Unlocks and opens the door. (The instrument will not accept the unlock command if the rotor is spinning.)</p>

Specifications

Only values with tolerances or limits are guaranteed data. Values without tolerances are informative data, without guarantee.

Specifications	Description
Speed	<ul style="list-style-type: none"> • Set Speed <ul style="list-style-type: none"> — 200 to 10,200 RPM in 10-RPM increments • Speed display <ul style="list-style-type: none"> — actual rotor speed in 10-RPM increments or in RCF (when selected)
Time	<ul style="list-style-type: none"> • Set time <ul style="list-style-type: none"> — to 99 hours 59 minutes or continuous (hold) • Time display <ul style="list-style-type: none"> — <i>Timed run</i>: indicates run time remaining — <i>Continuous (hold) or pulse run</i>: indicates elapsed time
Temperature	<ul style="list-style-type: none"> • Set temperature <ul style="list-style-type: none"> — -10 to +40°C in 1° increments • Temperature control (after equilibration) <ul style="list-style-type: none"> — $\pm 2^\circ\text{C}$ of set temperature^a • Temperature display (after equilibration) <ul style="list-style-type: none"> — chamber temperature in 1° increments • Ambient temperature range <ul style="list-style-type: none"> — 10 to 35° • Ambient temperature range for optimum operation <ul style="list-style-type: none"> — 10 to 25°C
Humidity restrictions	<75% (noncondensing)
Acceleration	10 acceleration rates
Deceleration	11 deceleration rates
Dimensions	<ul style="list-style-type: none"> • Width <ul style="list-style-type: none"> — 76.2 cm (30.0 in.) • Depth <ul style="list-style-type: none"> — 62.2 cm (24.5 in.) • Height <ul style="list-style-type: none"> — 34.3 cm (13.5 in.)
Weight	128 kg (283 lb)
Ventilation clearances (sides and rear)	7.6 cm (3.0 in.)
Finishes	<ul style="list-style-type: none"> • Control panel <ul style="list-style-type: none"> — coated polystyrene copolymer • Housing surfaces <ul style="list-style-type: none"> — acrylic baking enamel

Specifications	Description
Electrical requirements	<ul style="list-style-type: none"> • 208-V, 60-Hz instrument — 187–229 VAC, 12 A, 60 Hz • 220-V, 60-Hz instrument — 198–242 VAC, 12 A, 60 Hz • 200-V, 50/60-Hz instrument — 180–220 VAC, 12 A, 50/60 Hz • 230-V, 50-Hz instrument — 207–253 VAC, 12 A, 50 Hz
Electrical supply	Class I
Maximum heat dissipation into room under steady-state conditions	6800 Btu/hr (2 kW)
Noise level 0.91 m (3 ft) in front of centrifuge	≤ 68 dBa
Installation (overvoltage) category	II
Pollution degree	2 ^b

- a. During transient conditions, such as acceleration and deceleration, rotor temperature may be outside this range. To reach temperatures above ambient, the centrifuge is dependent on the frictional heat generated inside the chamber during operation. At low run speeds or low ambient temperatures, the centrifuge may not be able to achieve some higher temperatures.
- b. Normally only nonconductive pollution occurs; occasionally, however, a temporary conductivity caused by condensation must be expected.

Available Rotors

The following Beckman Coulter rotors can be used in the Allegra X-15R centrifuge. The rotors are described in individual manuals that accompany each rotor.

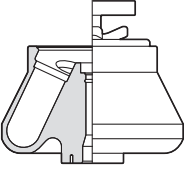
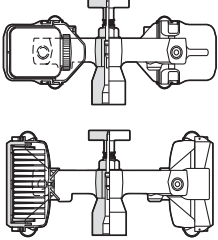
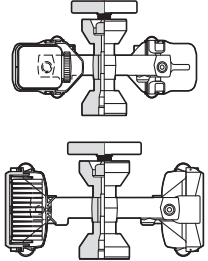
Rotor Profile	Description	Rotor Selection Code	Max RPM ^a	Max RCF ^b ($\times g$) at r_{\max}	Number of Tubes \times Nominal Capacity	Rotor Manual Number
	FX6100 Fixed Angle $r_{\max} = 98.0$ mm	FX6100	10,200	11,400	6 \times 100 mL	GX-TB-005
	SX4750 Swinging Bucket Tube-and-bottle buckets, $r_{\max} = 207.8$ mm Multiwell-plate carriers, $r_{\max} = 183.2$ mm	SX4750 SX4750 μ	4750 4450	5250 4060	4 \times 750 mL 4 \times 96 mL	GX-TB-003
	SX4750A Swinging Bucket (ARIES) Tube-and-bottle buckets, $r_{\max} = 207.8$ mm Multiwell-plate carriers, $r_{\max} = 183.2$ mm	SX4750A SX4750A	4750 4450	5250 4060	4 \times 750 mL 4 \times 96 mL	GX-TB-004

- Maximum speeds are based on a solution density of 1.2 g/mL. At upper temperature and humidity ambient conditions, swinging bucket rotor speed may require reduction.
- Relative Centrifugal Field (RCF) is the ratio of the centrifugal acceleration at a specified radius and speed (rw^2) to the standard acceleration of gravity (g) according to the following formula: $RCF = rw^2/g$ — where r is the radius in millimeters, w is the angular velocity in radians per second (2π RPM/60), and g is the standard acceleration of gravity (9807 mm/s²). After substitution: $RCF = 1.12 r (RPM/1000)^2$.

Description
Available Rotors

Introduction

This section contains centrifuge operating procedures. A summary is provided at the start of this section. If you are an experienced user of this centrifuge, you can turn to the summary for a quick review of operating steps. Refer to the applicable rotor manual for instructions on preparing the rotor for centrifugation.

 **WARNING**

Handle body fluids with care because they can transmit disease. No known test offers complete assurance that they are free of micro-organisms. Some of the most virulent—Hepatitis (B and C) and HIV (I-V) viruses, atypical mycobacteria, and certain systemic fungi—further emphasize the need for aerosol protection. Handle other infectious samples according to good laboratory procedures and methods to prevent spread of disease. Because spills may generate aerosols, observe proper safety precautions for aerosol containment.

Do not run toxic, pathogenic, or radioactive materials in this centrifuge without taking appropriate safety precautions. Biosafe containment should be used when Risk Group II materials (as identified in the World Health Organization *Laboratory Biosafety Manual*) are handled; materials of a higher group require more than one level of protection.

Do not use the centrifuge in the vicinity of flammable liquids or vapors, and do not run such materials in the instrument. Do not lean on the centrifuge or place items on it while it is operating.

Summary of Run Procedures

For runs at other than room temperature, refrigerate or warm the rotor beforehand for fast equilibration.

Manual Run

- 1 Turn the power switch on (I).
- 2 Press **DOOR** to open the chamber door; lift the door open.
- 3 Install the rotor according to the applicable rotor manual, then close the chamber door.
- 4 Press **ROTOR**, then press **ROTOR** again or use the arrow keys to select the rotor.
- 5 Press **RPM/RCF**, then use the keypad to enter the run speed. Press **RPM/RCF** a second time to toggle between RPM and RCF modes.
- 6 Press **TIME**, then use the keypad to enter the run time (to 99 hrs, 59 minutes); or press **TIME** twice to toggle between hold (continuous) run and set time mode.
- 7 Press **TEMP °C**, then use the keypad to enter the required run temperature -10 to +40°C.
- 8 Press **ACCEL**, then use the keypad or arrow keys to enter the selected acceleration rate number, 1 (**SLOW**) through 10 (**MAX**).
- 9 Press **DECEL**, then use the keypad or arrow keys to enter the selected deceleration rate number, 0 (**OFF**) through 10 (**MAX**).
- 10 Check that all parameters are correct and that the door is closed (door LED will be lit). Press **ENTER/SAVE**, then press **START** (within 5 seconds).
- 11 Wait for the set time to count down to zero, or end the run by pressing **STOP**.
- 12 When the rotor stops (a tone sounds and the **DOOR LED** lights), press **DOOR** to open the chamber door; lift the door.

Programmed Run

- 1 Turn the power switch on (I).
- 2 Press **DOOR** to open the chamber door.
- 3 Install the rotor according to the applicable rotor manual, then close the chamber door.
- 4 Press **PROGRAM**, use the keypad or arrow keys to enter the required program number, then press **ENTER/SAVE**.
- 5 Check that all parameters are correct and that the door is closed (door LED will be lit). Press **ENTER/SAVE**, then press **START** (within 5 seconds).
- 6 Wait for the run to end, or end the run by pressing **STOP**.
- 7 When the rotor stops (a tone sounds and the **DOOR** LED lights), press **DOOR** to open the chamber door; lift the door.

Preparation

Prepare the rotor for centrifugation as described in the applicable rotor manual. *For runs at other than room temperature, refrigerate or warm the rotor beforehand for fast equilibration.*

Installing the Rotor

The power must be turned on before you can unlock and open the chamber door. (To end a run for any reason, do not turn the power switch off; press **STOP** instead.)

- 1 Turn the power switch on.
The control panel display shows “**Allegra X-15R**” and the software version.
- 2 Press **DOOR**.
The centrifuge will accept this command only when the rotor is at rest and the **DOOR** LED is lit. The door opens and the LED goes out.

-
- 3** Install the rotor according to directions in the rotor manual.
Ensure that the rotor is seated on the drive hub.
Avoid bumping the control panel keys during rotor installation or removal.
-
- 4** Close the chamber door by pressing down firmly on both sides.
The door locks.
When the latches engage, the LED next to the **DOOR** key lights up.
-

Manual Operation

NOTE When using multiwell-plate carriers on the SX4750 rotor, enter SX4750 μ as the rotor, when using multiwell-plate carriers on the SX4750A rotor, enter SX4750A as the rotor and limit max speed of the instrument to 4450 RPM (when running up to three stacked Beckman Coulter plates separated by cap strips; reduce speed to 2700 RPM if running four stacked plates).

Set rotor speed using RPM values only. To set speed to a specific RCF, use the RPM-to-RCF conversion chart (GX-TB-015) to determine the applicable RPM to enter.

-
- 1** When a run-parameter key (**ROTOR**, **RPM/RCF**, **TIME**, **TEMP**, **ACCEL**, or **DECEL**) is pressed, a parameter can be entered or changed.
Entry is completed when **ENTER/SAVE** or another function key is pressed.
-
- 2** To change an entry before you've pressed **ENTER/SAVE** or another parameter key, enter a different value.
 - a.** Press **CE** to abort changes and start over.
 - b.** To change an entry after you've pressed **ENTER/SAVE**, press the run-parameter key again.
-
- 3** If an unacceptable value is entered, an out of range message is displayed in the message line.
Enter the correct value.
-

Selecting a Rotor

- 1 Press **ROTOR**, then use the arrow keys or press **ROTOR** again to select a rotor.
- 2 Press the next run-parameter key or press **ENTER/SAVE**.

Entering Run Speed

Enter a run speed up to the maximum speed of the rotor in use. Or, enter a relative centrifugal field (RCF) value up to the maximum achievable RCF of the rotor.

- 1 Press **RPM/RCF** once to enter speed in RPM. Press **RPM/RCF** again to toggle between **RPM** and **RCF** modes.
Allowed speed range for the selected rotor is displayed.
- 2 Use the keypad to enter required speed.
Entered speed appears on the speed display.
(If the entered speed is out of the speed range of the installed rotor, an error message will appear and the input will be cleared.)
Enter an acceptable value from the range displayed.
- 3 Press the next run-parameter key or **ENTER/SAVE**.
The rotor will accelerate or decelerate to the new speed.
You can change the set speed at any time during a run by repeating steps 1 through 3.

Entering Run Time

Run time can be set for up to 99 hours and 59 minutes or for a hold (continuous) run. The time display begins counting down when the rotor starts to spin. For a timed run, the run automatically terminates when the set time reaches zero and deceleration begins at the selected rate; a tone sounds when the rotor has stopped. For a hold run, the elapsed time is displayed and the run continues until **STOP** is pressed.

- 1 Press **TIME**.
If **HOLD** is displayed, press **TIME** again to enter time.

-
- 2 Use the keypad or arrow keys to enter required time.
Entered time appears on the display.
If you entered a number higher than 59 minutes, the centrifuge automatically recalculates the time in hours and minutes.
or
Press **TIME** again for a hold run.
HOLD appears on the display.
-
- 3 Press the next run-parameter key or **ENTER/SAVE**.
-

Entering Run Temperature

Run temperature can be set from -10 to $+40^{\circ}\text{C}$. If no value is entered, the centrifuge selects the last entered temperature.

-
- 1 Press **TEMP**.
The cursor and the temperature range (-10 to 40°C) appear.
-
- 2 Use the keypad or arrow keys to enter required temperature.
Entered temperature appears on the display.
(If the entered temperature is outside the valid temperature range, an error message will appear and the input will be cleared.)
Enter a valid temperature.
-
- 3 Press the next run-parameter key or **ENTER/SAVE**.
-

Entering Acceleration and Deceleration Rates

You can select one of ten acceleration rates and eleven deceleration rates to protect the gradient and sample-to-gradient interface. Select rates depending on the type of run you are performing—for pelleting runs, where sample mixing is not a concern, maximum acceleration and deceleration can be used. If running delicate gradients, a lower setting may be needed. Typical acceleration and deceleration rates are listed in [Table 2.1](#). If no rate is selected, the centrifuge automatically accelerates and decelerates at maximum.

Table 2.1 Acceleration and Deceleration Rates (in Minutes:Seconds) to and from Maximum Speed^a

Rate	SX4750		SX4750 μ		SX4750A		FX6100	
	(4750 RPM)		(4450 RPM)		(4750 RPM)		(10,200 RPM)	
	Accel	Decel	Accel	Decel	Accel	Decel	Accel	Decel
10 (MAX)	1:27	1:29	1:21	1:25	1:27	1:29	1:25	1:26
9	2:17	2:19	2:08	2:12	2:17	2:21	2:24	2:27
8	2:31	2:34	2:19	2:24	2:30	2:36	3:27	3:28
7	2:46	2:48	2:34	2:41	2:45	2:51	4:31	4:25
6	3:04	3:11	2:52	2:57	3:04	3:08	5:32	5:27
5	3:30	3:34	3:15	3:21	3:29	3:34	6:33	6:30
4	4:02	4:08	3:46	3:55	4:02	4:08	7:23	7:29
3	4:49	4:57	4:30	4:35	4:49	4:54	8:35	8:32
2	5:58	6:05	5:35	5:44	5:59	6:04	9:38	9:31
1 (SLOW)	7:55	8:04	7:23	7:37	7:55	8:03	10:08	10:04
0 (OFF)	—	15:34	—	14:22	—	16:20	—	17:18

a. Times shown are with the rotor fully loaded in the Allegra X-15R. (Times are approximate; actual times will vary depending on the rotor in use, the rotor load, run speed, and voltage fluctuations.)

- 1 Press **ACCEL**, then use the keypad or arrow keys to select the required acceleration rate.
Entered acceleration rate appears on the display.

- 2 Press the next run-parameter key or **ENTER/SAVE**.

- 3 Press **DECEL**, then use the keypad or arrow keys to select the required deceleration rate.
Entered deceleration rate appears on the display.

- 4 Press the next run-parameter key or **ENTER/SAVE**.

Starting a Run

NOTE Wipe out moisture from the chamber and the chamber gasket before each run.

1 Press **ENTER/SAVE** and **START**.

The light next to the **START** key flashes and the rotor begins to spin.

NOTE To begin a run, **ENTER/SAVE** must always be the last key pressed before pressing **START**. If you wait more than 5 seconds, the **START** key will not activate. If this happens, press **ENTER/SAVE** and **START** again to begin the run.

The run will end when the time display counts down to zero.

Press **STOP** to terminate a run for any reason.

- The green light next to the **STOP** key will flash while the rotor decelerates.
- A tone sounds when the rotor comes to a complete stop.

(Instructions for disabling the tone are at the end of this section.)

2 After the rotor has stopped and the LED lights, press **DOOR**.

The door opens.

3 Remove the rotor (or containers).



If disassembly reveals evidence of leakage, you should assume that some fluid escaped the rotor. Apply appropriate decontamination procedures to the centrifuge and accessories.

NOTE Depending upon the duration of the event, transient power-line interruptions may cause this equipment to decelerate or reset with the possible loss of in-process operation. If you suspect this has occurred, simply repeat the runs.

Pulse Function

The pulse function, accessed by pressing the **PULSE** key, is used for short-duration runs as follows.

- When the **PULSE** key is pressed, the rotor accelerates at maximum rate to the set speed and continues to spin as long as the **PULSE** key is pressed. (The current run time, acceleration, and deceleration settings are overridden by the pulse function.) When the **PULSE** key is released, the rotor begins decelerating to 0 RPM using maximum deceleration. Using the pulse function eliminates the need to press the **START** and **STOP** keys.
- When the **PULSE** key is pressed, the **TIME** display begins displaying the elapsed seconds. When the **PULSE** key is released, the seconds stop accumulating.
- The centrifuge memory retains the parameters of the last run performed before the **PULSE** key was pressed. At the end of a pulse run, after the centrifuge door is opened and closed the previous run parameters are displayed.

Programmed Operation

The instrument internal memory can store up to 10 programs which can be recalled by keypad numbers 0 through 9. Saved programs are retained in memory even if the power is turned off. Procedures for entering run parameters are the same for programmed operation as those described above for manual operation.

Creating a New Program

1 Press **PROGRAM**, then use the keypad or arrow keys to select a program number that is not in use, or one that you want to overwrite, and press **ENTER/SAVE**.
The program number flashes.

2 Enter run parameters (rotor, speed, time, temperature, acceleration/deceleration rate settings). Press **ENTER/SAVE**.

If you entered an unacceptable parameter, an error message will be displayed.

Press **CE** and enter an acceptable value, then press the next run-parameter key.

3 When all parameters are entered, press **ENTER/SAVE**.

- The program is saved into memory and “**Program saved**” appears on the display.
- The program number displayed will stop flashing.

If any parameters are then modified, the program number will show a dash

4 Press **ENTER/SAVE** and then **START** to run the programmed run.

NOTE If the **PROGRAM** key is pressed while the program number is flashing, program mode is exited without saving entered parameters into program memory.

Recalling a Program

1 Press **PROGRAM**, then use the keypad or arrow keys to enter the number of the program. Press **ENTER/SAVE** to recall a program or press **PROGRAM** to exit program mode. The program parameters are displayed if **ENTER/SAVE** was pressed.

-
- 2** Press **ENTER/SAVE** and **START** to begin the programmed run.

The run starts, the green light next to the **START** key flashes, and the rotor begins to spin.

NOTE To begin a run, **ENTER/SAVE** must always be the last key pressed before pressing **START**. If you wait more than 5 seconds, the **START** key will not activate. If this happens, press **ENTER/SAVE** and **START** again to begin the run.

The run will end automatically when the time display counts down to zero.

Press **STOP** to terminate a run at any time.

- The green light next to the **STOP** key will flash while the rotor decelerates.
- A tone will sound when the rotor has come to a complete stop.

-
- 3** After the rotor has stopped and the LED is lit, press **DOOR**.

The door opens.

-
- 4** Remove the rotor (or containers).
-

Disabling/Enabling the Audible Tones

The audible tones (beeps) that sound when a run-parameter key is pressed, or at the end of each run, or if an error occurs may be turned on and off by following the steps below (rotor must be at 0 RPM).

-
- 1** To disable the key or error tone press **ENTER**, then press **2 3 6**.

The words “**Disable KEY beep**” appear on the display.

-
- 2** To disable the end-of-run tone, press **ENTER**, then press **2 2 3**.

The words “**Disable RUN beep**” appear on the display.

Tones that have been disabled can be enabled as follows.

-
- 1** To enable a key or error tone press **ENTER**, then press **2 3 5**.

The words “**Enable KEY beep**” appear on the display.

-
- 2** To enable the end-of-run tone press **ENTER**, then press **2 2 2**.

The words “**Enable RUN beep**” appear on the display.

Troubleshooting

Introduction

This section lists possible malfunctions, together with probable causes and corrective actions. Maintenance procedures are given in [CHAPTER 4, Care and Maintenance](#). For any problems not covered here, call Beckman Coulter Customer Service at 1-800-742-2345 (U.S.A. or Canada) or contact your local Beckman Coulter Representative for assistance.

NOTE It is your responsibility to decontaminate the instrument, as well as any rotors and/or accessories, before requesting service by Beckman Coulter Field Service.

User Messages

User messages appear on the display to communicate information about the instrument or to alert you to abnormal conditions that need attention.

- Help and informational messages caused by incorrect input or certain operating conditions can be cleared by pressing **CE** and following the instructions in the message.
- Diagnostic messages that result from abnormal operating conditions or equipment malfunction require troubleshooting. Refer to [Table 3.1](#) to determine the nature of the condition and any recommended actions. If a problem persists after you have performed the recommended action, call Beckman Coulter Field Service at 1-800-742-2345 (U.S.A. or Canada) or contact your local Beckman Coulter Representative. To help the field service representative diagnose and correct the problem, gather as much information about the situation as you can, including:
 - the diagnostic number and message,
 - the operating situation when the diagnostic condition occurred (such as rotor in use, speed, or load type), and
 - any unusual environmental and/or operating conditions (such as ambient temperature or voltage fluctuations).

Table 3.1 Diagnostic Message Chart

Diagnostic Number/ Message	Problem	Result	Recommended Action
P1 – Power failure occurred, see manual	System or facility power failure	Run shuts down	Press CE to clear message. Restart run. Remaining time shows on display.
L1 through L6 – Door latch, call Service	Latches are not operating properly	Error message appears; run shuts down with no brake	Press down on both sides of the door until the DOOR LED comes on. If you close the door repeatedly and the problem continues, call Beckman Coulter Field Service.
L7 – Can't open door, see manual	Door latches do not release	Door doesn't open when DOOR key is pressed	Press down on the door, then press DOOR again. If door still doesn't open call Beckman Coulter Field Service. (Procedures for retrieving your sample are at the end of this section.) If the door opens but the message stays on the display, press CE to clear.
C1 – Rotor temp exceeds 4C above set	Rotor temperature exceeds temperature setting by more than 4°C but less than 8°C after equilibration	Run continues; the message is informational	Press CE to clear message.
C2 – Rotor temp exceeds 8C above set, call Service	Rotor temperature exceeds temperature setting by more than 8°C after equilibration	Run shuts down	Call Beckman Coulter Field Service. ^a
C3 and C5 – Temp error, call Service	Refrigeration system error	Run shuts down with maximum brake	Call Beckman Coulter Field Service.
T1 and T2 – Temp, door locks for 45 minutes, call Service	System temperature problem	Run shuts down with no brake; door locks for 45 minutes	Call Beckman Coulter Field Service.
T3 – Temp, door locks for 45 minutes, see manual	Motor overheated	Run shuts down with no brake; door locks for 45 minutes	Wait 45 minutes for motor to cool down, then restart run. If problem persists, call Beckman Coulter Field Service.
D1 through D9 – Drive error, call Service	Drive system problem	Run stops, usually with no brake	Call Beckman Coulter Field Service. Before trying to open the door, listen carefully and make sure that no sound is coming from the chamber (indicating a spinning rotor). Follow the directions under <i>Retrieving Your Sample in Case of Power Failure</i> , below.

Table 3.1 Diagnostic Message Chart (Continued)

Diagnostic Number/ Message	Problem	Result	Recommended Action
R1 and R2 – Rotor ID problem, call Service	No magnets identified, or magnets incorrectly identified	Run continues, speed may be derated	Press CE to clear message. If problem repeats, call Beckman Coulter Field Service.
R3 – Rotor ID mismatch, check rotor	The entered rotor number is not the same as the rotor identified	Run shuts down with maximum brake	Press CE to clear message. Enter the correct rotor entry identification.
R4 and R5 – No rotor match, see manual	The system cannot identify the rotor	Run shuts down with maximum brake	<ul style="list-style-type: none"> • Make sure the rotor in use is a compatible Beckman Coulter rotor (see Available Rotors in CHAPTER 1). Check that magnets are in place on rotor bottom. Press CE to clear the message. • Call Beckman Coulter Field Service.
S1 – System error, call Service	There is a problem with the system control software, EPROM, or RAM	System shuts down, no brake	Call Beckman Coulter Field Service.
S8 – System error, door locks for 45 minutes, see manual	There is a problem with the system control software	Run shuts down with no brake, door locks for 45 minutes	Wait 45 minutes then press CE to clear message, restart run. If problem persists, call Beckman Coulter Field Service.
H1 , H2 , and H4 – Speed error, call Service	Speed control problem	Run shuts down with maximum brake.	Call Beckman Coulter Field Service.
H3 , H5 , and H6 – Speed error, door locks for 45 minutes, call Service	Speed control problem	Run shuts down with no brake; door locks for 45 minutes	Call Beckman Coulter Field Service.

Table 3.1 Diagnostic Message Chart (*Continued*)

Diagnostic Number/ Message	Problem	Result	Recommended Action
I1 – Imbalance, see manual	Rotor load is severely out of balance	Run shuts down with maximum brake	<ul style="list-style-type: none"> • Make sure that tubes or bottles are balanced and loaded symmetrically in the rotor as described in the applicable rotor manual. • With swinging bucket rotors, remove the buckets and clean and lubricate the pivot pin sockets where the buckets contact as described in the applicable rotor manual. Unlubricated pivot pin sockets can prevent the buckets from reaching horizontal position, which can cause imbalance. • Press CE to clear message.
	Rotor tie-down is not properly fastened	Run shuts down with maximum brake	Make sure rotor lid is properly aligned and tie-down T-bar is securely fastened. Press CE to clear message.
	Centrifuge is misaligned (tilted)	Run shuts down with maximum brake	Level the centrifuge on the bench or table. Press CE to clear message.
	Centrifuge was moved during operation	Run shuts down with maximum brake	After the rotor comes to a complete stop, open and close the centrifuge door, then restart. Press CE to clear message.
	Drive error (mechanical damage)	Run shuts down with maximum brake	Call Beckman Coulter Field Service.
I4, I5, and I6 – Imbalance error, call Service	Imbalance sensor failed or improperly calibrated	Cannot start run	Call Beckman Coulter Field Service.

a. Call 1-800-742-2345 (U.S.A. or Canada) or contact your local Beckman Coulter Representative.

Other Possible Problems

Operating problems that may not be indicated by diagnostic messages are described in [Table 3.2](#), along with probable causes, listed in the probable order of occurrence, and corrective actions. Perform the recommended corrective action in sequence, as listed. If you are unable to correct the problem, call Beckman Coulter Field Service at 1-800-742-2345 (U.S.A. or Canada) or contact your local Beckman Coulter Representative.

Table 3.2 Troubleshooting Chart

Problem	Problem/Result	Recommended Action
Rotor cannot achieve set speed	Line voltage below rating	Have a qualified service person measure line voltage while the instrument is operating.
	Electrical failure	Make sure the power cord is securely connected; call Beckman Coulter Field Service.
	Motor failure	Call Beckman Coulter Field Service.
Door will not open	Rotor spinning	Wait until the rotor stops.
	Power not on	Plug in the power cord; turn power on.
	Source power failure	See Retrieving Your Sample in Case of Power Failure , below.
Displays are blank	Power not on	Plug in the power cord; turn power on.
	Electrical failure	Make sure the power cord is securely connected; call Beckman Coulter Field Service.
Chamber does not reach selected temperature	Centrifuge cannot maintain selected temperature for rotor in use at speed selected	<ul style="list-style-type: none"> • Precool or prewarm rotors before running at low or high temperatures. • Precool rotor chamber by running a 30-minute cycle at the required temperature with the speed set at 2000 RPM. • Make sure the air intake vent is clear. • If using multiwell-plates for runs exceeding 2 hours in a warm and/or humid environment, speed reduction may be required to maintain low sample temperature.
Chamber icing	Excess humidity in chamber	Wipe out moisture from the chamber and the chamber gasket before each run.
	Condensation build-up between runs	<ul style="list-style-type: none"> • Leave door open between runs. • Set temperature to a setting higher than ambient temperature. • Turn centrifuge power off.

Retrieving Your Sample in Case of Power Failure

If facility power fails, you will have to restart the run when the power is restored. In the event of an extended power failure, it may be necessary to trip the door-locking mechanism manually to remove the rotor and retrieve your sample.

- 1 Turn the power off and disconnect the power cord from the main power source.
No displays or LEDs are lit.

- 2 Make sure that the rotor is not spinning.
No sound or vibration comes from the centrifuge.



Never attempt to override the door interlock system while the rotor is spinning.

- 3 Locate the two joined release cords underneath the bottom center of the centrifuge (not visible from the centrifuge front). See [Figure 3.1](#).

Figure 3.1 Door Latch Override

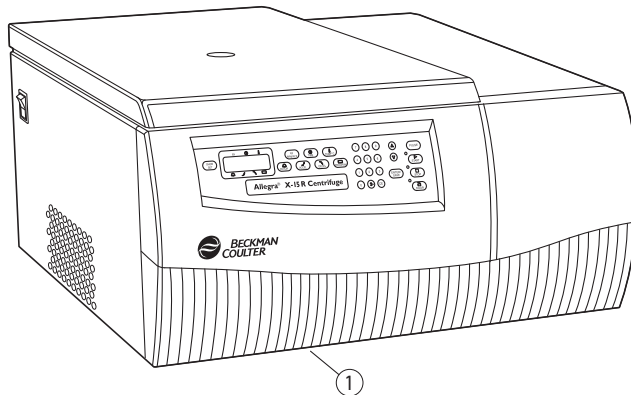

1. Release cord

- 4 Pull on the cords or insert a screwdriver through the two cords and pull to release.
The latch releases and the door opens.
If the rotor is still spinning, *close the door and wait until it stops before attempting to remove it.*



Never attempt to slow or stop the rotor by hand.

Care and Maintenance

Introduction

This section contains care and maintenance procedures that should be performed regularly. For maintenance not covered in this manual, call Beckman Coulter Customer Service at 1-800-742-2345 (U.S.A. or Canada) or contact your local Beckman Coulter Representative for assistance. User messages and recommended actions are discussed in [CHAPTER 3, Troubleshooting](#).

NOTE It is your responsibility to decontaminate the centrifuge, as well as any rotors and/or accessories, before requesting service by Beckman Coulter Field Service.

Instrument Care

 **WARNING**

Any maintenance procedure requiring removal of a panel exposes the operator to the possibility of electrical shock and/or mechanical injury. Therefore, turn the power off and disconnect the instrument from the main power source, and refer such maintenance to service personnel.

Maintenance

Perform the following procedures regularly to ensure continued performance and long service life of the centrifuge.

- 1** Inspect the centrifuge chamber for accumulations of sample, dust, or glass particles from broken sample tubes.
Clean as required (see [Cleaning](#), below).
- 2** Check the air intake and exhaust for obstructions. Keep vents clear and clean.

-
- 3 Wipe condensation out of the rotor chamber between runs with a sponge or clean cloth to prevent chamber icing.
-
- 4 If chamber icing occurs, defrost the system and wipe moisture out of the chamber before use. To defrost the system, set the temperature to 30°C for 20 minutes.
(These are suggested settings which may be adjusted as appropriate for your laboratory conditions.)
-

NOTE Before using any cleaning or decontamination methods except those recommended by the manufacturer, users should check with the manufacturer that the proposed method will not damage the equipment.

Cleaning

Clean the centrifuge frequently. Always clean up spills when they occur to prevent corrosives or contaminants from drying on component surfaces.

-
- 1 To prevent accumulations of sample, dust, and/or glass particles from broken sample tubes, keep the chamber clean and dry by frequent wiping with a cloth or paper towel.
 - a. For thorough cleaning, wash the chamber using a mild detergent such as Solution 555 (339555)
 - b. Dilute the detergent with water (10 parts water to 1 part detergent).
 - c. Rinse thoroughly and dry completely.
-
- 2 Clean the centrifuge exterior surfaces by wiping with a cloth dampened with Solution 555. Dilute the detergent with water (10 parts water to 1 part detergent). Do not use acetone.
-
- 3 Remove the rotor from the centrifuge and clean the drive hub regularly using Solution 555 and a soft brush. Dilute the detergent with water (10 parts water to 1 part detergent). Rinse thoroughly and dry completely.
-

Tube Breakage

-
- 1 If a glass tube breaks, and all the glass is not contained in the bucket or rotor, be sure to thoroughly clean the chamber.

⚠ WARNING

Be careful when examining or cleaning the chamber and chamber gasket, as sharp glass fragments may be embedded in their surfaces.

- 2 Examine the chamber gasket to make sure that no glass particles are retained in it. Carefully remove any glass particles that may remain.
- 3 Carefully wipe away any glass particles that remain in the chamber.

Decontamination



If the centrifuge and/or accessories are contaminated with radioactive or pathogenic solutions, perform all appropriate safety and decontamination procedures. Refer to *Chemical Resistances* (publication IN-175) to be sure the decontamination method will not damage any part of the instrument.

Sterilization and Disinfection

The centrifuge is finished with acrylic baking enamel. Ethanol (70%) may be used on this surface. See *Chemical Resistances* for chemical compatibilities of centrifuge and accessory materials.

⚠ CAUTION

Ethanol is a flammability hazard. Do not use it in or near operating centrifuges.

While Beckman Coulter has tested ethanol (70%) and found that it does not damage the centrifuge, no guarantee of sterility or disinfection is expressed or implied. When sterilization or disinfection is a concern, consult your laboratory safety officer regarding proper methods to use.

Circuit Breaker and Fuses

There are no user-replaceable fuses in the centrifuge.

If the centrifuge circuit breaker trips for any reason, the power switch will move to the off (O) position. Reset the circuit breaker by turning the power switch back to the on (I) position. If it trips again immediately, *do not reset it*. Call Beckman Coulter Field Service at 1-800-742-2345 (U.S.A. or Canada) or contact your local Beckman Coulter Representative.



Repeated attempts to reset the centrifuge circuit breaker can cause substantial damage to electrical and electronic components.

Storage and Transport

Storage

To ensure that the centrifuge does not get damaged, contact Beckman Coulter Field Service for specific instructions and/or assistance in preparing the equipment for transport or long-term storage. Temperature and humidity conditions for storage should meet the environmental requirements described under *Specifications* in [CHAPTER 1](#).

Supply List

Call Beckman Coulter Customer Service at 1-800-742-2345 (U.S.A. or Canada) or contact your local Beckman Coulter office for detailed information on ordering parts and supplies. You may also obtain information at www.beckmancoulter.com. For your convenience, a partial list is given below.

Replacement Rotor Parts

Description	Part Number
Anti-rotation kit	392988

Other

NOTE For MSDS information, go to the Beckman Coulter website at www.beckmancoulter.com.

Description	Part Number
Silicone vacuum grease (1 oz)	335148
Solution 555 (1 qt)	339555
Program library record	233679

Installation

Introduction

Preinstallation requirements have been sent prior to shipment of your centrifuge.



This centrifuge weighs 128 kg (283 lb). Do not attempt to lift or move it without assistance.

Space and Location Requirements



Do not place the centrifuge near areas containing flammable reagents or combustible fluids. Vapors from these materials could enter the centrifuge air system and be ignited by the motor.

The centrifuge ships in a cardboard box on a wooden pallet. For easy access, remove the top of the box, the foam insert on top of the centrifuge, and then the upper part (sides) of the box and set them aside. Then, *with the help of another person*, move the centrifuge from the pallet to its final position.

- 1** Position the centrifuge on a level surface, such as a sturdy table or laboratory bench that is able to support the weight of the centrifuge (128 kg/283 lb) and resist vibration.
Make sure that the centrifuge front feet are fully supported on the table.
- 2** Locate the centrifuge in an area with sufficient ventilation to allow for heat dissipation.
- 3** Check that there are 7.6-cm (3-in.) clearances at the sides and back of the centrifuge to ensure sufficient air circulation.
Dimensions are shown in [Figure A.1](#).
Additional clearance is required on the left side to allow access to the power switch.

- 4 Ambient temperatures during operation should not be lower than 10°C (50°F) or higher than 35°C (95°C).
Relative humidity should not exceed 75% (noncondensing).
The centrifuge must have adequate air ventilation to ensure compliance to local requirements for vapors produced during operation.

Figure A.1 Centrifuge Dimensions

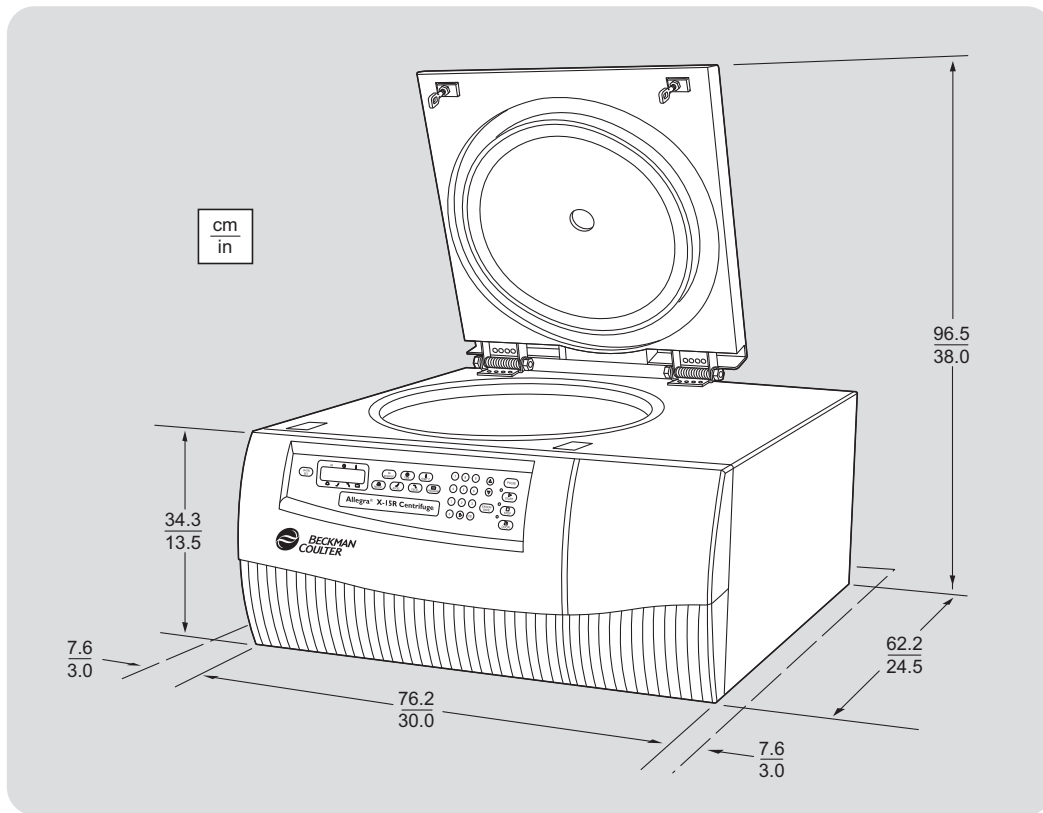

Electrical Requirements

208-V, 60-Hz centrifuge	187–229 VAC, 12 A, 60 Hz
220-V, 60-Hz centrifuge	198–242 VAC, 12 A, 60 Hz
200-V, 50/60-Hz centrifuge	180–220 VAC, 12 A, 50/60 Hz
230-V, 50-Hz centrifuge	207–253 VAC, 12 A, 50 Hz

To reduce the risk of electrical shock, this centrifuge comes with a 2.5-m (8-ft) three-wire electrical cord (attached to the power connector at the rear of the instrument) and plug to connect the centrifuge to earth-ground. The plug for use with 208-VAC, 60-Hz centrifuges is the NEMA 6-15P; a NEMA 6-15R socket should be available. In regions where the instrument is supplied with an

unterminated cord, a plug that meets local electrical and safety requirements must be supplied. (Contact your local Beckman Coulter Service Office for specific information regarding these requirements.)

- 1** Make sure that the matching wall outlet receptacle is properly wired and earth-grounded. Check that the line voltage agrees with the voltage listed on the name rating plate affixed to the centrifuge.
- 2** Never use a three-to-two wire plug adapter.
- 3** Never use a two-wire extension cord or a two-wire non-grounding type of multiple-outlet receptacle strip.
- 4** If there is any question about voltage, have a qualified service person measure it under load while the drive is operating.

To ensure safety, the centrifuge should be wired to a remote emergency switch (preferably outside the room where the centrifuge is housed, or adjacent to the exit from that room) in order to disconnect the centrifuge from the main power source in case of a malfunction.

Securing the Centrifuge to the Bench

Allegra X-15R centrifuges are certified to meet the requirements of the European CE mark. To meet these requirements, the centrifuge must be secured to the bench using the anti-rotation kit shipped with the instrument. This will prevent the centrifuge from moving in the unlikely event of a rotor mishap.

Complete instructions for installing the anti-rotation kit are packaged with the hardware, which is shipped with the centrifuge. The instructions (publication GXR-TB-002) include a full-size template to be used as a guide for drilling holes in the bench. Refer to this document for installation instructions.

The Allegra X-15R may also be secured to the benchtop surface by means of a non-invasive centrifuge restraint system (NICRS), which uses an adhesive to secure the centrifuge to the benchtop. The NICRS installation kit (A79118) contains two adhesive restraining plates, mounting hardware, and easy to follow instructions to secure the Allegra X-15R. Contact your Beckman Coulter representative for purchasing details.

Test Run

NOTE The centrifuge must be plugged in and the power switch turned to on position (I) before the door can be opened.

We recommend that you make a test run to ensure that the centrifuge is in proper operating condition following shipment. See [CHAPTER 2, Operation](#) for instructions on operating the centrifuge.

Beckman Coulter, Inc.

Allegra X-15R Centrifuge Warranty

Subject to the exceptions and upon the conditions specified below and the warranty clause of the Beckman Coulter, Inc. terms and conditions in effect at the time of sale, Beckman Coulter agrees to correct either by repair or, at its election, by replacement, any defects of material or workmanship which develop within one (1) year after delivery of an Allegra X-15R centrifuge (the product), to the original buyer by Beckman Coulter or by an authorized representative, provided that investigation and factory inspection by Beckman Coulter discloses that such defect developed under normal and proper use.

Some components and accessories by their nature are not intended to and will not function for as long as one (1) year. A complete list of such components or accessories is maintained at the factory and at each Beckman Coulter District Sales Office. The lists applicable to the products sold hereunder shall be deemed to be part of this warranty. If any such component or accessory fails to give reasonable service for a reasonable period of time, Beckman Coulter will repair or, at its election, replace such component or accessory. What constitutes either reasonable service and a reasonable period of time shall be determined solely by Beckman Coulter.

Replacement

Any product claimed to be defective must, if requested by Beckman Coulter, be returned to the factory, transportation charges prepaid, and will be returned to Buyer with the transportation charges collect unless the product is found to be defective, in which case Beckman Coulter will pay all transportation charges.

Conditions

Beckman Coulter makes no warranty concerning products or accessories not manufactured by it. In the event of failure of any such product or accessory, Beckman Coulter will give reasonable assistance to the Buyer in obtaining from the respective manufacturer whatever adjustment is reasonable in light of the manufacturer's own warranty.

Beckman Coulter shall be released from all obligations under all warranties, either expressed or implied, if the product(s) covered hereby are repaired or modified by persons other than its own authorized service personnel, unless such repair in the sole opinion of Beckman Coulter is minor, or unless such modification is merely the installation of a new Beckman Coulter plug-in component for such product(s).

Disclaimer

IT IS EXPRESSLY AGREED THAT THE ABOVE WARRANTY SHALL BE IN LIEU OF ALL WARRANTIES OF FITNESS AND OF THE WARRANTY OF MERCHANTABILITY AND THAT BECKMAN COULTER, INC., SHALL HAVE NO LIABILITY FOR SPECIAL OR CONSEQUENTIAL DAMAGES OF ANY KIND WHATSOEVER ARISING OUT OF THE MANUFACTURE, USE, SALE, HANDLING, REPAIR, MAINTENANCE, OR REPLACEMENT OF THE PRODUCT.

Symbol Symbol Simbolo Symbole Simbolo	Simbole СИМВОЛ 符号 記号 상징	Title / Titel / Titolo / Titre / Titolo / Titolo / Название / 标题 / タイトル / 제목
	Dangerous voltage Gefährliche elektrische Spannung Voltaje peligroso Courant haute tension Pericolo: alta tensione	Tensão perigosa Опасное напряжение тока 危険电压 危険な電圧 위험한 전압
	Caution, consult accompanying documents Vorsicht, konsultieren Begleitdokumente Atención, consulta documentos adjuntos Attention, consultez des documents d'accompagnement Attenzione, consulta i documenti di accompagnamento	Cuidado, ulta documentos adjuntos Внимание, советует с сопроводительными документами 注意, 咨询附属单证 注意, 伴う文書に相談しなさい 주의, 동반 문서를 상담하십시오
	Biohazard Potentiell infektiösem Material Riesgo biológico Risque biologique Pericolo biologico	Material infeccioso potencial биологической опасности 可能的传染性物 潜在的な感染性物質 전염하는 물자
	On (power) Ein (Netzverbindung) Encendido Marche (mise sous tension) Acceso (sotto tensione)	Fora (o poder) На (мощности) 开 (电源) ン (電源) 에 (힘)
	Off (power) Aus (Netzverbindung) Apagado Arrêt (mise sous tension) Spento (fuori tensione)	Fora de (poder) С (сила) (电源) ン (電源) 떨어져 (힘)
	Protective earth (ground) Schutzleiteranschluß Puesta a tierra de protección Liaison à la terre Collegamento di protezione a terra	Terra de proteção (terra) Защитное заземление (земля) 保护接地 保護アース (接地) 방어적인 지구 (지상)
	Earth (ground) Erde (Masse) La tierra (suelo) Terre (sol) Scarica a terra	Terra Земли 接地 アース (接地) 지구 (지상)
	Manufacturer Hersteller Fabricante Fabricant Fabbicante	Fabricante производитель 制造商 メーカー 제조자
	Consult Instructions for Use Konsultieren Sie Anwendungsvorschriften Consulte las instrucciones para el uso Consultez les instructions pour l'usage Consulti le istruzioni per uso	Consulte instruções para o uso Советуйте с инструкциями для пользы 咨询使用说明书 使用説明に相談しなさい 사용 설명을 상담하십시오

Related Documents

Chemical Resistances
for Beckman Coulter
Centrifugation Products
(IN-175)

RPM-to-RCF Conversion Chart
for Use when Running
Multiwell-Plate Carriers in the
SX4750A Rotor (GX-TB-015)

Available in hard copy or
electronic pdf by request.

Available at
www.beckmancoulter.com

Anti-Rotation Kit for the
Allegra X-15R Centrifuge
(GXR-TB-002)

Available in hard copy only.

www.beckmancoulter.com

