



# Agilent InfinityLab LC Series 1260 Infinity II Quaternary System

Manual and Quick Guide



**Agilent Technologies**

# Notices

© Agilent Technologies, Inc. 2016

No part of this manual may be reproduced in any form or by any means (including electronic storage and retrieval or translation into a foreign language) without prior agreement and written consent from Agilent Technologies, Inc. as governed by United States and international copyright laws.

## Manual Part Number

G7111-90300

## Edition

04/2016

Printed in Germany

Agilent Technologies  
Hewlett-Packard-Strasse 8  
76337 Waldbronn

## Warranty

**The material contained in this document is provided “as is,” and is subject to being changed, without notice, in future editions. Further, to the maximum extent permitted by applicable law, Agilent disclaims all warranties, either express or implied, with regard to this manual and any information contained herein, including but not limited to the implied warranties of merchantability and fitness for a particular purpose. Agilent shall not be liable for errors or for incidental or consequential damages in connection with the furnishing, use, or performance of this document or of any information contained herein. Should Agilent and the user have a separate written agreement with warranty terms covering the material in this document that conflict with these terms, the warranty terms in the separate agreement shall control.**

## Technology Licenses

The hardware and/or software described in this document are furnished under a license and may be used or copied only in accordance with the terms of such license.

## Restricted Rights Legend

If software is for use in the performance of a U.S. Government prime contract or subcontract, Software is delivered and licensed as “Commercial computer software” as defined in DFAR 252.227-7014 (June 1995), or as a “commercial item” as defined in FAR 2.101(a) or as “Restricted computer software” as defined in FAR 52.227-19 (June 1987) or any equivalent agency regulation or contract clause. Use, duplication or disclosure of Software is subject to Agilent Technologies’ standard commercial license terms, and non-DOD Departments and Agencies of the U.S. Government will

receive no greater than Restricted Rights as defined in FAR 52.227-19(c)(1-2) (June 1987). U.S. Government users will receive no greater than Limited Rights as defined in FAR 52.227-14 (June 1987) or DFAR 252.227-7015 (b)(2) (November 1995), as applicable in any technical data.

## Safety Notices

### CAUTION

A **CAUTION** notice denotes a hazard. It calls attention to an operating procedure, practice, or the like that, if not correctly performed or adhered to, could result in damage to the product or loss of important data. Do not proceed beyond a **CAUTION** notice until the indicated conditions are fully understood and met.

### WARNING

A **WARNING** notice denotes a hazard. It calls attention to an operating procedure, practice, or the like that, if not correctly performed or adhered to, could result in personal injury or death. Do not proceed beyond a **WARNING** notice until the indicated conditions are fully understood and met.

# In This Book

This book describes the Agilent InfinityLab LC Series 1260 Infinity II Quaternary System.

## **1 Introduction**

This chapter gives an introduction to the Agilent 1260 Infinity II LC, the underlying concepts and the features of the Agilent 1260 Infinity II LC.

## **2 Configuration Settings**

This chapter describes how to configure the system.

## **3 Quick Start Guide**

This chapter provides information on running an Agilent 1260 Infinity II LC System.

## **4 Parts and Consumables**

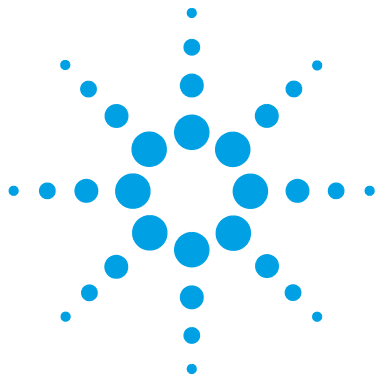
This chapter provides information on additional parts and consumables.

## **5 Appendix**

This chapter provides addition information on safety, legal, and web.

# Contents

<b>1</b>	<b>Introduction</b>	<b>5</b>
	Product Description	6
	Features of the Agilent 1260 Infinity II Quaternary LC	7
	System Components	8
	Solutions	20
	Optimizing the Stack Configuration	24
	Leak and Waste Handling	30
<b>2</b>	<b>Configuration Settings</b>	<b>37</b>
	General Information on LAN Configuration	38
	Instrument Configuration	39
	Lab Advisor	41
<b>3</b>	<b>Quick Start Guide</b>	<b>47</b>
	Best Practices	48
	Prepare a Run	49
	Check Out the System	56
<b>4</b>	<b>Parts and Consumables</b>	<b>69</b>
	Tool Kit	70
	A-Line Quick Connect and Quick Turn Fittings	72
<b>5</b>	<b>Appendix</b>	<b>77</b>
	Safety	78
	Agilent Technologies on Internet	84



# 1 Introduction

Product Description	6
Features of the Agilent 1260 Infinity II Quaternary LC	7
System Components	8
Quaternary Pump G7111B	9
Quaternary Pump VL G7111A	10
Isocratic Pump G7110B	11
Multisampler G7167A	12
Vialsampler G7129A	13
Multicolumn Thermostat G7116A	14
Diode Array Detector HS G7117C	15
Diode Array Detector WR G7115A	16
Variable Wavelength Detector G7114A	17
Fluorescence Detector G7121A	18
Refractive Index Detector G7162A	19
Solutions	20
Walk-up	20
Online SPE	20
1260 Infinity II Multimethod Solution	22
Optimizing the Stack Configuration	24
Agilent A-Line LC Flex Bench	24
One Stack Configuration	26
Two Stack Configuration	28
Leak and Waste Handling	30
Waste Guidance	34
Waste Concept	35

This chapter gives an introduction to the Agilent 1260 Infinity II LC, the underlying concepts and the features of the Agilent 1260 Infinity II LC.



## Product Description

The Agilent 1260 Infinity II LC System is the trusted platform, taking you to the next level of routine analysis, and giving you the instrument choice to achieve best operational efficiency.

A broad range of reliable instrumentation matches with latest column technologies guarantees robust separation and detection performance.

Highest instrument utilization and a fast turnaround cycle is achieved through easy column handling and superior sample logistics from sample submission to data analysis.

The designed for method transferability and stepwise upgrade capability enables a risk-free integration in current infrastructure matching your budget.

## Features of the Agilent 1260 Infinity II Quaternary LC

With an operating pressure of up to 600 bar the 1260 Infinity II Quaternary Pump is compatible with HPLC and UHPLC, i.e. handling 2.1, 3, and 4.6 mm ID columns over the flow rate range (up to 5 mL/min) and semi preparative analysis due to flow up to 10 mL/min.

**Ultralow carryover** – The 1260 Infinity II Multisampler is designed for low carryover, you can take clean to a whole new level with the multi-wash capability, cleaning all relevant injection parts between runs. This sophisticated, integrated feature flushes the injection needle outside with three solvents, and uses seat back flush procedures to reduce carryover to less than 9 ppm.

**Dual-needle injection** – By running samples alternately through one or the other injection path, you can reduce cycle times to mere seconds, virtually eliminating conventional wait times—whether for large volume loadings or flushing procedures.

**Higher sample capacity per benchspace** – Using shallow well-plate drawers, the 1260 Infinity II Multisampler takes a maximum load of 16 microtiter plates and up to 6144 samples—the most of any single system.

**Advanced column capacity for up to 4 columns in a single 1260 Infinity II Multicolumn Thermostat** delivering best flexibility for column switching.

**Fast and easy connections with A-line Quick Connect fittings** to save time and trouble.

**1260 Infinity II DAD HS Detector** delivers lower detection limit and higher data quality for more confidence.

**Seamless integration in your chromatography data system:** Agilent's Instrument Control Framework (ICF) enables smooth control of Agilent LC instrumentation through third-party chromatography data systems.

## System Components

The Agilent 1260 Infinity II LC System consists of the following components:

- Quaternary Pump or Isocratic Pump
- Multisampler or Vialsampler
- Multicolumn Thermostat (MCT)
- Diode Array (DAD), Variable Wavelength (VWD), Refractive Index (RID), or Fluorescence Detector (FLD)
- Evaporative Light Scattering Detector (ELSD) (optional, not stackable)
- Solvent Cabinet

The Agilent 1260 Infinity II LC is described in more detail in the following sections. All modules (except the optional ELSD) are stackable, see [“Optimizing the Stack Configuration”](#) on page 24

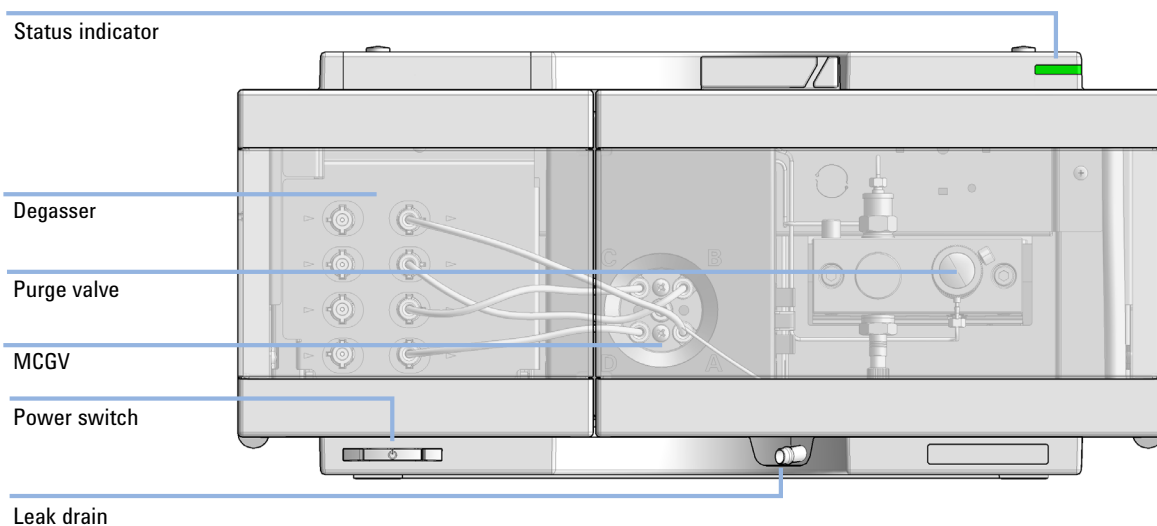
For specifications, please refer to the individual module user documentation.



## Quaternary Pump G7111B

The Agilent 1260 Infinity II Quaternary Pump has an extended power range, delivering pressures up to 600 bar. At these high pressures you can use smaller particle size columns and get higher resolution and faster separations. It maintains virtually pulse-free, well mixed and stable solvent flows. Its dual floating, precise servo-controlled pistons adjust the stroke volume according to your chosen flow rate.

Offering access to up to four solvents, the Agilent 1260 Infinity II Quaternary Pump provides the greatest flexibility in automated solvent blending and is recommended for a wide range of research and routine applications (especially in the food, environmental and pharmaceutical sectors) as well as for method development.

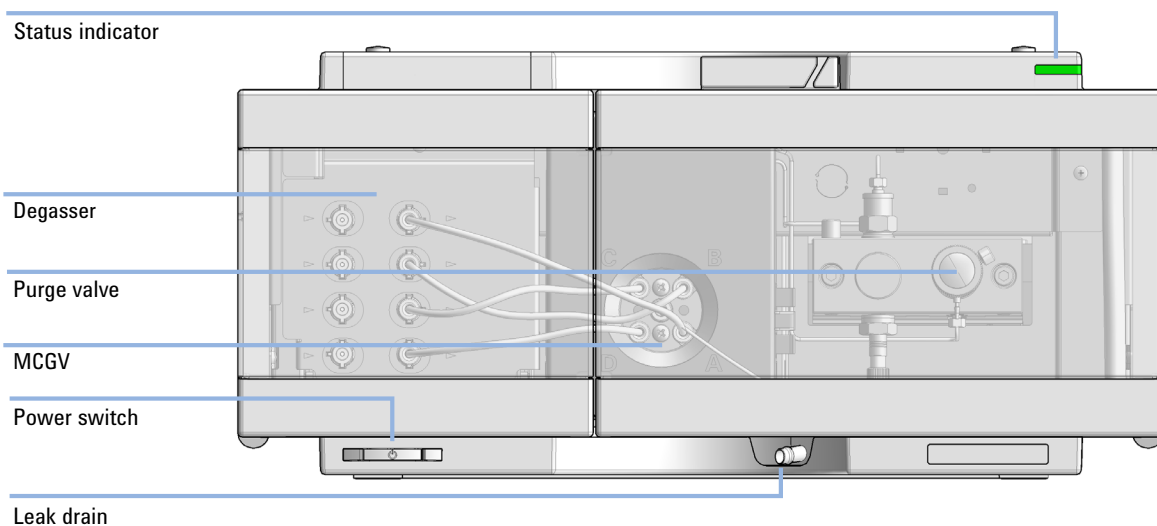


**Figure 1** Overview of the pump

## Quaternary Pump VL G7111A

The Agilent 1260 Infinity II Quaternary Pump VL has an extended power range, delivering pressures up to 400 bar. At these high pressures you can use smaller particle size columns and get higher resolution and faster separations. It maintains virtually pulse-free, well mixed and stable solvent flows. Its dual floating, precise servo-controlled pistons adjust the stroke volume according to your chosen flow rate.

Offering access to up to four solvents, the Agilent 1260 Infinity II Quaternary Pump VL provides the greatest flexibility in automated solvent blending and is recommended for a wide range of research and routine applications (especially in the food, environmental and pharmaceutical sectors) as well as for method development.



**Figure 2** Overview of the pump

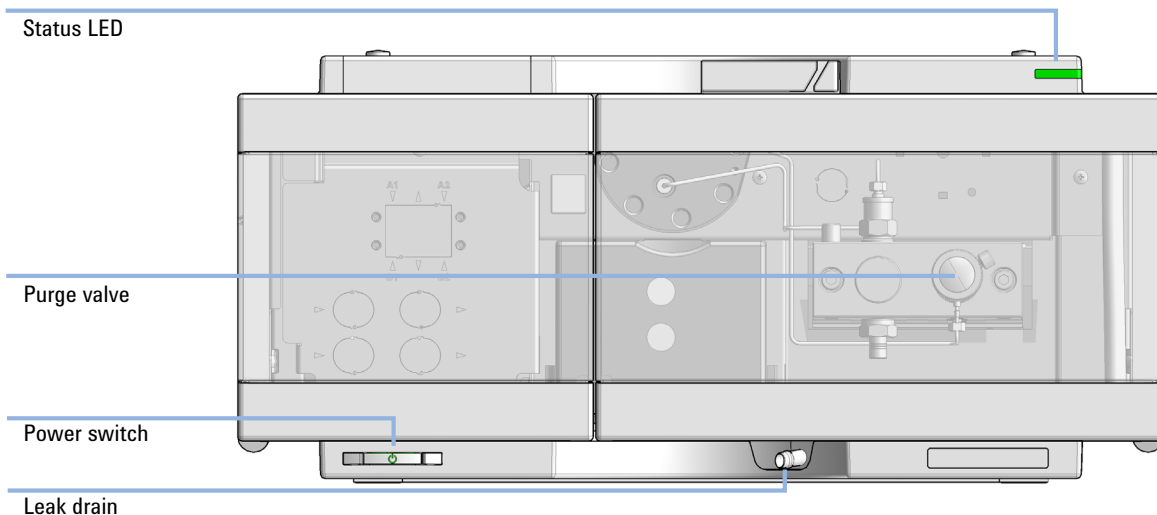
## Isocratic Pump G7110B

The Agilent 1260 Infinity II Isocratic Pump is ideal for demanding QA/QC tasks and routine applications. It maintains virtually pulse-free and stable solvent flows. The dual floating, precise servo-controlled pistons in the delivery mechanism adjust the stroke volume according to your chosen flow rate.

The optional integrated degasser and solvent selection valve offers increased ease-of-use and method flexibility.

The pump can deliver a broad range of pressures up to a maximum 600 bar, giving you the flexibility to use small particle size columns, longer columns or alternative higher viscosity solvents.

The Agilent 1260 Infinity II Isocratic Pump is the ideal pump for GPC/SEC applications where run-to-run and day-to-day precision in retention times is crucial.



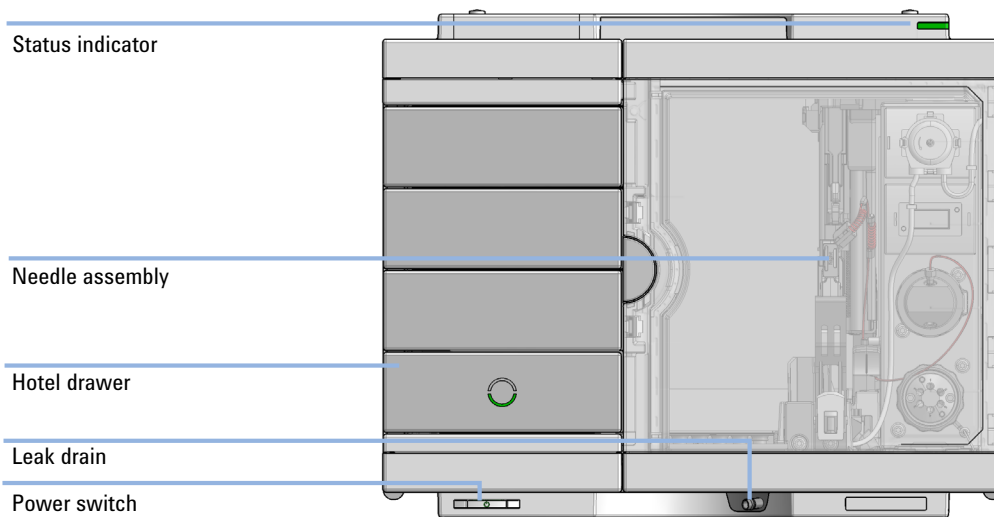
**Figure 3** Overview of the pump

## Multisampler G7167A

The Agilent 1260 Infinity II Multisampler can handle both vials and microtiter plates with ease and efficiency up to 600 bar system pressure, optimized on high flexibility.

This compact module can house up to 6144 samples, all inside the Agilent stack footprint and the robotics to inject each into the chromatograph in turn.

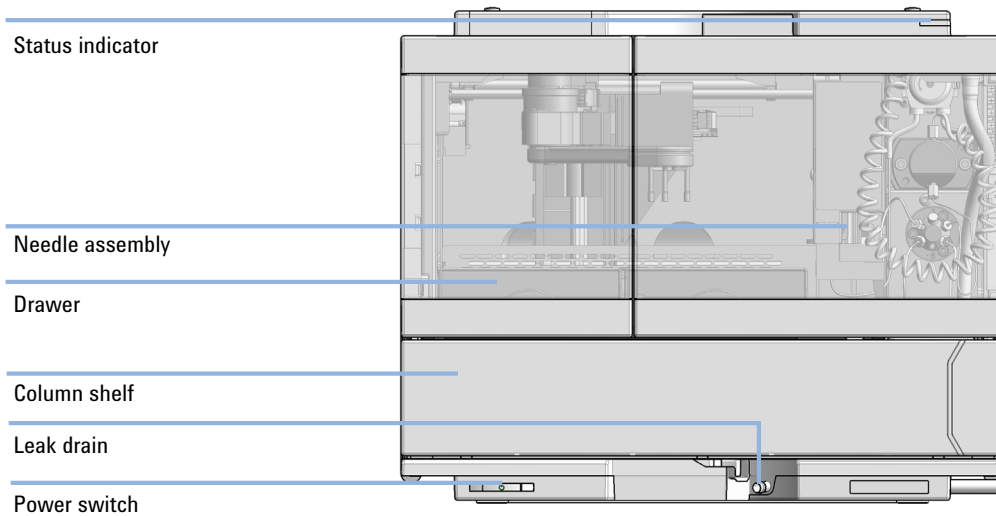
With the multi-wash capability, you can reduce carryover to less than 9 parts per million.



**Figure 4** Overview of the Multisampler

## Vialsampler G7129A

The Agilent 1260 Infinity II Vialsampler is designed for the reliability, safety, and ease-of-use needed for routine pharmaceutical tasks and quality control, as well as for environmental and food analyses. It can house optionally the integrated column compartment for two LC columns with temperature control up to 80 °C as well as a sample cooler for stable temperatures down to 4 °C, all within one module.



**Figure 5** Overview of the Vialsampler

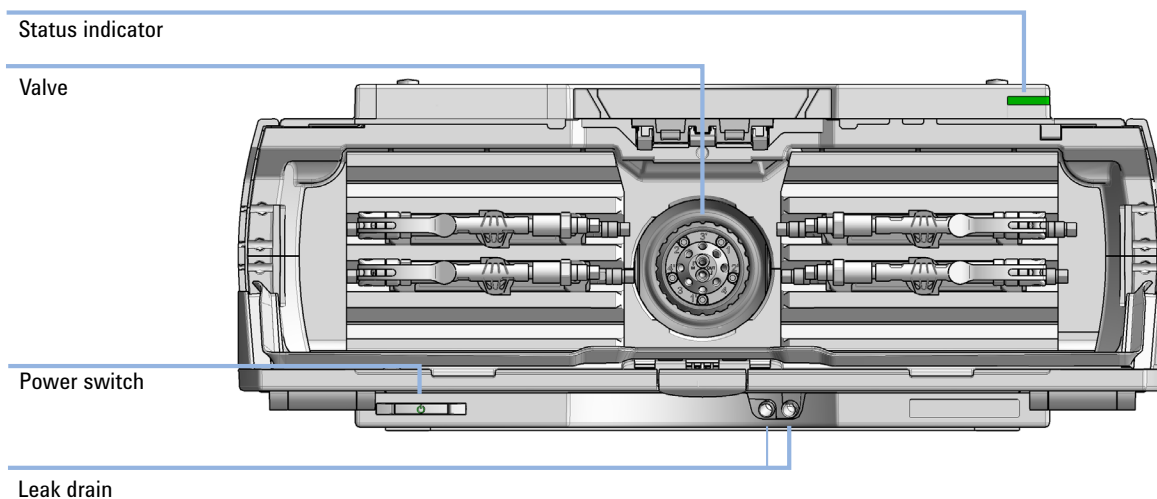
## Multicolumn Thermostat G7116A

The Agilent 1260 Infinity II Multicolumn Thermostat (MCT) allows precise column thermostating over a broad temperature range: from cooling down to 10 degrees below ambient temperature up to 85 °C, providing high flexibility for optimized speed and selectivity of LC separation.

Ultrahigh pressure valves enable a wide range of applications such as column selection from 4 columns in a single MCT, sample preparation for analyte enrichment or matrix removal, alternating column regeneration, etc.

For bio-inert applications bio-inert heat exchangers and a selection of bio-inert valves are offered.

The MCT fits with all 1260 Infinity II modules and can also be combined with modules of the Agilent 1260 and 1290 Infinity II Series.



**Figure 6** Overview of the Multicolumn Thermostat

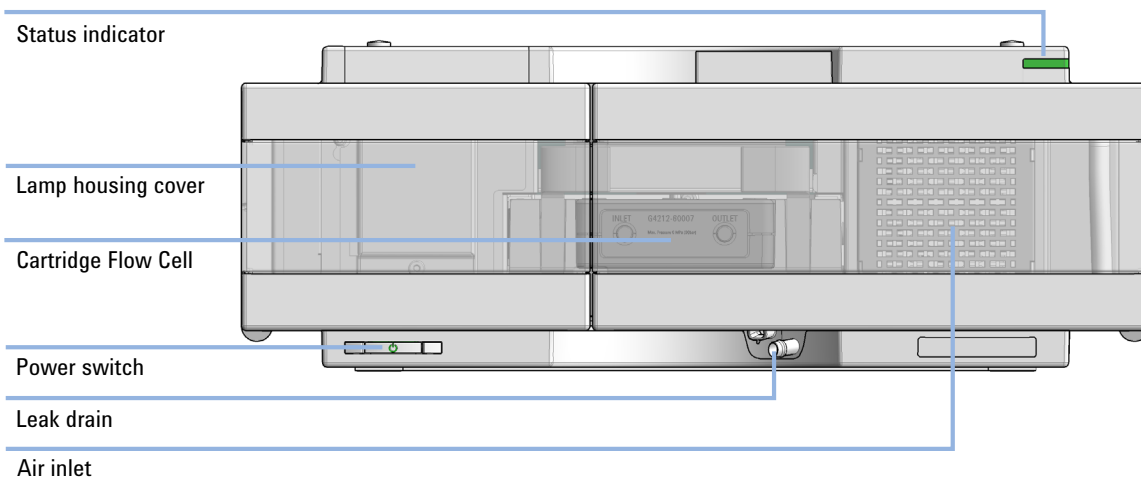
## Diode Array Detector HS G7117C

The Agilent 1260 Infinity II Diode Array Detector HS is based on the Agilent Max-Light cartridge cell with optofluidic waveguides that improve light transmission to near 100 % efficiency without sacrificing resolution caused by cell dispersions effects.

With typical detector noise levels of  $< \pm 0.6 \mu\text{AU}/\text{cm}$  the 60 mm flow cell gives up to 10times higher sensitivity than detectors with conventional flow cells.

Any compromising refractive index and thermal effects are almost completely eliminated, resulting in significantly less baseline drift for more reliable and precise peak integration.

For fast separations, this detector has multiple wavelength and full spectral detection at sampling rates up to 120 Hz.

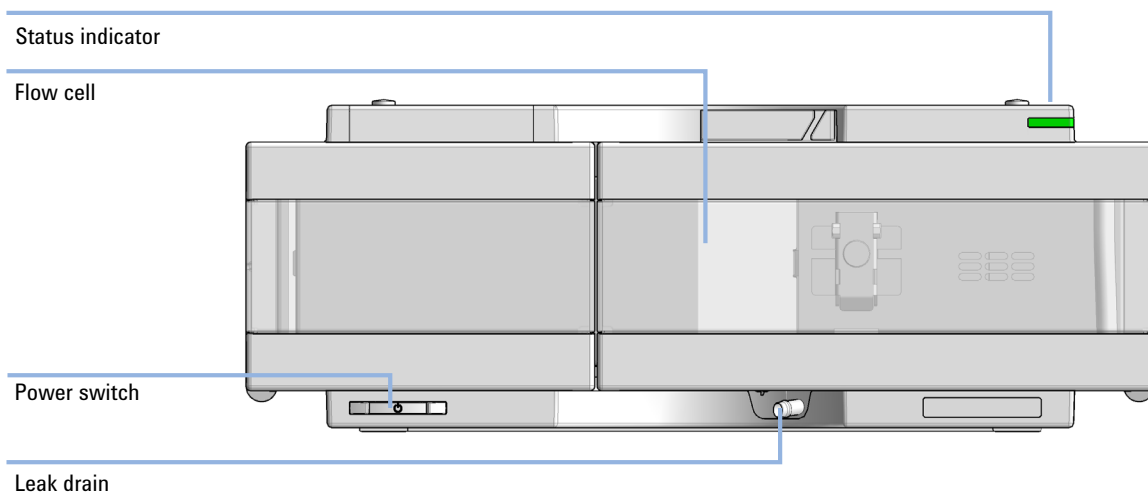


**Figure 7** Overview of the detector

## Diode Array Detector WR G7115A

The 1260 Infinity II DAD WR detector is designed for highest optical performance, GLP compliance, and easy maintenance. With its 120 Hz data acquisition rate the detector is perfectly suited for fast LC applications. The long -life deuterium lamps allow highest intensity and lowest detection limits over a wavelength range of 190 – 950 nm. The use of RFID tags for all flow cells and UV-lamps provides traceable information about these assemblies.

The built-in holmium oxide filter features the fast wavelength accuracy verification, while the built-in temperature controls improves the baseline stability. Additional diagnostic signals for temperature and lamp voltage monitoring are available.



**Figure 8** Overview of the detector



## Variable Wavelength Detector G7114A

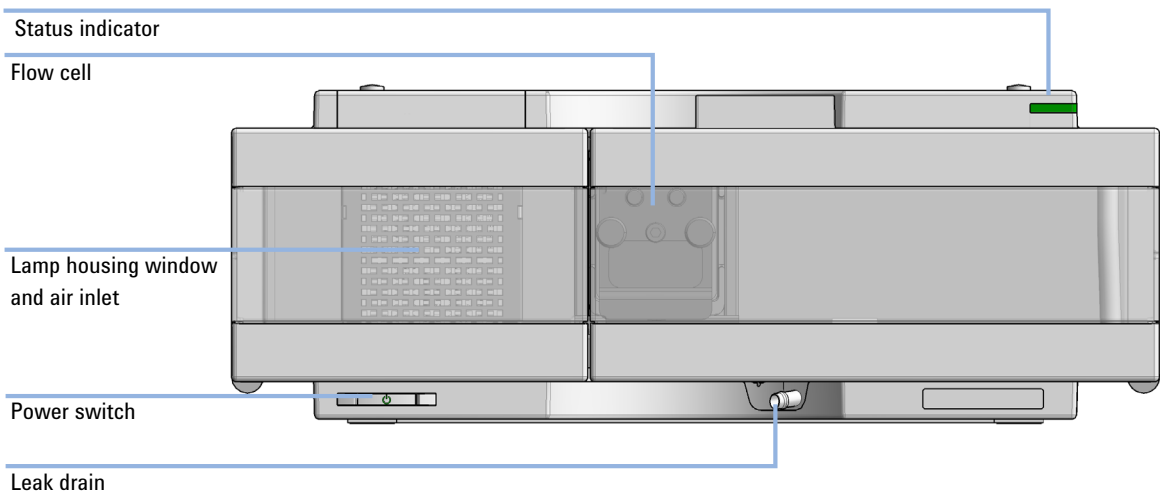
The Agilent 1260 Infinity II Variable Wavelength Detector (VWD) is the most sensitive and fastest detector in its class.

Time-programmable wavelength switching provides sensitivity and selectivity for your applications.

More sample information can be acquired in the dual wavelength mode.

Low detector noise ( $< \pm 2.5 \mu\text{AU}$ ) and baseline drift ( $< 1 \cdot 10^{-4} \text{ AU/h}$ ) facilitates precise quantification of trace level components.

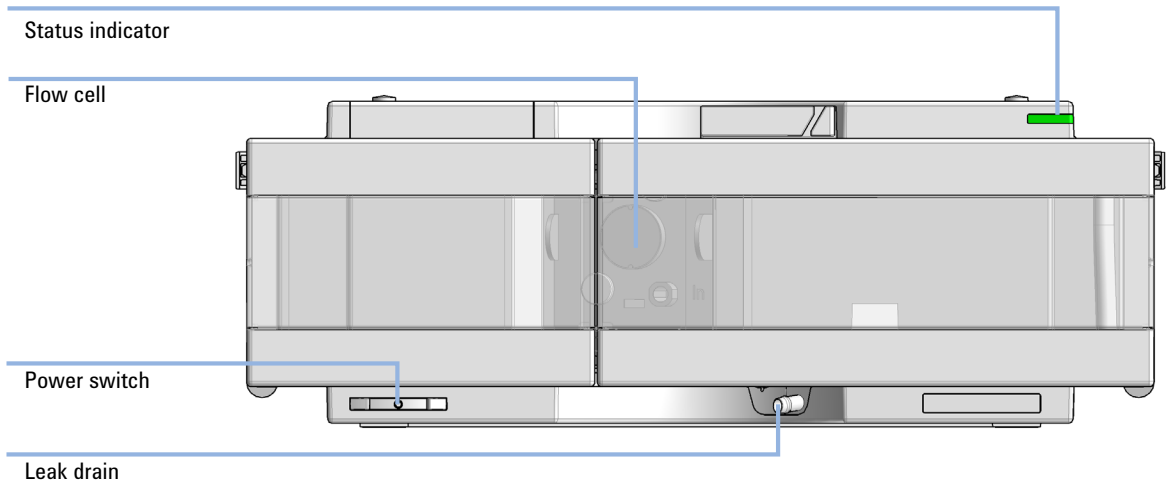
High productivity can be achieved with fast analysis at up to 120 Hz data rates.



**Figure 9** Overview of the detector

## Fluorescence Detector G7121A

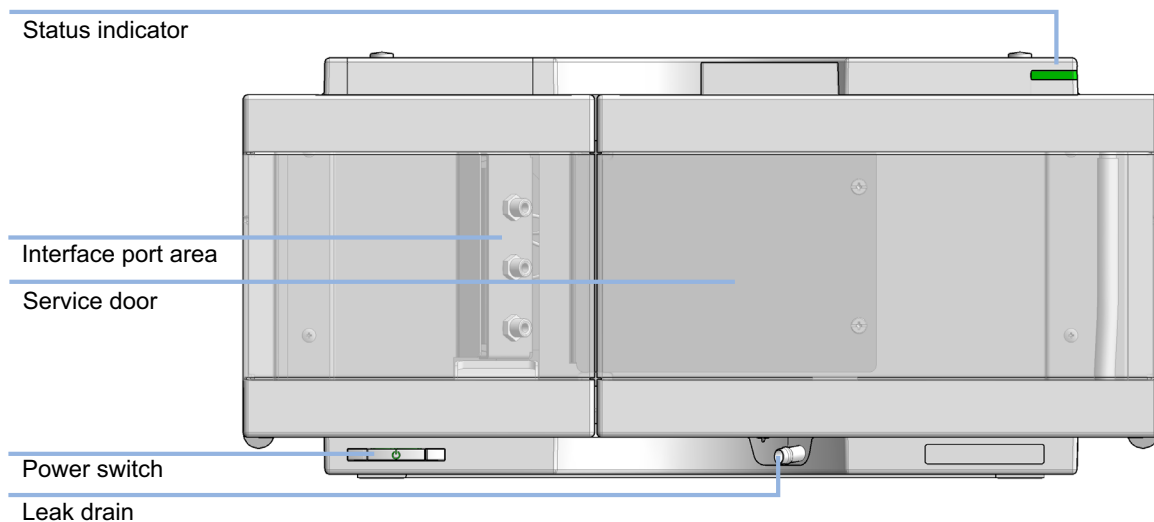
The proven optical and electronic design of the Agilent 1260 Infinity II Fluorescence Detector provides highest sensitivity for the analysis of trace-level components. Time-programmable excitation and emission wavelength switching allows you to optimize the detection sensitivity and selectivity for your specific applications. High-speed detection with up to 74 Hz data rates keeping you pace with the analysis speed of fast LC.



**Figure 10** Overview of the detector

## Refractive Index Detector G7162A

The Agilent 1260 Infinity II Refractive Index Detector (RID) is the ideal detector for fast and reliable LC results when routinely analyzing non-UV absorbing substances, such as carbohydrates, lipids, and polymers. The 1260 Infinity II RID is also the detector of choice for gel permeation chromatography (GPC) or size exclusion chromatography (SEC).



**Figure 11** Overview of the detector

## Solutions

### Walk-up

Agilent's Walkup Software enables simplified access to the power and precision of high quality LC and LC/MS processes for multiple users.

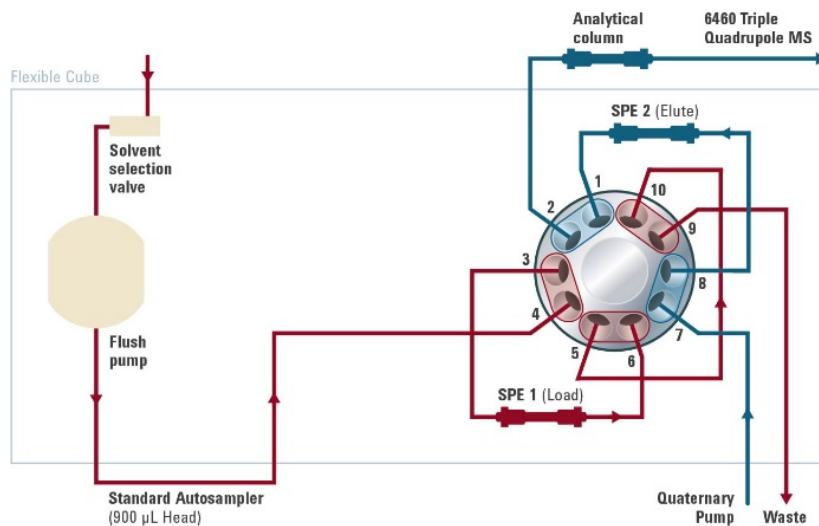
- Users may simply *walk up* to an LC/MS system, input basic sample information and choose from a list of analytical methods or purification schemes available.
- Sample submitters are prompted where to place their samples. They will receive their results by e-mail when the samples are completed.
- Managers of multiple instrument installations can take advantage of networking instruments through an OpenLAB Shared Services Server to allow administration from anywhere in the lab.

### Online SPE

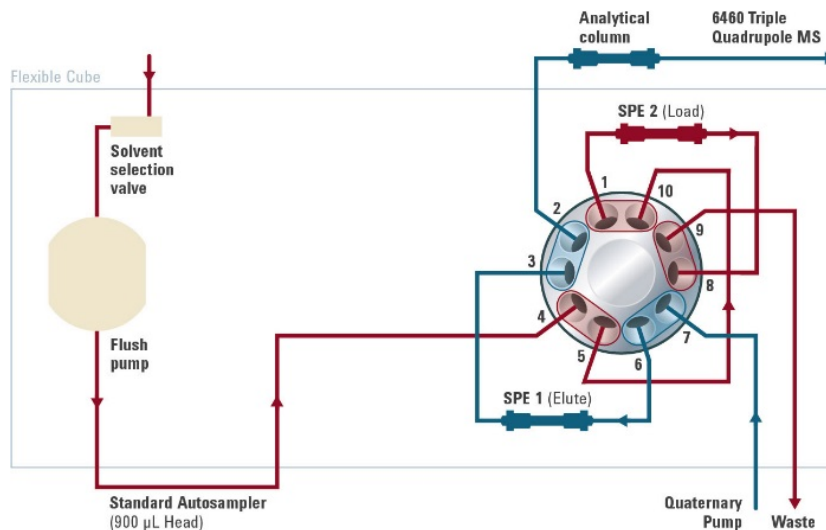
Whether you need to enrich your analytes, remove matrix components, or lower detection limits for e.g. trace-level water analysis, the highly modular design of the Agilent 1290 Infinity II Series Online SPE Solution provides you with the flexibility to tailor your system to match virtually any analytical LC challenge. Agilent's Online SPE Solutions are based on the 1290 Infinity Flexible Cube that houses re-usable SPE cartridges and up to two valves. Combined with the Agilent 6400 Series Triple Quadrupole mass spectrometers the 1200 Infinity Series Online SPE Solution allows ultra-low, trace level detection.

The Online SPE Starter Kit builds the basis for all possible Online-SPE solutions. In an alternating way you can clean, condition and load your sample on one of the cartridges while the second cartridge is in the analytical flow path for analyzing the sample.

In addition to the Online SPE Starter Set the online SPE direct injection kit allows also to bypass the SPE cartridges and inject directly onto the analytical column. With this approach you can use your system either for online SPE analysis or for a direct injection without re-plumbing the system.



**Figure 12** Position 1

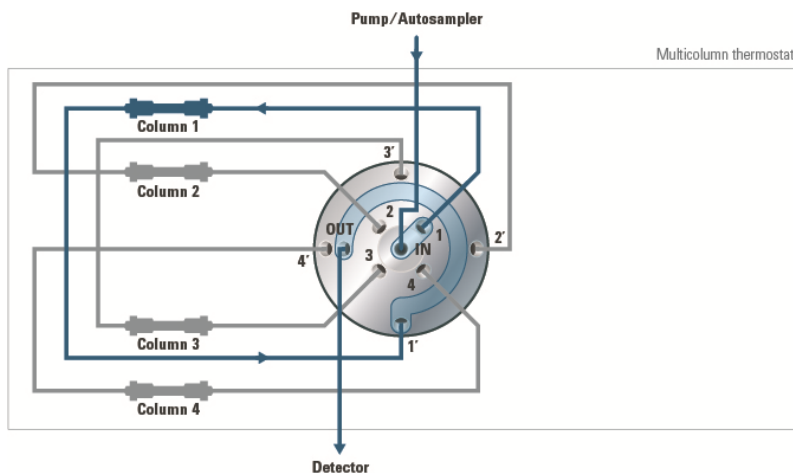


**Figure 13** Position 2

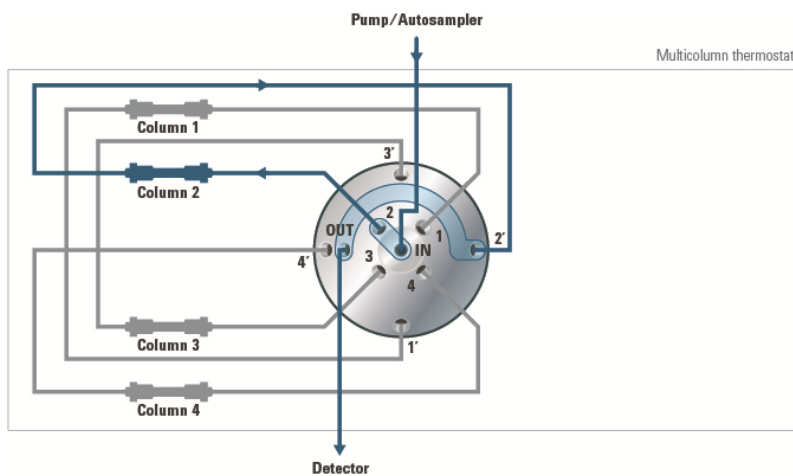
## 1260 Infinity II Multimethod Solution

This configuration allows to increase your labs' efficiency by combining hardware for column-selection with solvent selection. Multiple LC applications using different mobile phases, different gradients, but also different stationary phases can be performed on just one LC instrument. Typically, several users share one instrument, nevertheless use their individual LC methods dedicated to their specific samples. This configuration is chosen to optimize instrument use.

- By using a high-pressure 4-column selector valve (G4237A, 600 bar) inside the 1260 Infinity II Multicolumn Thermostat, up to 4 columns (30 cm length with A-Line fittings or shorter) can be accessed without any re-plumbing. Individual InfinityLab Quick-Connect heat exchangers support pre-column solvent heating for each column. A bio-inert version of the 4-column selector valve is also available. Fingertight A-Line fittings allow a fast exchange of columns when needed.
- A solvent selection valve attached to the LC stack allows additional access of up to 12 different solvents.
- Utilization and productivity of the LC are optimized by switching between several applications run on a single instrument.



**Figure 14** Hydraulic flow path schematics for a 4-column selection setup



**Figure 15** Hydraulic flow path schematics for a 4-column selection setup

## Optimizing the Stack Configuration

To ensure safe operation and optimum performance of an Agilent InfinityLab LC System, Agilent Technologies prescribe stack configurations. The following configurations are possible:

- A-Line Flex Bench
- Single Stack (maximal 4 modules, in a bench rack or directly on the bench)
- Two Stacks (in a bench rack or directly on the bench)

The table below summarizes the advantages of the different prescribed configurations.

**Table 1** Overview on pros and cons of different stack configurations

modules in a stack	Rack Configuration	Single Stack Configuration	Two Stacks Configuration
fewer than 5	<p><b>Pros</b></p> <ul style="list-style-type: none"> <li>• no bench required</li> <li>• mobile</li> <li>• optimal access to the modules, solvent bottles, pumps, columns, and accessories</li> <li>• integrated waste concept</li> </ul>	<p><b>Pros</b></p> <ul style="list-style-type: none"> <li>• minimal bench space required</li> </ul> <p><b>Cons</b></p> <ul style="list-style-type: none"> <li>• high stack</li> </ul>	<p><b>Pros</b></p> <ul style="list-style-type: none"> <li>• lower stacks</li> <li>• flexible combinations</li> </ul> <p><b>Cons</b></p> <ul style="list-style-type: none"> <li>• maximum bench space required</li> </ul>
5 and more	+ possible	- not possible	+ possible

### Agilent A-Line LC Flex Bench

Agilent recommends to use the A-Line LC Flex Bench for all Agilent-LC-Systems.

Main features:

- Increases flexibility in the lab
- Safe moving of LC
- Easy stack customization
- Included waste management



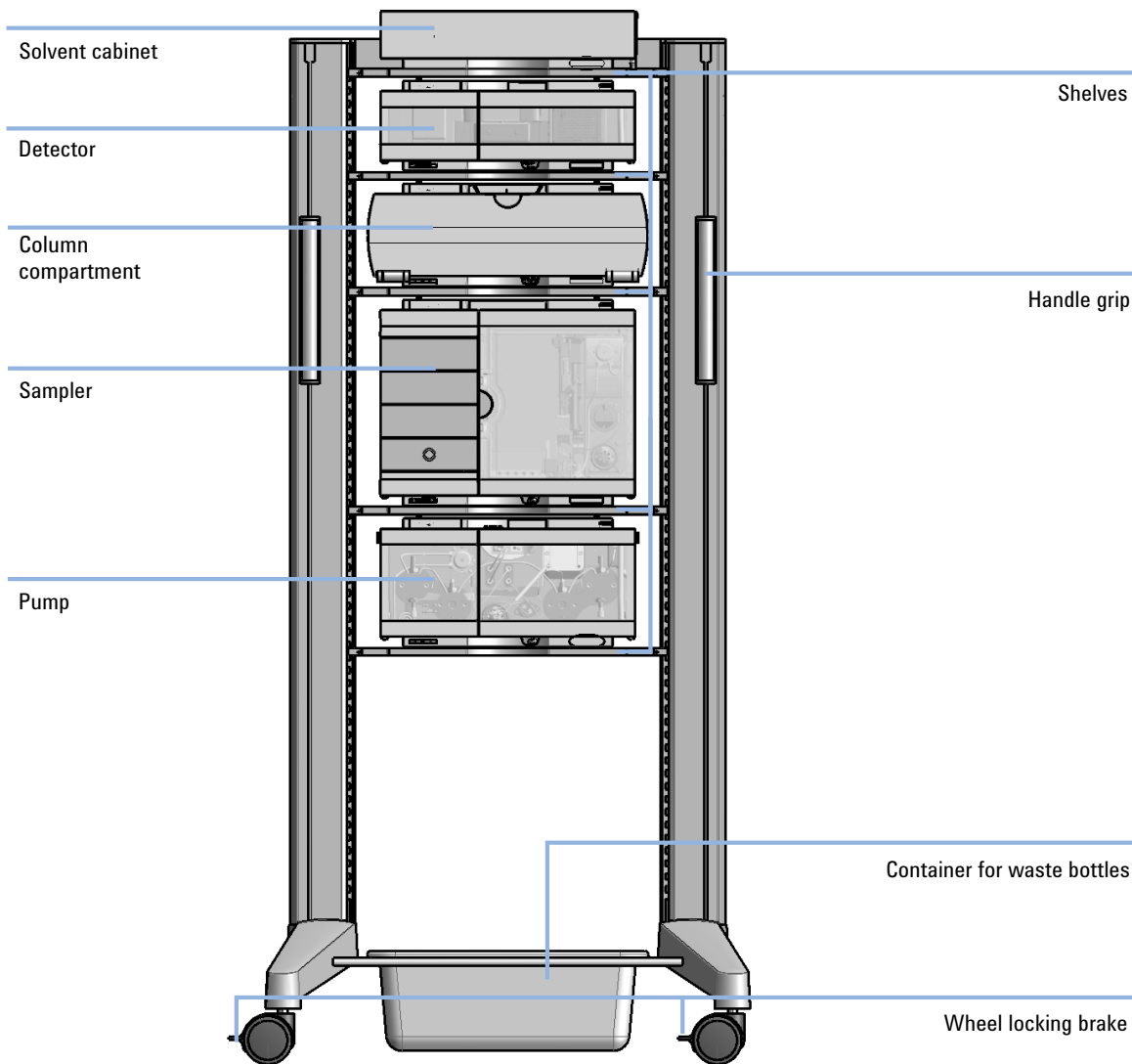
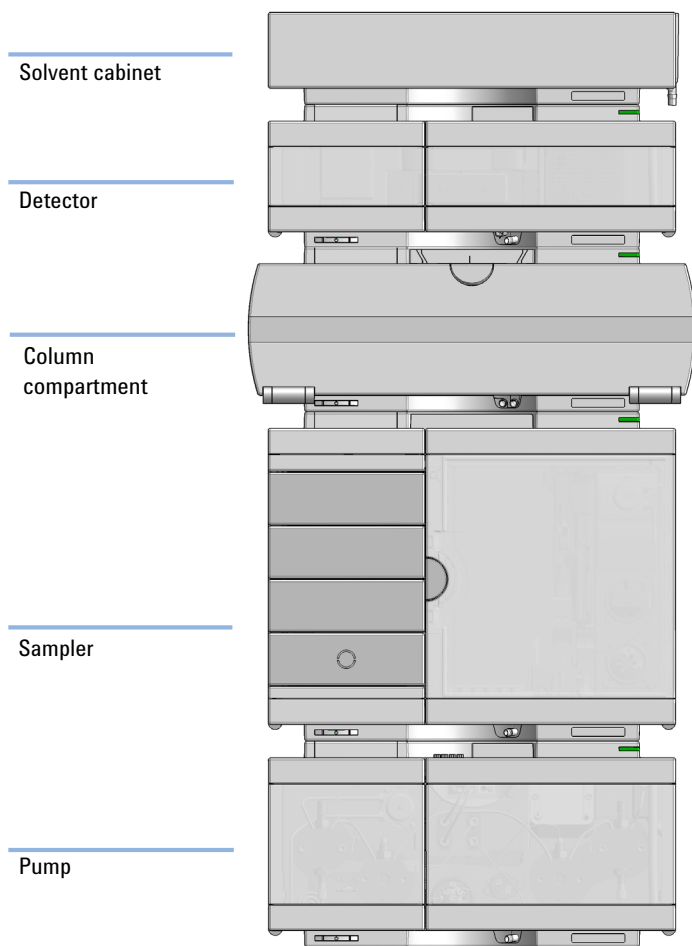


Figure 16 Agilent A-Line LC Flex Bench

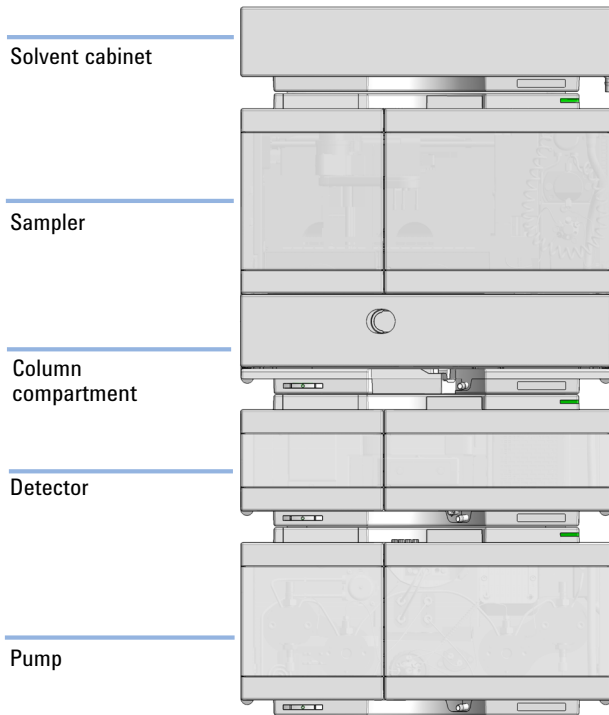
## One Stack Configuration

Ensure optimum performance by stacking the modules as shown exemplarily in [Figure 17](#) on page 26. This configuration optimizes the flow path for minimum delay volume and minimizes the bench space required.



**Figure 17** Single stack configuration (bench installation, example shows a multisampler)

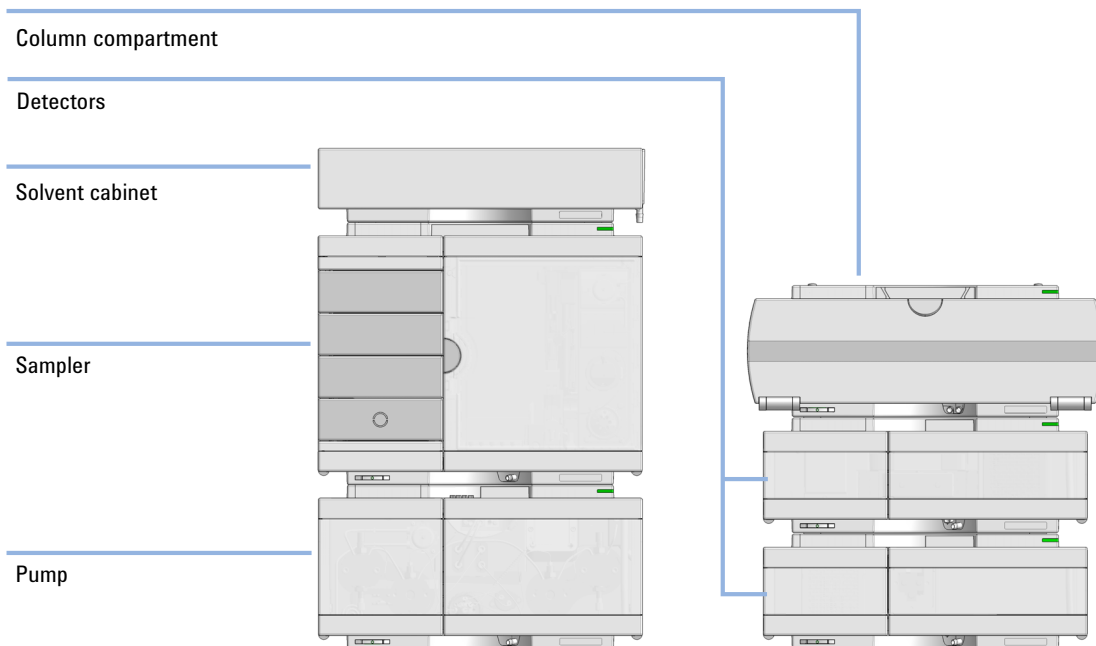
### Vialsampler stack configurations with integrated column compartment



**Figure 18** Single stack configuration (bench installation, example shows a vialsampler with optional ICC installed)

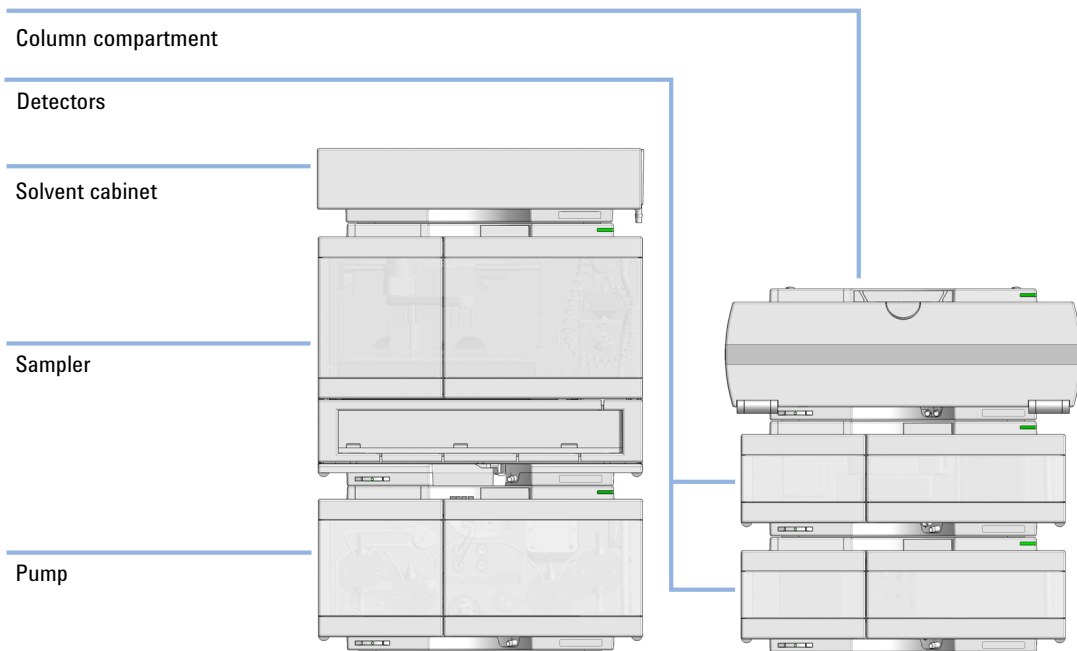
## Two Stack Configuration

To avoid excessive height of the stack (for example when using the system in combination with an additional detector) it is recommended to form two stacks.



**Figure 19** Two stack configuration (bench installation, example shows a multisampler)

## Vialsampler Two Stack Configurations



**Figure 20** Two stack configuration (bench installation, example shows a vialsampler)

## Leak and Waste Handling

The Agilent InfinityLab LC Series has been designed for safe leak and waste handling. It is important that all security concepts are understood and instructions are carefully followed.

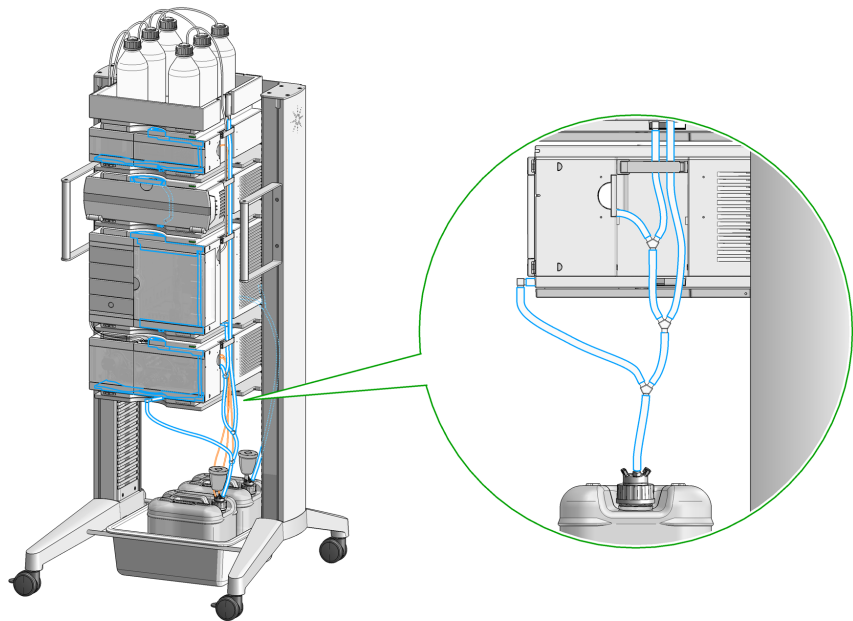
The solvent cabinet is designed to store a maximum volume of 8 L solvent. The maximum volume for an individual bottle stored in the solvent cabinet should not exceed 2 L. For details, see the usage guideline for the Agilent 1200 Infinity Series Solvent Cabinets (a printed copy of the guideline has been shipped with the solvent cabinet, electronic copies are available on the Internet).

All leak plane outlets are situated in a consistent position so that all Infinity and Infinity II modules can be stacked on top of each other. Waste tubes are guided through a channel on the right hand side of the instrument, keeping the front access clear from tubes.

The leak plane provides leak management by catching all internal liquid leaks, guiding them to the leak sensor for leak detection, and passing them on to the next module below, if the leak sensor fails. The leak sensor in the leak plane stops the running system as soon as the leak detection level is reached.

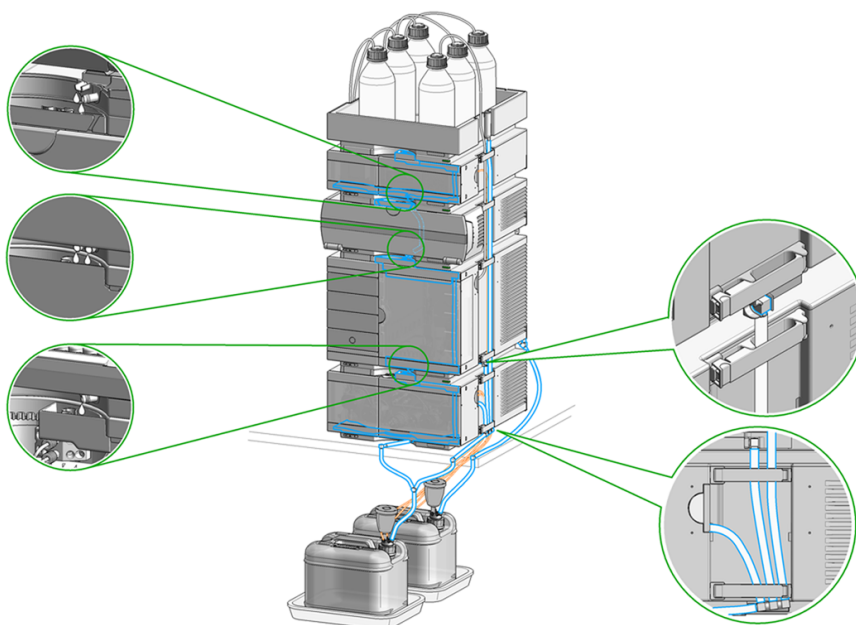
Solvent and condensate is guided through the waste channel into the waste container:

- from the detector's flow cell outlet
- from the Multisampler needle wash port
- from the Sample Cooler (condensate)
- from the Seal Wash Sensor
- from the pump's Purge Valve or Multipurpose Valve



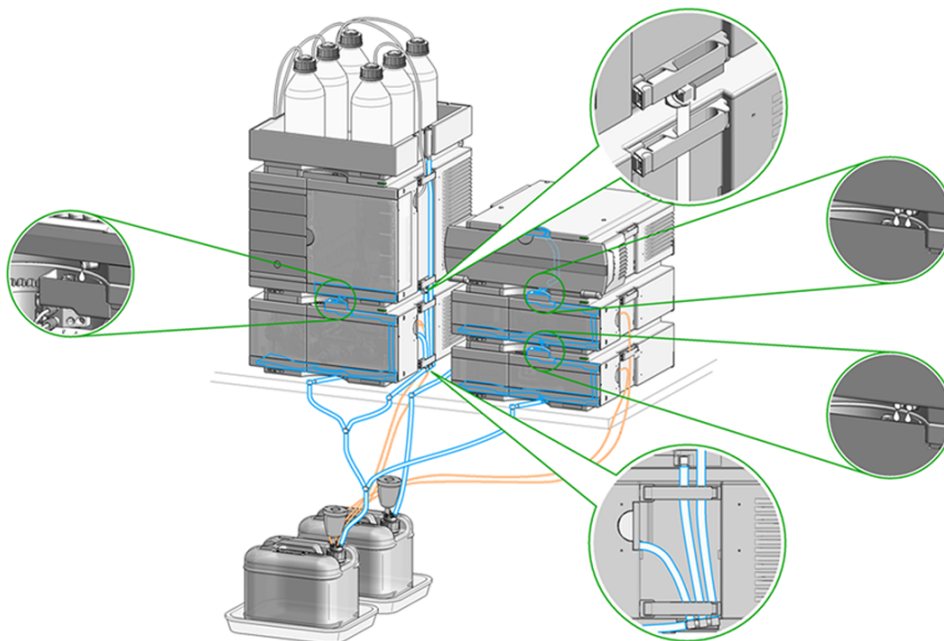
**Figure 21** Infinity II Leak Waste Concept (flexible rack installation)

**1 Introduction**  
Leak and Waste Handling



**Figure 22** Infinity II Single Stack Leak Waste Concept (bench installation)

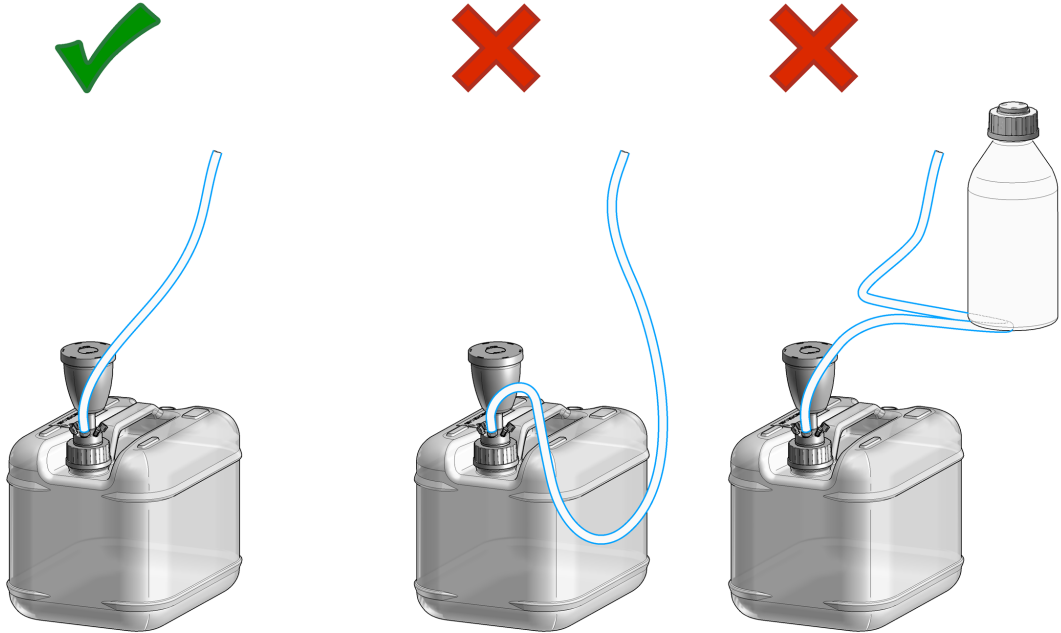




**Figure 23** Infinity II Two Stack Leak Waste Concept (bench installation)

The waste tube connected to the leak pan outlet on each of the bottom instruments guides the solvent to a suitable waste container.

## Waste Guidance



**NOTE**

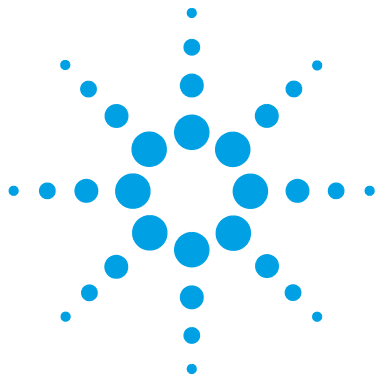
The waste drainage must go straight into the waste containers. The waste flow must not be restricted at bends or joints.

## Waste Concept

- 1 Agilent recommends using the 6 L waste can with 1 Stay Safe cap GL45 with 4 ports (5043-1221) for optimal and safe waste disposal. If you decide to use your own waste solution, make sure that the tubes don't immerse in the liquid.



**1 Introduction**  
Leak and Waste Handling



## 2 Configuration Settings

General Information on LAN Configuration	38
Instrument Configuration	39
Lab Advisor	41
Installing Add-ons	45

This chapter describes how to configure the system.



## 2 Configuration Settings

### General Information on LAN Configuration

## General Information on LAN Configuration

LAN configuration is executed from the module with direct LAN connection to the controller software. This must be the module (usually the detector) with the highest data rate.

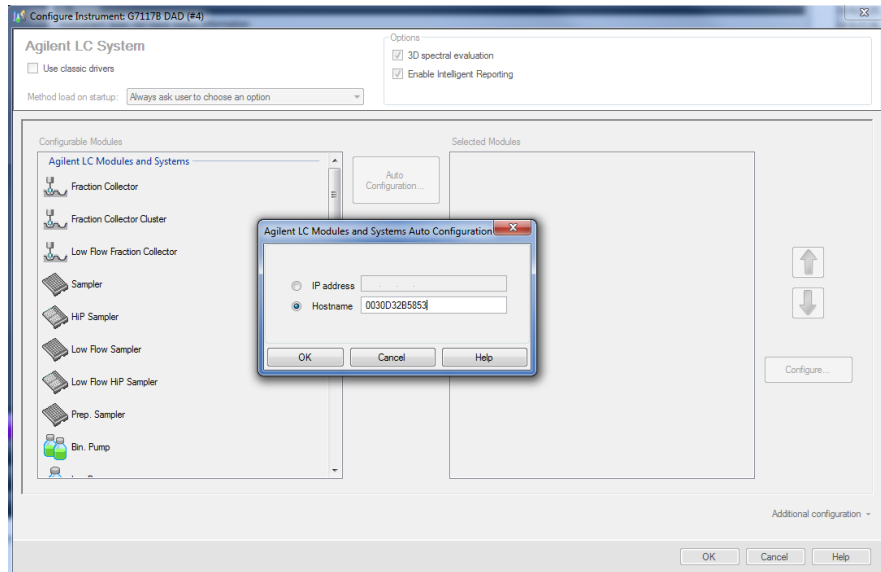
# Instrument Configuration

Example shows an instrument configuration with a Diode Array Detector.

- 1 Set the switches of the Configuration switch at the rear of the module:
  - a All switches DOWN: module uses the default IP address 192.168.254.11.
  - b Switch 4 UP and others DOWN: module uses DHCP.



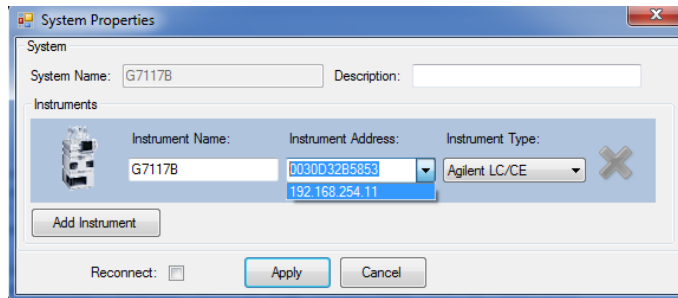
- 2 Enter the setup information (MAC / IP address and/or Instrument Name).
  - a Agilent OpenLab ChemStation (Configure Instrument):



## 2 Configuration Settings

### Instrument Configuration

#### b Lab Advisor (Instrument Overview - Add Instrument):



The screenshot shows a Windows-style dialog box titled "System Properties". It has a "System" section with "System Name" (G7117B) and "Description" (empty). Below is an "Instruments" section with a table of instrument details:

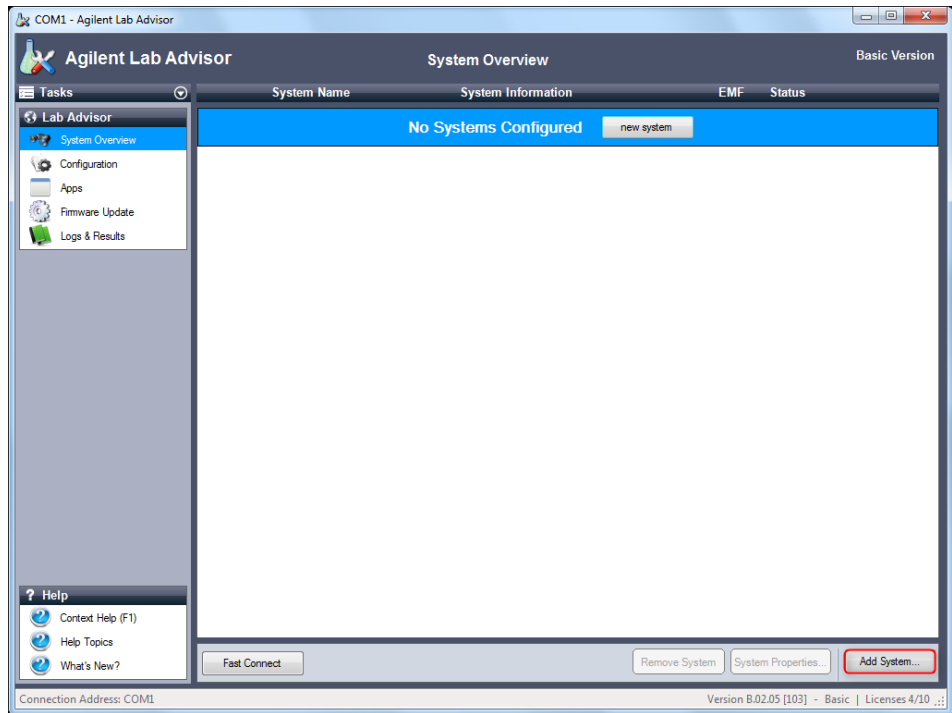
Instrument Name	Instrument Address	Instrument Type
G7117B	192.168.254.11	Agilent LC/CE

Buttons at the bottom include "Add Instrument", "Reconnect" (checkbox), "Apply", and "Cancel".



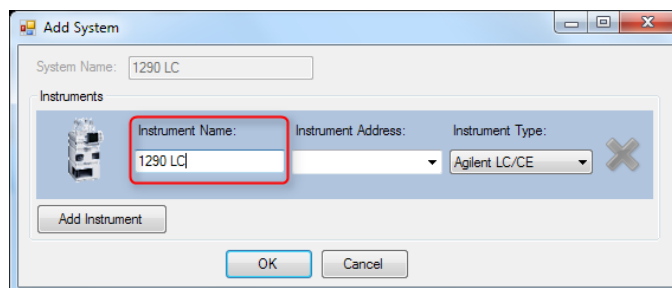
# Lab Advisor

1 In the Action Panel of the **System Overview**, click **Add System**.



## 2 Configuration Settings Lab Advisor

The **Add System** dialog box is displayed.

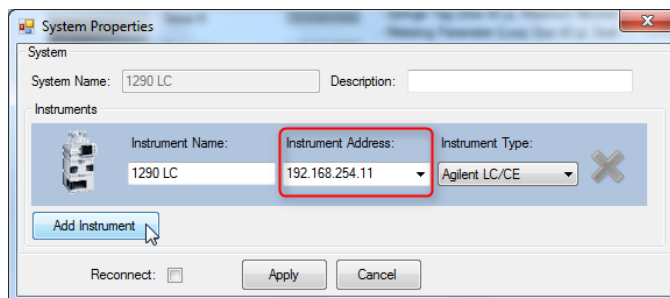


2 Enter a name in the **Instrument Name** field.

### NOTE

If your system comprises just one instrument, the **Instrument Name** is copied to the **System Name** field.

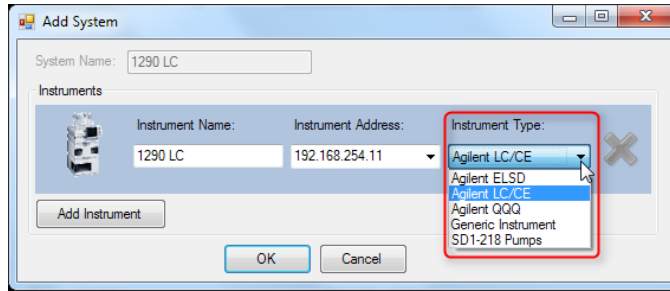
3 Enter the connection details in the **Instrument Address** field.



### NOTE

The **Instrument Address** can be an IP address, the host name or, if you are connecting using a serial cable, the COM port.

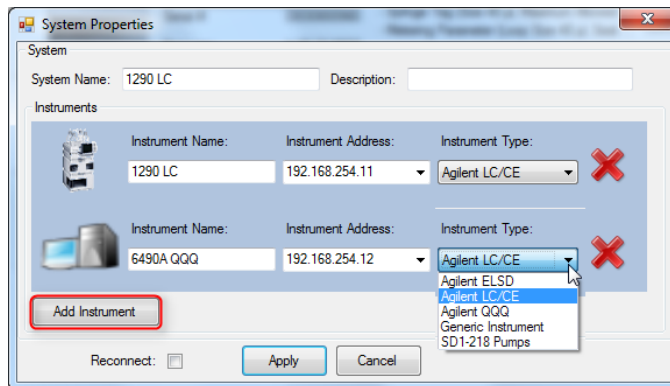
- Click the **Instrument Type** down-arrow and select the type of instrument you are adding from the list. The default setting is **Agilent LC/CE**. Additional instrument types become available when the respective add-ons are installed.



**NOTE**

By default, the **Instrument Type** drop-down list contains only the entry **Agilent LC/CE**. Additional instrument types can be added by installing the respective add-ons (see “Installing Add-ons” on page 45).

- If your system comprises more than one instrument, click **Add Instrument** and complete the details as above.



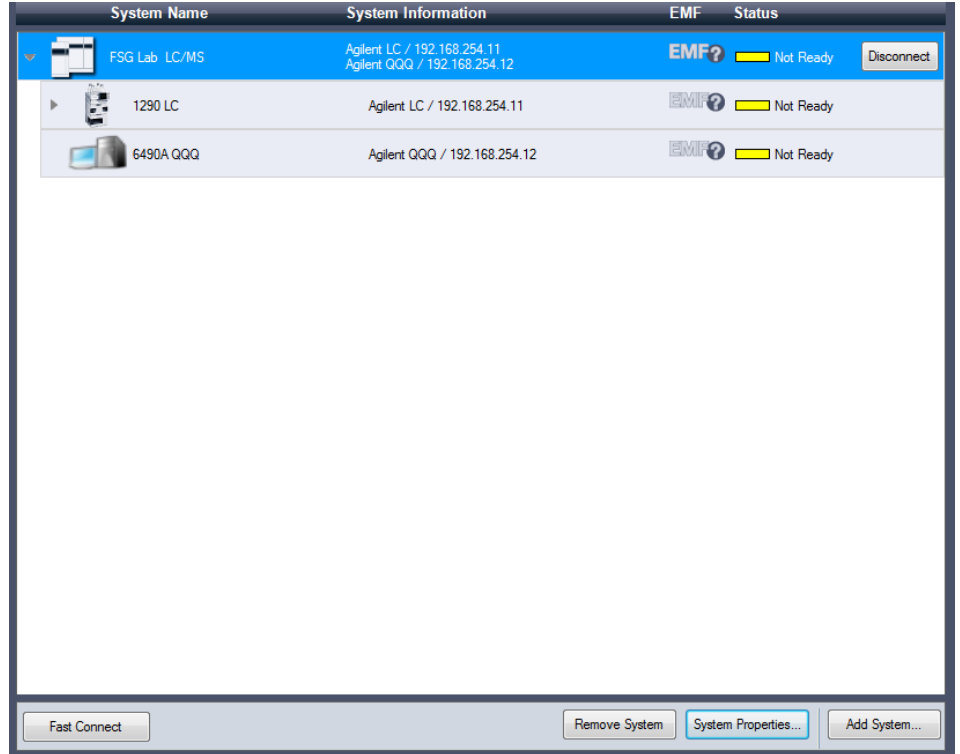
**NOTE**

As soon as you add a second instrument, the **System Name** field is activated to allow you to edit the system name.

## 2 Configuration Settings

### Lab Advisor

- Click **OK** to finish adding the system and close the **Add System** dialog box. The system becomes visible in the **System Overview**, and Lab Advisor tries to connect to it.



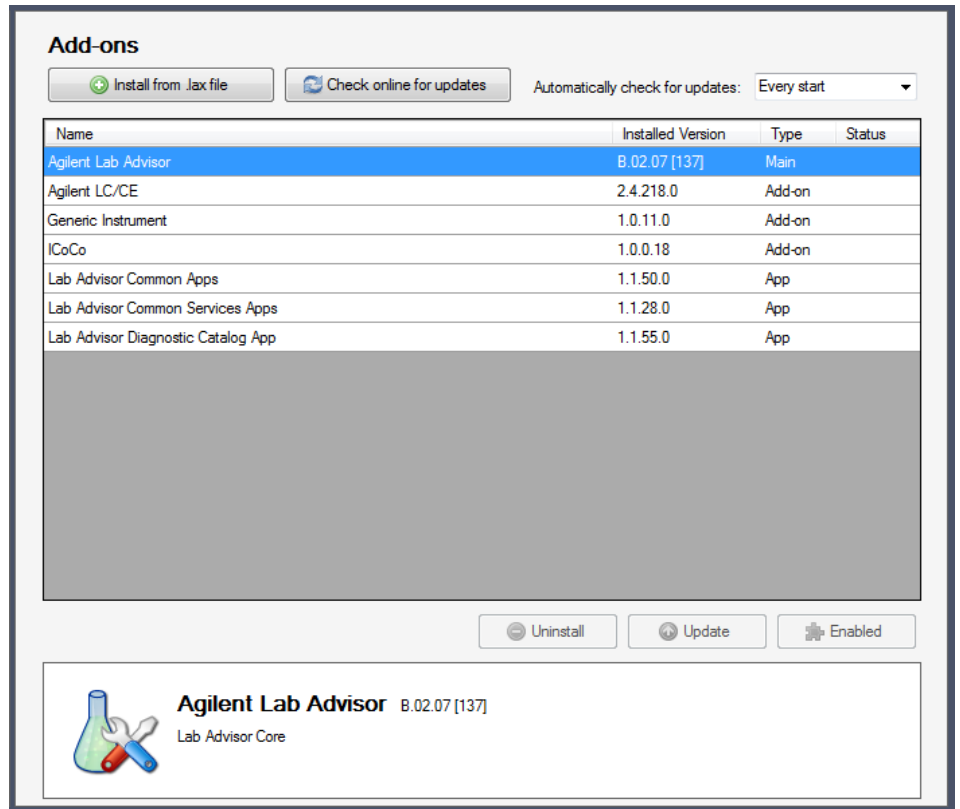
## Installing Add-ons

Add-ons are installed from the **Configuration** screen, using a Lab Advisor Extension file with the with the extension .LAX.

### NOTE

You need Administrator rights in order to install Add-ons.

- 1 In the Global Tasks section of the Navigation Panel, click **Configuration**. The **Configuration** screen is displayed.
- 2 Click **Add-ons** to navigate to the **Configuration - Add-ons** screen.



**Figure 24** Add-ons in Configuration

## 2 Configuration Settings

### Lab Advisor

The **Configuration - Add-ons** screen contains a table listing all the Add-ons that are already installed.

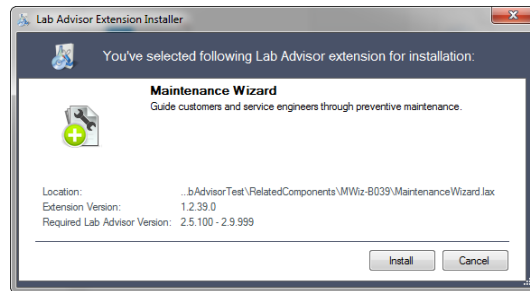
**3** Click **Install from .lax file**.

A file selection dialog box is displayed to allow you to select the App or Add-on to install.

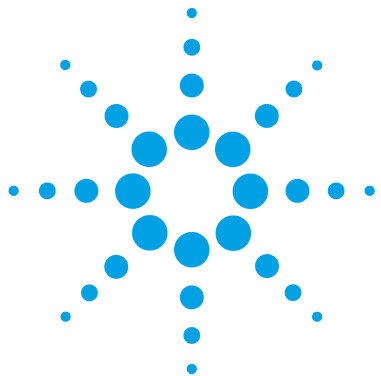
**4** Navigate to the folder containing the Add-on files, select the .lax file and click **Open** to install the Add-on.

**5** Click **Yes** when the request to shut down Lab Advisor appears.

Lab Advisor shuts down and the Add-on installation is started.



When the installation is finished, the newly installed Add-on is included in the table in the **Configuration - Add-ons** screen.



### 3 Quick Start Guide

Best Practices	48
Prepare a Run	49
Check Out the System	56
Checkout Method	56
Setup the Checkout Method	61

This chapter provides information on running an Agilent 1260 Infinity II LC System.



## Best Practices

**NOTE**

For best practices, refer to the *Agilent Information Center* on Agilent InfinityLab LC Series User Documentation (G4800-64600) or the 1290 Infinity Pump Quick Reference Sheet (01200-90091).

---



## Prepare a Run

This procedure exemplarily shows how to prepare a run. Parameters as shown in the screenshots may vary, depending on the system installed.

### WARNING

**Toxic, flammable and hazardous solvents, samples and reagents**

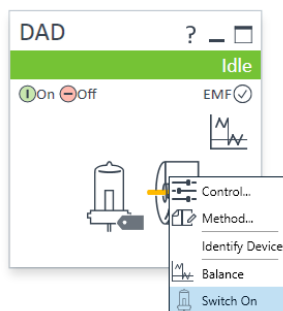
**The handling of solvents, samples and reagents can hold health and safety risks.**

- When working with these substances observe appropriate safety procedures (for example by wearing goggles, safety gloves and protective clothing) as described in the material handling and safety data sheet supplied by the vendor, and follow good laboratory practice.
  - Do not use solvents with an auto-ignition temperature below 200 °C (392 °F). Do not use solvents with a boiling point below 56 °C (133 °F).
  - Avoid high vapor concentrations. Always keep the temperature in the sample compartment at least 25 K below the boiling point of the solvent used.
  - Do not operate the instrument in an explosive atmosphere.
  - Reduce the volume of substances to the minimum required for the analysis.
  - Never exceed the maximum permissible volume of solvents (8 L) in the solvent cabinet. Do not use bottles that exceed the maximum permissible volume as specified in the usage guideline for solvent cabinet.
  - Ground the waste container.
  - Regularly check the filling level of the waste container. The residual free volume in the waste container must be large enough to collect the waste liquid.
  - To achieve maximal safety, regularly check the tubing for correct installation.
-

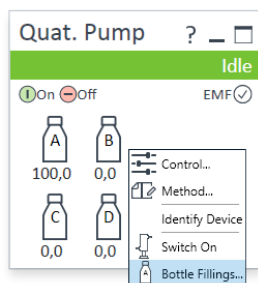
### 3 Quick Start Guide

#### Prepare a Run

- 1 Switch on the detector.



- 2 Fill the solvent bottles with adequate solvents for your application.
- 3 Place solvent tubings with bottle head assemblies into the solvent bottles.
- 4 Place solvent bottles into the solvent cabinet.
- 5 Solvent bottle filling dialog (in the software).



Solvent Bottle					
Fillings					
	Actual Volume		Total Volume		
A:	<input type="text" value="0.80"/>	liter	<input type="text" value="1.00"/>	liter	
B:	<input type="text" value="0.92"/>	liter	<input type="text" value="1.00"/>	liter	
C:	<input type="text" value="0.78"/>	liter	<input type="text" value="1.00"/>	liter	
D:	<input type="text" value="0.81"/>	liter	<input type="text" value="1.00"/>	liter	

Actions		
<input checked="" type="checkbox"/>	Prevent analysis if level falls below	<input type="text" value="0.05"/> liter
<input type="checkbox"/>	Turn pump off if running out of solvent	

Ok Cancel Help

**6** Purge the pump (in normal usage scenario).

OR

Prime the pump (after installation of the system).

**NOTE**

For details on priming and purging, refer to the technical note *Best Practices for Using an Agilent LC System*.

**7** Change solvent (if necessary).

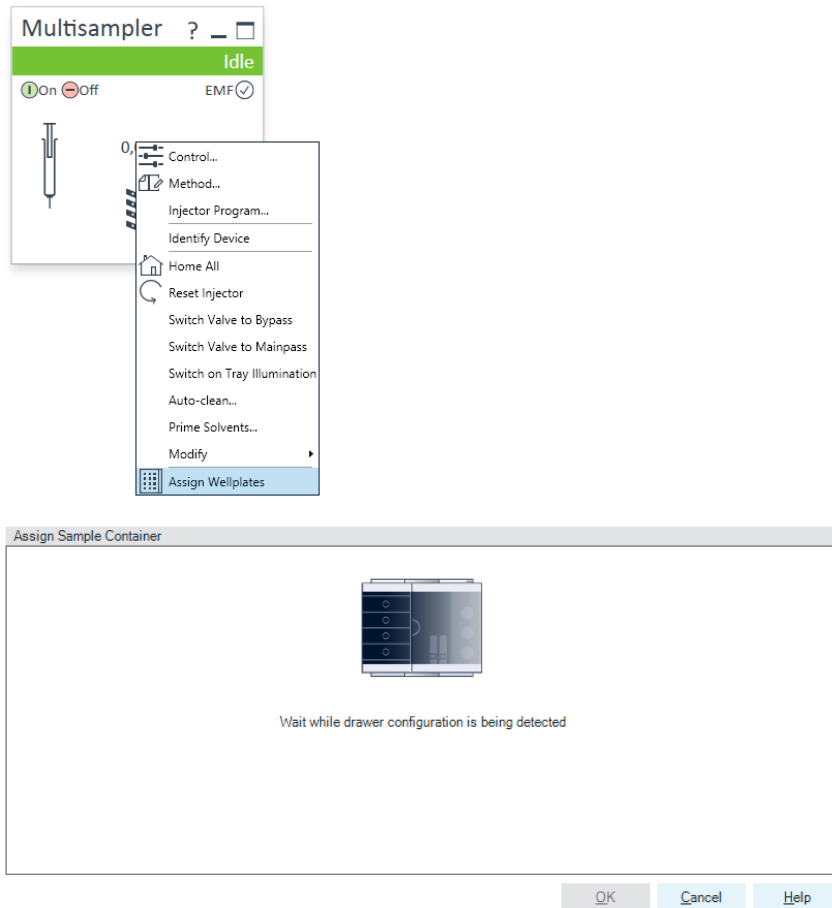
The screenshot displays the software interface for the Quat. Pump (G7111B). The interface is divided into several sections:

- Flow:** A text box shows a flow rate of 0.800 mL/min.
- Solvents:** A list of solvents A, B, C, and D. Solvent A is Water at 60.0%. Solvent B is Acetonitrile at 40.0%. Solvents C and D are currently at 0.0%.
- Pressure Limits:** Minimum pressure is set to 0.00 bar and maximum pressure is set to 600.00 bar.
- Stoptime/Posttime:** Stoptime is set to 10.00 min (selected) and Posttime is set to 1.00 min (selected).
- Advanced Settings:**
  - Minimum Stroke:** Set to Automatic (selected) or 20 µL.
  - Compressibility:** Set to 95 × 10<sup>-6</sup> / bar (selected) or No compensation.
  - Maximum Flow Gradient:** Set to 100.000 mL/min<sup>2</sup>.
  - Primary Channel:** Set to Automatic.
- Import Timetable...:** A button to import a timetable.
- Timetable (1/100 events):** A scrollable list of events.

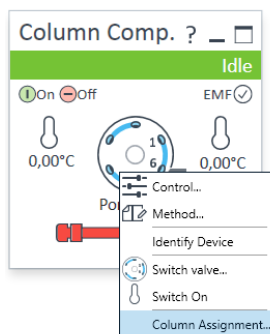
### 3 Quick Start Guide

#### Prepare a Run

8 Choose the tray format of the sampler.



**9** Add a new column.



**10** Enter the column information.

**Plumbing**

Valve Position	Location
1	Left 1
2	Left 2

**Visualization**

Valve Type: 2-pos/6-port valve 600 bar (5067-4137)

---

**Column Tag Information** >>

Location	Color Code	Description	Length [mm]	Diameter [mm]	Particle Size [µm]	Max. Pressure [bar]	Injections
Left 1	Red		0	0,0	0,0	0	0
▶ Left 2	Blue		0	0,0	0,0	0	0
Left 3	None		0	0,0	0,0	0	0
Left 4	None		0	0,0	0,0	0	0
Right 1	None		0	0,0	0,0	0	0
Right 2	None		0	0,0	0,0	0	0
Right 3	None		0	0,0	0,0	0	0
Right 4	None		0	0,0	0,0	0	0

Qk/Write Tag
Cancel
Help

### 3 Quick Start Guide

#### Prepare a Run

## 11 Select the column position.

**Temperature**


Left:  Not Controlled  40.0 °C  As Detector Cell  Unchanged

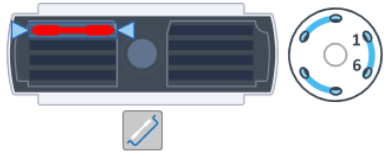
Right:  Not Controlled  25.0 °C  As Detector Cell  Unchanged  Combined

**Valve Position/Column**

Use Current Column / Position

Use Selected Column / Position

Position 1 



Enforce column for run

**Stoptime**  As Pump/Injector  1.00 min

**Posttime**  Off  1.00 min

**Advanced**

**Enable Analysis**

when front door open

Left:  With any temperature  When temperature is within ± 0.8 °C for 0.0 min

Right:  With any temperature  When temperature is within ± 0.8 °C for 0.0 min

**Valve Position/Column After Run**

Do not switch

Switch to position / column at beginning of run

Increase valve position / column

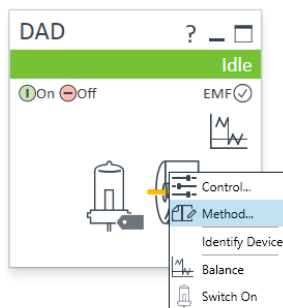
Use valve position / column

Position 1


Timetable (empty)

Ok Apply Cancel

**12** Set the detector according to the needs of your method.



Quat. Pump | VWD | Sampler | **DAD** | Column Comp.

**DAD (G7115A)** 

Signals	Acquire	Wave length	Band width	Reference Wavelength	Reference Bandwidth	
Signal A	<input checked="" type="checkbox"/>	254	4	360	100	nm
Signal B	<input type="checkbox"/>	254	4	360	100	nm
Signal C	<input type="checkbox"/>	210	4	360	100	nm
Signal D	<input type="checkbox"/>	230	4	360	100	nm
Signal E	<input type="checkbox"/>	280	4	360	100	nm
Signal F	<input type="checkbox"/>	260	4	360	100	nm
Signal G	<input type="checkbox"/>	270	4	360	100	nm
Signal H	<input type="checkbox"/>	290	4	360	100	nm

Peakwidth  
> 0.0063 min (0.13 s response time) (40 Hz)

Stoptime | Posttime

As Pump/Injector       Off  
 1.00 min       1.00 min

**Advanced**

Spectrum  
Store: None  
Range from: 190 to 400 nm  
Step: 2.0 nm

Analog Output  
Zero Offset: 5 %  
Attenuation: 1000 mAU

Margin for negative Absorbance      Slit  
100 mAU      4 nm

Autobalance      Lamps on required for acquisition  
 Prerun       UV Lamp  
 Postrun       Vis Lamp

Timetable (empty)

**NOTE**

For details on running a method, see “Setup the Checkout Method” on page 61 as an example.

## Check Out the System

### Checkout Method

This is an exemplary method for the Agilent InfinityLab LC Series.

Exemplary configuration:

- Quaternary Pump G7111B
- Multisampler G7167A
- Multicolumn Thermostat G7116A
- Diode Array Detector WR G7115A

The RRLC checkout sample (5188-6529) serves as standard for systems with 600 bar and contains 100 ng/ $\mu$ L each of nine components dissolved in water / acetonitrile (65/35). The nine components are:

- Acetanilide
- Acetophenone
- Propiophenone
- Butyrophenone
- Benzophenone
- Valerophenone
- Hexanophenone
- Heptanophenone
- Octanophenone

The Agilent isocratic checkout sample (01080-68704) serves as standard for systems with 400 bar and contains each of four components dissolved in methanol.

- Dimethylphthalate
- Diethylphthalate
- Biphenyl
- o-Terphenyl



**NOTE**

Find the correct settings for the individual modules here:

- Checkout method parameter settings Isocratic Pump (G7110B) (Table 3 on page 58)
- Checkout method parameter settings Quaternary Pump VL (G7111A) (Table 4 on page 58)
- Checkout method parameter settings Quaternary Pump (G7111B) (Table 5 on page 59)
- Checkout method parameter settings Multisampler (G7167A) or Vialsampler (G7129A) (Table 6 on page 59)
- Checkout method parameter settings Multicolumn Thermostat (G7116A) (Table 7 on page 59)
- Checkout method parameter settings Diode Array Detector HS (G7117C) or Diode Array Detector WR (G7115A) (Table 8 on page 60)
- Checkout method parameter settings Variable Wavelength Detector (G7114A) (Table 9 on page 60)

**Table 2** Overview of column options for different pumps

Pump	Option 1	Option 2	Option 3
1260 Infinity II Quaternary and Binary Pump (G7111B/G7112B)	Poroshell 120 EC-C18, 4.6 x 100 mm, 2.7 µm	Poroshell 120 EC-C18, 3.0 x 150, 2.7 µm	Poroshell 120 EC-C18, 3.0 x 50 mm, 2.7 µm
	695975-902T	693975-302T	699975-302T
1260 Infinity II Quaternary Pump VL (G7111A)	Poroshell 120 EC-C18, 4.6 x 100 mm, 4 µm	Poroshell 120 EC-C18, 4.6 x 50 mm, 2.7 µm	Poroshell 120 EC-C18, 4.6 x 150 mm, 4 µm
	695970-902T	699975-902T	693970-902T

### 3 Quick Start Guide

#### Check Out the System

**Table 3** Checkout method parameter settings Isocratic Pump (G7110B)

Parameter	Value
Flow	1.5 mL/min
Solvents	65 % ACN in water
Compressibility	75
Stoptime	10 min
Pressure Limit	600 bar
Minimum Stroke	Automatic

**Table 4** Checkout method parameter settings Quaternary Pump VL (G7111A)

Parameter	Value
Flow	1 mL/min
Solvent A	Water
Solvent B	ACN
Compressibility	75
Composition	65 % B (ACN)
Composition	35 % A (Water)
Stoptime	10 min
Pressure Limit	400 bar
Minimum Stroke	Automatic

**Table 5** Checkout method parameter settings Quaternary Pump (G7111B)

Parameter	Value
Flow	0.8 mL/min
Solvent A	Water
Solvent B	ACN
Compressibility	95
Composition	40 %B (ACN)
Composition	60 %A (Water)
Stoptime	10 min
Pressure Limit	600 bar
Minimum Stroke	Automatic
Timetable	2.5 min 80 %B

**Table 6** Checkout method parameter settings Vialsampler/Multisampler (G7129A/G7167A)

Parameter	Value
Injection	1 µL
Stoptime	as pump
Draw speed	100 µL/min

**Table 7** Checkout method parameter settings Multicolumn Thermostat (G7116A)

Parameter	Value
Temperature (left)	40 °C
Temperature (right)	combined
Stoptime	as pump

### 3 Quick Start Guide

#### Check Out the System

**Table 8** Checkout method parameter settings Diode Array Detectors (G7115A/G7117C)

Parameter	Value
Signal A	254/4 nm
Ref A	360/100 nm
Peakwidth	40 Hz
Stoptime	as pump
Spectrum	None
Autobalance	Prerun

**Table 9** Checkout method parameter settings Variable Wavelength Detector (G7114A)

Parameter	Value
Wavelength	254 nm
Peakwidth	40 Hz
Stoptime	as pump
Autobalance	Prerun

## Setup the Checkout Method

### NOTE

The setup of the checkout method in this procedure is an example. For the individual module parameters, see “[Checkout Method](#)” on page 56.

---

- 1 Turn on the lamp.
- 2 Load the the default method DEF\_LC.M

### 3 Quick Start Guide

Check Out the System


### 3 Change the method and timetable settings for the 1260 Infinity II Quaternary Pump (G7111B)

The screenshot displays the software interface for the Quat. Pump (G7111B). The interface is divided into several sections:

- Flow:** A text box showing a flow rate of 0.800 mL/min.
- Solvents:** A list of four solvent channels (A, B, C, D) with percentage and name input fields. Channel A is set to 60.0% Water, and Channel B is checked and set to 40.0% Acetonitrile. Channels C and D are set to 0.0%.
- Pressure Limits:** Min: 0.00 bar, Max: 600.00 bar.
- Stoptime/Posttime:** Stoptime is set to 10.00 min (selected with a radio button). Posttime is set to 1.00 min (selected with a radio button).
- Advanced:** A panel on the right containing:
  - Minimum Stroke:** Radio button for Automatic (selected) and a text box for 20 µL.
  - Compressibility:** Radio button for 95 \*10<sup>-6</sup> / bar (selected) and a radio button for No compensation.
  - Maximum Flow Gradient:** A text box showing 100.000 mL/min<sup>2</sup>.
  - Primary Channel:** A dropdown menu set to Automatic.
- Import Timetable...:** A button at the bottom left of the main panel.
- Timetable (1/100 events):** A scrollable area at the bottom right showing a single event.

**Figure 25** Method settings 1260 Infinity II Quaternary Pump (G7111B)

Quat. Pump VWD Sampler DAD Column Comp.

**Quat. Pump (G7111B)** 

**Flow**  
0.800 mL/min

**Solvents**

A: 60.0 % Water

B:  40.0 % Acetonitrile

C:  0.0 %

D:  0.0 %

**Pressure Limits**  
Min: 0.00 bar Max: 600.00 bar

**Stoptime** **Posttime**

As Injector/No Limit  Off

10.00 min  1.00 min

Import Timetable...

**Advanced**

Timetable (1/100 events)  function centric view

Time [min]	A [%]	B [%]	C [%]	D [%]	Flow [mL/min]	Max. Pressure Limit [bar]
0.00	60.0	40.0	0.0	0.0	0.800	600.00
2.50	20.0	80.0	0.0	0.0	---	---

Add Remove Clear All Clear Empty

Cut Copy Paste Shift Times 0.00

**Figure 26** Timetable settings 1260 Infinity II Quaternary Pump (G7111B)

### 3 Quick Start Guide

#### Check Out the System

#### 4 Change the method settings for the 1260 Infinity II Multisampler (G7167A)


The screenshot displays the software interface for the Multisampler (G7167A). The top navigation bar includes tabs for Quat. Pump, VWD, Sampler, DAD, Column Comp., Multisampler, Iso. Pump, Quat. Pump, Binary Pump, and Multisampler. The main window is titled "Multisampler (G7167A)" and is divided into several sections:

- Injection:** Injection volume: 1.00  $\mu\text{L}$
- Needle Wash:** Standard Wash (dropdown menu)
- Stoptime:** As Pump/No Limit (selected), 1.00 min
- Posttime:** Off (selected), 1.00 min
- Advanced:**
  - Sampling Speed:** Draw Speed: 100.0  $\mu\text{L}/\text{min}$ ; Eject Speed: 400.0  $\mu\text{L}/\text{min}$ ; Wait Time After Draw: 1.2 s
  - Needle Height Position:** Offset: 0.0 mm; Use Vial/Well Bottom Sensing (checkbox)
  - High Throughput:** Sample Flush-Out Factor: 5.0; Injection Valve to Bypass for Delay Volume Reduction (checkbox); Enable Overlapped Injection (checkbox); When Sample is Flushed Out (radio button); After Period of Time (selected), 0.00 minutes after injection
- Injection Path Cleaning:** (dropdown menu)

**Figure 27** Method setting 1260 Infinity II Multisampler (G7167A)



Quat. Pump | VWD | Sampler | DAD | Column Comp. | Multisampler | Iso. Pump | Quat. Pump | Binary Pump | Multisampler

**Multisampler (G7167A)** 

**Injection**

Injection volume:   $\mu\text{L}$

**Needle Wash**

**Stoptime** | **Posttime**

As Pump/No Limit       Off  
  min        min

**Advanced**

**Injection Path Cleaning**

**Standard Wash**

Mode:

Time:  s

Location:

Repeat:

**Multi-wash**

Step	Solvent	Time [s]	Seat Back Flush	Needle Wash	Comment
1	Off		<input type="checkbox"/>	<input type="checkbox"/>	
2	Off		<input type="checkbox"/>	<input type="checkbox"/>	
3	Off		<input type="checkbox"/>	<input type="checkbox"/>	
Start Cond.	S1		<input checked="" type="checkbox"/>	<input type="checkbox"/>	

**Figure 28** Method setting 1260 Infinity II Multisampler (G7167A) - Injection Path Cleaning

### 3 Quick Start Guide

#### Check Out the System

## 5 Change the method settings for the 1260 Infinity II Multicolumn Thermostat (G7116A)

Temperature

Left:  Not Controlled  40.0 °C  As Detector Cell  Unchanged

Right:  Not Controlled  25.0 °C  As Detector Cell  Unchanged  Combined

Valve Position/Column

Use Current Column / Position

Use Selected Column / Position

Position 1

Enforce column for run

Stoptime  As Pump/Injector  1.00 min

Posttime  Off  1.00 min

Advanced

Enable Analysis

when front door open

Left:  With any temperature  When temperature is within ± 0.8 °C for 0.0 min

Right:  With any temperature  When temperature is within ± 0.8 °C for 0.0 min

Valve Position/Column After Run

Do not switch

Switch to position / column at beginning of run

Increase valve position / column

Use valve position / column

Position 1


Timetable (empty)

Ok Apply Cancel

**Figure 29** Method setting 1260 Infinity II Multicolumn Thermostat (G7116A)

## 6 Change the method settings for the 1260 Infinity II Diode Array Detector WR (G7115A)

Quat. Pump | VWD | Sampler | **DAD** | Column Comp.

**DAD (G7115A)** 

**Signals**

	Acquire	Wave length	Band width	Reference Wavelength	Reference Bandwidth	
Signal A	<input checked="" type="checkbox"/>	254	4	<input checked="" type="checkbox"/> 360	100	nm
Signal B	<input type="checkbox"/>	254	4	<input type="checkbox"/> 360	100	nm
Signal C	<input type="checkbox"/>	210	4	<input type="checkbox"/> 360	100	nm
Signal D	<input type="checkbox"/>	230	4	<input type="checkbox"/> 360	100	nm
Signal E	<input type="checkbox"/>	280	4	<input type="checkbox"/> 360	100	nm
Signal F	<input type="checkbox"/>	260	4	<input type="checkbox"/> 360	100	nm
Signal G	<input type="checkbox"/>	270	4	<input type="checkbox"/> 360	100	nm
Signal H	<input type="checkbox"/>	290	4	<input type="checkbox"/> 360	100	nm

**Peakwidth**

> 0.0063 min (0.13 s response time) (40 Hz)

**Stoptime**      **Posttime**

As Pump/Injector       Off

1.00 min       1.00 min

**Advanced**

**Spectrum**

Store: None

Range from: 190 to 400 nm

Step: 2.0 nm

**Analog Output**

Zero Offset: 5 %

Attenuation: 1000 mAU

**Margin for negative Absorbance**      **Slit**

100 mAU      4 nm

**Autobalance**      **Lamps on required for acquisition**

Prerun       UV Lamp

Postrun       Vis Lamp

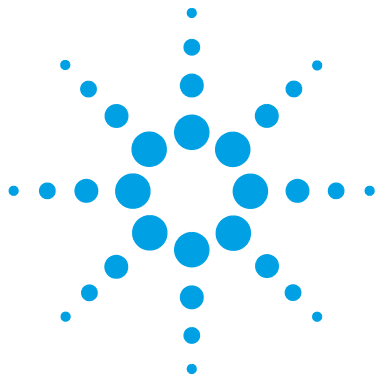
▶ Timetable (empty)

**Figure 30** Method setting 1260 Infinity II Diode Array Detector WR (G7115A)

- 7 Save the method as GRAD-1.M
- 8 Equilibrate the system for 10 min under checkout conditions
- 9 Run and evaluate the checkout method

### **3 Quick Start Guide**

**Check Out the System**



## 4 Parts and Consumables

Tool Kit	70
A-Line Quick Connect and Quick Turn Fittings	72
A-Line Quick Connect Fittings	72
A-Line Quick Connect Fitting Replacement Capillaries	73
A-Line Quick Turn Fitting	74
Capillaries for use with the A-Line Quick Turn Fitting	75

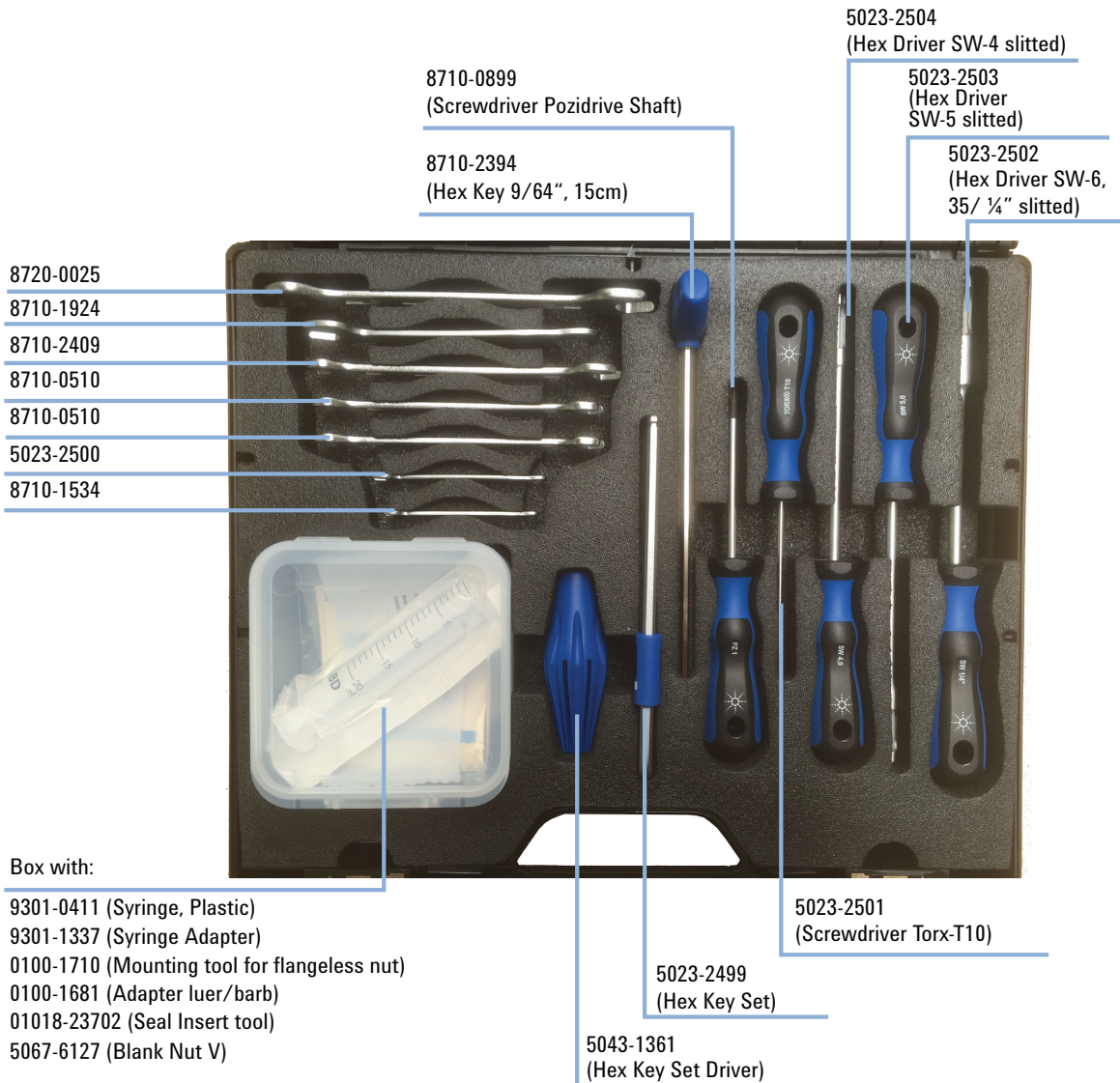
This chapter provides information on additional parts and consumables.



# Tool Kit

The HPLC System Tool Kit contains all tools to operate and maintain a 1260 Infinity II LC system.

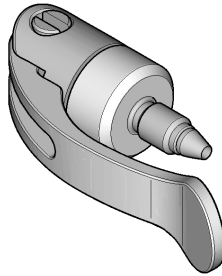
The High quality tools are packed in an appealing tool case.



**Figure 31** Tool kit

## A-Line Quick Connect and Quick Turn Fittings

### A-Line Quick Connect Fittings



**Figure 32** A-Line Quick Connect Fitting

<b>p/n</b>	<b>Description</b>
5067-5965	A-Line Quick Connect LC fitting (fitting without pre-installed capillary)
5067-5961	A-Line Quick Connect Assy ST 0.075 mm x 105 mm
5067-6163	A-Line Quick Connect Assy ST 0.075 mm x 150 mm
5067-6164	A-Line Quick Connect Assy ST 0.075 mm x 220 mm
5067-6165	A-Line Quick Connect Assy ST 0.075 mm x 280 mm (fitting without pre-installed capillary)
5067-5957	A-Line Quick Connect Assy ST 0.12 mm x 105 mm
5067-5958	A-Line Quick Connect Assy ST 0.12 mm x 150 mm
5067-5959	A-Line Quick Connect Assy ST 0.12 mm x 220 mm
5067-5960	A-Line Quick Connect Assy ST 0.12 mm x 280 mm
5067-6166	A-Line Quick Connect Assy ST 0.17 mm x 105 mm
5067-6167	A-Line Quick Connect Assy ST 0.17 mm x 150 mm
5067-6168	A-Line Quick Connect Assy ST 0.17 mm x 220 mm
5067-6169	A-Line Quick Connect Assy ST 0.17 mm x 280 mm

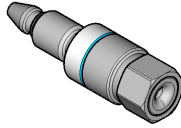


## A-Line Quick Connect Fitting Replacement Capillaries

<b>p/n</b>	<b>Description</b>
5500-1174	A-Line Capillary ST 0.075 mm x 105 mm
5500-1175	A-Line Capillary ST 0.075 mm x 150 mm
5500-1176	A-Line Capillary ST 0.075 mm x 220 mm
5500-1177	A-Line Capillary ST 0.075 mm x 250 mm
5500-1178	A-Line Capillary ST 0.075 mm x 280 mm
5500-1173	A-Line Capillary ST 0.12 mm x 105 mm
5500-1172	A-Line Capillary ST 0.12 mm x 150 mm
5500-1171	A-Line Capillary ST 0.12 mm x 220 mm
5500-1170	A-Line Capillary ST 0.12 mm x 280 mm
5500-1179	A-Line Capillary ST 0.12 mm x 400 mm
5500-1180	A-Line Capillary ST 0.12 mm x 500 mm
5500-1181	A-Line Capillary ST 0.17 mm x 105 mm
5500-1182	A-Line Capillary ST 0.17 mm x 150 mm
5500-1183	A-Line Capillary ST 0.17 mm x 220 mm
5500-1230	A-Line Capillary ST 0.17 mm x 280 mm
5500-1231	A-Line Capillary ST 0.17 mm x 500 mm

**4** **Parts and Consumables**  
A-Line Quick Connect and Quick Turn Fittings

## A-Line Quick Turn Fitting



**Figure 33** A-Line Quick Turn Fitting

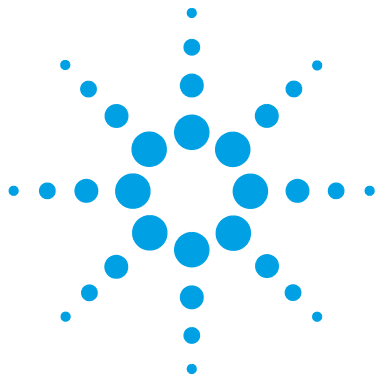
<b>p/n</b>	<b>Description</b>
5067-5966	A-Line Quick Turn fitting

## Capillaries for use with the A-Line Quick Turn Fitting

<b>p/n</b>	<b>Description</b>
5500-1198	Capillary ST 0.075 mm x 105 mm, long socket
5500-1232	Capillary ST 0.075 mm x 150 mm, long socket
5500-1188	Capillary ST 0.12 mm x 105 mm, long socket
5500-1189	Capillary ST 0.12 x 150 mm, long socket
5500-1233	Capillary ST 0.12 mm x 180 mm, long socket
5500-1190	Capillary ST 0.12 mm x 200 mm, long socket
5500-1191	Capillary ST 0.12 mm x 280 mm, long socket
5500-1192	Capillary ST 0.12 mm x 500 mm, long socket
5500-1193	Capillary ST 0.17 mm x 105 mm, long socket
5500-1194	Capillary ST 0.17 mm x 150 mm, long socket
5500-1234	Capillary ST 0.17 mm x 180 mm, long socket
5500-1195	Capillary ST 0.17 mm x 200 mm, long socket
5500-1196	Capillary ST 0.17 mm x 280 mm, long socket
5500-1235	Capillary ST 0.17 mm x 380 mm, long socket
5500-1236	Capillary ST 0.17 mm x 400 mm, long socket
5500-1197	Capillary ST 0.17 mm x 500 mm, long socket

## **4 Parts and Consumables**

### **A-Line Quick Connect and Quick Turn Fittings**



## 5 Appendix

Safety	78
General Safety Information	78
Safety Standards	78
General	78
Before Applying Power	79
Ground the Instrument	79
Do Not Operate in an Explosive Atmosphere	80
Do Not Remove the Instrument Cover	80
Do Not Modify the Instrument	80
In Case of Damage	80
Solvents	81
Symbols	82
Agilent Technologies on Internet	84

This chapter provides addition information on safety, legal, and web.



## Safety

### General Safety Information

The following general safety precautions must be observed during all phases of operation, service, and repair of this instrument. Failure to comply with these precautions or with specific warnings elsewhere in this manual violates safety standards of design, manufacture, and intended use of the instrument. Agilent Technologies assumes no liability for the customer's failure to comply with these requirements.

#### **WARNING**

**Ensure the proper usage of the equipment.**

**The protection provided by the equipment may be impaired.**

→ The operator of this instrument is advised to use the equipment in a manner as specified in this manual.

---

### Safety Standards

This is a Safety Class I instrument (provided with terminal for protective earthing) and has been manufactured and tested according to international safety standards.

### General

Do not use this product in any manner not specified by the manufacturer. The protective features of this product may be impaired if it is used in a manner not specified in the operation instructions.

## Before Applying Power

**WARNING****Wrong voltage range, frequency or cabling****Personal injury or damage to the instrument**

- Verify that the voltage range and frequency of your power distribution matches to the power specification of the individual instrument.
  - Never use cables other than the ones supplied by Agilent Technologies to ensure proper functionality and compliance with safety or EMC regulations.
  - Make all connections to the unit before applying power.
- 

**NOTE**

Note the instrument's external markings described under “[Symbols](#)” on page 82.

---

## Ground the Instrument

**WARNING****Missing electrical ground****Electrical shock**

- If your product is provided with a grounding type power plug, the instrument chassis and cover must be connected to an electrical ground to minimize shock hazard.
  - The ground pin must be firmly connected to an electrical ground (safety ground) terminal at the power outlet. Any interruption of the protective (grounding) conductor or disconnection of the protective earth terminal will cause a potential shock hazard that could result in personal injury.
-

## Do Not Operate in an Explosive Atmosphere

### WARNING

**Presence of flammable gases or fumes**

**Explosion hazard**

→ Do not operate the instrument in the presence of flammable gases or fumes.

---

## Do Not Remove the Instrument Cover

### WARNING

**Instrument covers removed**

**Electrical shock**

→ Do Not Remove the Instrument Cover

→ Only Agilent authorized personnel are allowed to remove instrument covers. Always disconnect the power cables and any external circuits before removing the instrument cover.

---

## Do Not Modify the Instrument

Do not install substitute parts or perform any unauthorized modification to the product. Return the product to an Agilent Sales and Service Office for service and repair to ensure that safety features are maintained.

## In Case of Damage

### WARNING

**Damage to the module**

**Personal injury (for example electrical shock, intoxication)**

→ Instruments that appear damaged or defective should be made inoperative and secured against unintended operation until they can be repaired by qualified service personnel.

---



## Solvents

**WARNING**

**Toxic, flammable and hazardous solvents, samples and reagents**

**The handling of solvents, samples and reagents can hold health and safety risks.**










- When working with these substances observe appropriate safety procedures (for example by wearing goggles, safety gloves and protective clothing) as described in the material handling and safety data sheet supplied by the vendor, and follow good laboratory practice.
- Do not use solvents with an auto-ignition temperature below 200 °C (392 °F). Do not use solvents with a boiling point below 56 °C (133 °F).
- Avoid high vapor concentrations. Always keep the temperature in the sample compartment at least 25 K below the boiling point of the solvent used.
- Do not operate the instrument in an explosive atmosphere.
- Reduce the volume of substances to the minimum required for the analysis.
- Never exceed the maximum permissible volume of solvents (8 L) in the solvent cabinet. Do not use bottles that exceed the maximum permissible volume as specified in the usage guideline for solvent cabinet.
- Ground the waste container.
- Regularly check the filling level of the waste container. The residual free volume in the waste container must be large enough to collect the waste liquid.
- To achieve maximal safety, regularly check the tubing for correct installation.

**NOTE**




For details, see the usage guideline for the solvent cabinet. A printed copy of the guideline has been shipped with the solvent cabinet, electronic copies are available in the Agilent Information Center or via the Internet.

## Symbols

Table 10 Symbols

	The apparatus is marked with this symbol when the user should refer to the instruction manual in order to protect risk of harm to the operator and to protect the apparatus against damage.
	Indicates dangerous voltages.
	Indicates a protected ground terminal.
	The apparatus is marked with this symbol when hot surfaces are available and the user should not touch it when heated up.
	Cooling unit is designed as vapor-compression refrigeration system. Contains fluorinated greenhouse gas (refrigerant) according to the Kyoto protocol. For specifications of refrigerant, charge capacity, carbon dioxide equivalent (CDE), and global warming potential (GWP) see instrument label.
	Confirms that a manufactured product complies with all applicable European Community directives. The European Declaration of Conformity is available at: <a href="http://regulations.corporate.agilent.com/DoC/search.htm">http://regulations.corporate.agilent.com/DoC/search.htm</a>
	Manufacturing date.
	Power symbol indicates On/Off. The apparatus is not completely disconnected from the mains supply when the power switch is in the Off position
	Pacemaker Magnets could affect the functioning of pacemakers and implanted heart defibrillators. A pacemaker could switch into test mode and cause illness. A heart defibrillator may stop working. If you wear these devices keep at least 55 mm distance to magnets. Warn others who wear these devices from getting too close to magnets.

**Table 10** Symbols

	<p>Magnetic field Magnets produce a far-reaching, strong magnetic field. They could damage TVs and laptops, computer hard drives, credit and ATM cards, data storage media, mechanical watches, hearing aids and speakers. Keep magnets at least 25 mm away from devices and objects that could be damaged by strong magnetic fields.</p>
	<p>Indicates a pinching or crushing hazard</p>
	<p>Indicates a piercing or cutting hazard.</p>

**WARNING**

**A WARNING**

alerts you to situations that could cause physical injury or death.

- Do not proceed beyond a warning until you have fully understood and met the indicated conditions.

**CAUTION**

**A CAUTION**

alerts you to situations that could cause loss of data, or damage of equipment.

- Do not proceed beyond a caution until you have fully understood and met the indicated conditions.

## **Agilent Technologies on Internet**

For the latest information on products and services visit our worldwide web site on the Internet at:

<http://www.agilent.com>

# Index

## A

add system 41  
 Agilent  
   on internet 84

## B

best practices 48

## C

checkout  
   method 61  
   setup 61  
 COM port 42  
 components 8  
 connection details 42

## D

description  
   product 6  
 detector  
   diode array 15, 16  
   fluorescence 18

## H

host name 42

## I

instrument address 42  
 instrument name 42  
 instrument type 43  
 internet 84  
 IP address 42

## N

new system 41

## O

overview 12, 15, 17

## P

practices  
   best 48  
 prepare  
   run 49  
 product description  
   G7129A 13  
 product  
   description 6  
 pump  
   isocratic 11  
   quaternary VL 9, 10

## R

run  
   prepare 49

## S

safety class I 78  
 safety  
   general information 78  
   symbols 82  
 system name 42

## T

thermostat  
   multicolumn 14

tool  
   kit 70  
 type 43

[www.agilent.com](http://www.agilent.com)

## In This Book

This manual contains technical reference information about the Agilent InfinityLab LC Series 1260 Infinity II Quaternary System.

The manual describes the following:

- introduction,
- product description,
- best practices,
- system optimization,
- quick start guide.

© Agilent Technologies 2016

Printed in Germany  
04/2016



G7111-90300



**Agilent Technologies**