



Thermo Scientific

## Sorvall ST 8 / 8R Centrifuge

### Instruction Manual

50143327-b • 05 / 2014



Thermo Scientific

# Sorvall ST 8 / 8R Centrifuge

## Instruction Manual

50143327-b • 05 / 2014



**KONFORMITÄTSERKLÄRUNG  
DECLARATION OF CONFORMITY**

Nama und Anschrift des Herstellers und des Bevollmächtigten für die Zusammenstellung der relevanten technischen Unterlagen:  
Name and address of the manufacturer and of the authorized representative to compile the relevant technical documentation:

**Thermo Electron LED GmbH  
Zweigniederlassung Osterode  
Am Kalkberg  
37520 Osterode am Harz  
Germany**

*Hierrnit erklären wir, dass die nachstehend beschriebene Maschine  
Herewith we declare, that the machinery described below*

<b>Beschreibung / description</b>	<b>: Labor-Zentrifuge / centrifuge</b>
<b>Marke / brand</b>	<b>: Sorvall</b>
<b>Modellbezeichnung / model name</b>	<b>: ST 8</b>
<b>Modell Nr. / model no.</b>	<b>: 75007201</b>
<b>Gültig ab Equipmentnr. Valid from equipment no.</b>	<b>: 720114081801</b>

*mit allen einschlägigen Bestimmungen der Richtlinie über In-vitro-Diagnostika 98/79/EG in Übereinstimmung ist  
is in conformity with all relevant terms of directive for in vitro diagnostic medical devices 98/79/EC.*

*Die Maschine ist auch in Übereinstimmung mit allen einschlägigen Bestimmungen der Richtlinie 2004/108/EG über  
elektromagnetische Verträglichkeit.  
The machinery is in accordance with all relevant terms of directives for electromagnetic compatibility 2004/108/EC.*

*Die Schutzziele nach Anhang 1 der Maschinenrichtlinie 2006/42/EG und der Niederspannungsrichtlinie 2006/95/EG werden  
eingehalten.  
The protection goals of Annex 1 for the directives machinery 2006/42/EC and low voltage 2006/95/EC are met.*

*Der oben beschriebene Gegenstand der Erklärung erfüllt auch die Vorschriften der Richtlinie 2011/65/EU  
des Europäischen Parlaments und des Rates vom 8. Juni 2011 zur Beschränkung der Verwendung  
bestimmter gefährlicher Stoffe in Elektro- und Elektronikgeräten. Die alleinige Verantwortung für die Ausstellung dieser  
Konformitätserklärung trägt der Hersteller.  
The object of the declaration described above is also in conformity with Directive 2011/65/EU  
of the European Parliament and of the Council of 8 June 2011 on the restriction of the use  
of certain hazardous substances in electrical and electronic equipment.  
This declaration of conformity is issued under the sole responsibility of the manufacturer*

Angewandte harmonisierte Normen/  
Harmonized standards used:

- EN 61010-1: 2004
- EN 61010-2-020: 2006
- EN 61010-2-101: 2002
- EN 61326-1: 2006

Osterode am Harz, den 03.09.2014

Dr. Andreas Karl  
Director R&D

	Name	Datum	Dokument	Revisions
Erstellt	Weber	03.09.2014	62141043_1	01
Freigegeben	Lehmann	03.09.2014		

**KONFORMITÄTSERKLÄRUNG  
DECLARATION OF CONFORMITY**

Name und Anschrift des Herstellers und des Bevollmächtigten für die Zusammenstellung der relevanten technischen Unterlagen:  
Name and address of the manufacturer and of the authorized representative to compile the relevant technical documentation:

**Thermo Electron LED GmbH**  
Zweigniederlassung Osterode  
Am Kalkberg  
37520 Osterode am Harz  
Germany

*Hiermit erklären wir, dass die nachstehend beschriebene Maschine  
Herewith we declare, that the machinery described below*

Beschreibung / description	: Labor- Zentrifuge mit Zubehör / centrifuge with accessories
Marke / brand	: Sorvall
Modellbezeichnung / model name	: ST 8R
Modell Nr. / model no.	: 75007204
Gültig ab Equipmentnr. Valid from equipment no.	: 41636211

mit allen einschlägigen Bestimmungen der Richtlinie über In-vitro-Diagnostika 98/79/EG in Übereinstimmung ist  
is in conformity with all relevant terms of directive for in vitro diagnostic medical devices 98/79/EC.

Die Maschine ist auch in Übereinstimmung mit allen einschlägigen Bestimmungen der Richtlinie 2004/108/EG über elektromagnetische Verträglichkeit  
The machinery is in accordance with all relevant terms of directives for electromagnetic compatibility 2004/108/EC.

Die Schutzziele nach Anhang I der Maschinenrichtlinie 2006/42/EG und der Niederspannungsrichtlinie 2006/95/EG werden eingehalten.  
The protection goals of Annex I for the directives machinery 2006/42/EC and low voltage 2006/95/EC are met.

Der oben beschriebene Gegenstand der Erklärung erfüllt auch die Vorschriften der Richtlinie 2011/65/EU des Europäischen Parlaments und des Rates vom 8. Juni 2011 zur Beschränkung der Verwendung bestimmter gefährlicher Stoffe in Elektro- und Elektronikgeräten. Die alleinige Verantwortung für die Ausstellung dieser Konformitätserklärung trägt der Hersteller.  
The object of the declaration described above is also in conformity with Directive 2011/65/EU of the European Parliament and of the Council of 8 June 2011 on the restriction of the use of certain hazardous substances in electrical and electronic equipment.  
This declaration of conformity is issued under the sole responsibility of the manufacturer.

Angewandte harmonisierte Normen:  
Harmonized standards used:

- EN 61010-1: 2004
- EN 61010-2-020: 2006
- EN 61010-2-101: 2002
- EN 61326-1: 2006

Osterode am Harz, den 10.04.2014



Dr. Andreas Karl  
Director R&D

	Name	Datum	Dokument	Rev. level
Erstellt	Demmerlein	10.04.2014	NI1440/E	00
Freigegeben	Laubach	10.04.2014		

# WEEE Compliance

This product is required to comply with the European Union's Waste Electrical & Electronic Equipment (WEEE) Directive 2002/96/EC. It is marked with the following symbol:

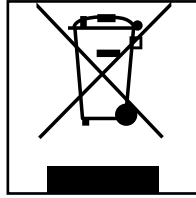

# Table of Contents

<b>WEEE Compliance</b> .....	<b>4</b>
<b>Preface</b> .....	<b>7</b>
<b>Items Supplied</b> .....	<b>7</b>
<b>Intended Use</b> .....	<b>7</b>
<b>Precautions</b> .....	<b>8</b>
Preparation.....	8
Hazardous Substances .....	9
Operating .....	9
Maintenance.....	9
<b>Symbols used on the centrifuge</b> .....	<b>10</b>
<b>Symbols used in the manual</b> .....	<b>10</b>
<b>Technical Specifications</b> .....	<b>11</b>
<b>Technical Data</b> .....	<b>11</b>
Sorvall ST 8 .....	11
Sorvall ST 8R .....	12
<b>Directives, Standards and Guidelines</b> .....	<b>13</b>
<b>Mains Supply</b> .....	<b>14</b>
<b>Rotor Selection</b> .....	<b>14</b>
<b>Transport and Set Up</b> .....	<b>15</b>
<b>Before Setting Up</b> .....	<b>15</b>
<b>Location</b> .....	<b>15</b>
<b>Transporting</b> .....	<b>15</b>
<b>Leveling</b> .....	<b>16</b>
<b>Mains Connection</b> .....	<b>16</b>
<b>Storage</b> .....	<b>17</b>
<b>Shipping</b> .....	<b>17</b>
<b>Control Panel</b> .....	<b>19</b>
<b>Sorvall ST 8</b> .....	<b>19</b>
<b>Sorvall ST 8R</b> .....	<b>20</b>
<b>Operation</b> .....	<b>21</b>
<b>Switching on the Centrifuge</b> .....	<b>21</b>
<b>Open the Centrifuge Door</b> .....	<b>21</b>
<b>Close the Centrifuge Door</b> .....	<b>21</b>
<b>Rotor Installation</b> .....	<b>22</b>
<b>Acceleration / Deceleration Rates</b> .....	<b>23</b>
Pre-Selecting Speed/RCF .....	24
Running Time Pre-Selection .....	24
Continuous Operation .....	25
Preselecting the Temperature .....	25
Prewarming or Precooling the Centrifuge .....	25
<b>Programs</b> .....	<b>26</b>

Saving a Program . . . . .	.26
Selecting a Program . . . . .	.26
<b>Centrifugation . . . . .</b>	<b>.26</b>
Maximum Loading . . . . .	.26
Starting the Centrifuge Run . . . . .	.27
Imbalance Indicator . . . . .	.27
Stopping the Centrifuge Run . . . . .	.28
<b>Short-term Centrifugation . . . . .</b>	<b>.28</b>
<b>Removing the Rotor . . . . .</b>	<b>.28</b>
<b>Aerosol-tight Rotors . . . . .</b>	<b>.29</b>
<b>Switch off Centrifuge . . . . .</b>	<b>.29</b>
<b>System Menu . . . . .</b>	<b>31</b>
<b>Flowchart System Menu. . . . .</b>	<b>.31</b>
<b>Maintenance and Care . . . . .</b>	<b>33</b>
<b>Cleaning Intervals. . . . .</b>	<b>.33</b>
<b>Basics . . . . .</b>	<b>.33</b>
Rotor and Accessories Inspection. . . . .	.33
<b>Cleaning . . . . .</b>	<b>.34</b>
Cleaning the Filter Mat . . . . .	.35
<b>Disinfection . . . . .</b>	<b>.35</b>
<b>Decontamination. . . . .</b>	<b>.36</b>
<b>Autoclaving . . . . .</b>	<b>.36</b>
<b>Service of Thermo Fisher Scientific. . . . .</b>	<b>.37</b>
<b>Shipping and Disposal . . . . .</b>	<b>.37</b>
<b>Troubleshooting . . . . .</b>	<b>39</b>
<b>Mechanical Emergency Door Release . . . . .</b>	<b>.39</b>
<b>Troubleshooting by Guide. . . . .</b>	<b>.40</b>
<b>When to contact Customer Service . . . . .</b>	<b>.42</b>
<b>Chemical Compatibility Chart . . . . .</b>	<b>43</b>
<b>Index . . . . .</b>	<b>49</b>





## Preface

Before starting to use the centrifuge, read through this instruction manual carefully and follow the instructions.

Failure to follow the instructions and safety information in this instruction manual will result in the expiration of the sellers warranty.

## Items Supplied

Item	Quantity
<b>Thermo Scientific™ Sorvall™ ST 8 / 8R Centrifuge</b>	1
Power Supply Cable	1
Instruction Manual	1
CD	1

If any parts are missing, please contact the nearest Thermo Fisher Scientific representative.

## Intended Use

This centrifuge is a laboratory product used to separate substance mixtures of different densities.

This centrifuge can become an In-vitro-diagnostics device (Directive 98/79/EC), if used together with the hematocrit rotor and his accessories.

The hematocrit value is determined using the instructions written in the instruction manual of the hematocrit rotor. The instructions are based upon the reference method following DIN 58933, allowing to determinate the erythrocyte volume fraction within the blood.

This centrifuge has to be operated by trained specialists only.

## Precautions

### **WARNING**

Observe the safety instructions. Not following these instructions can cause damage.

The centrifuge is to be used for its intended use only. Improper use can cause damages, contamination, and injuries with fatal consequences.

The centrifuge should be operated by trained specialists only.

In order to ensure safe operation of the Thermo Scientific Sorvall ST 8 / 8R Centrifuge, general safety regulations must be followed. Mind the regulations in your country.

## Set Up Conditions

### **WARNING**

- Plug the centrifuge only into sockets which have been properly grounded.
- Turn off the centrifuge at the main switch. The mains plug must be freely accessible at all times.  
Press the STOP key to shut down the centrifuge.  
Pull out the power supply plug or disconnect the power supply in an emergency.
- As safety zone maintain a clear radius of at least 30 cm around the centrifuge.  
Do not place any dangerous substances within this security zone.
- Set up in a well-ventilated environment, on a horizontally levelled and rigid surface with adequate load-bearing capacity.

## Preparation

### **WARNING**

- It is the obligation of the operator to make sure, that the proper protective clothing is used. Mind the "Laboratory Biosafety Manual" of the World Health Organization (WHO) and the regulations in your country.
- Do not make any changes to the mechanical components of the rotor.
- Do not touch the electronic components of the centrifuge nor alter any electronic or mechanical components.
- Use only with rotors which have been properly installed. Follow the instructions on the Thermo Scientific™ Auto-Lock™ rotor exchange in section "[Rotor Installation](#)" on page 22.
- Do not use rotors, buckets or accessories which show any signs of removed protective coating, corrosion or cracks. Contact customer service for further advice or inspections.
- Use only with rotors which have been loaded properly.
- Never overload the rotor.
- Always balance the samples.
- Use only rotors and accessories for this centrifuge which have been approved by Thermo Fisher Scientific. Exceptions to this rule are commercially available glass or plastic centrifuge labware, provided they have been designed to fit rotor or adapter cavities and are approved for the speed or the RCF value of the rotor.
- Make sure the rotor is locked properly into place before operating the centrifuge.
- Implement measures which ensure that no one can approach the centrifuge for longer than absolutely necessary while it is running.
- If used for foodstuffs machinery, for cosmetics or pharmaceutical products, only use closed or aerosol-tight containers for centrifugation.

## Hazardous Substances

### **WARNING**

- Especially when working with corrosive samples (salt solutions, acids, bases), the accessory parts and vessel have to be cleaned thoroughly.
- Do not centrifuge explosive or flammable materials or substances.
- The centrifuge is neither inert nor protected against explosion. Never use the centrifuge in an explosion-prone environment.
- Do not centrifuge toxic or radioactive materials or any pathogenic micro-organisms without suitable safety precautions.

If centrifuging any hazardous materials mind the “Laboratory Biosafety Manual” of the World Health Organization (WHO) and any local regulations. When centrifuging microbiological samples from the Risk Group II (according to the “Laboratory Biosafety Manual” of the World Health Organization (WHO)), aerosol-tight biological seals have to be used. Look on the internet page of the World Health Organization ([www.who.int](http://www.who.int)) for the “Laboratory Biosafety Manual”.

For materials in a higher risk group, extra safety measures have to be taken.

- If toxins or pathogenic substances have contaminated the centrifuge or its parts, appropriate disinfection measures have to be taken (“[Disinfection](#)” on page 35).
- Extreme care should be taken with highly corrosive substances which can cause damage and impair the mechanical stability of the rotor. These should only be centrifuged in fully sealed tubes.
- If a hazardous situation occurs, turn off the power supply to the centrifuge and leave the area immediately.

## Operating

### **WARNING**

- Never use the centrifuge if parts of its cover panels are damaged or missing.
- Never start the centrifuge when the centrifuge door is open.
- Do not move the centrifuge while it is running.
- Do not lean on the centrifuge.
- Do not place anything on top of the centrifuge during a run.
- Never open the centrifuge door until the rotor has come to a complete stop and this has been confirmed in the display.
- The emergency door release may be used in emergencies only to recover the samples from the centrifuge, e.g. during a power failure (see section “[Mechanical Emergency Door Release](#)” on page 39).  
Do not open the centrifuge, while it is running.

In any case of severe mechanical failure, such as rotor or bucket crash, the centrifuge is not aerosol-tight.

In case of rotor failure the centrifuge can be damaged. Leave the room. Inform customer service.

## Maintenance

### **WARNING**

The centrifuge housing is not to be opened by the operator.

## Symbols used on the centrifuge



This symbol refers to general hazards.  
CAUTION means that material damage could occur.  
WARNING means that injuries or material damage or contamination could occur.



This symbol refers to biological hazards.  
Observe the information contained in the instruction manual to keep yourself and your environment safe.



This symbol refers to information on hazards, described within the manual.



This symbol demands to disconnect mains before transporting or servicing the centrifuge.



This Symbol demands to check, if the rotor is installed correct by lifting it slightly at the handle.  
See [“Rotor Installation”](#) on page 22.

## Symbols used in the manual



This symbol refers to general hazards.  
CAUTION means that material damage could occur.  
WARNING means that injuries or material damage or contamination could occur.



This symbol refers to biological hazards.  
Observe the information contained in the instruction manual to keep yourself and your environment safe.



This symbol refers to electrical hazards.



# Technical Specifications

## Technical Data

### Sorvall ST 8

Environmental Conditions	Use in interior spaces Altitudes of up to 2000 m above sea level Max. relative humidity 80% up to 31 °C; decreasing linearly to 50% relative humidity at 40 °C
Environmental Conditions during Storage and Shipping	Temperature: -10 °C to +50 °C Humidity: 15% to 85%
Permissible Ambient Temperature during Operation	+2 °C to +35 °C

Heat Dissipation <sup>1</sup>	100 V, 50 / 60 Hz	120 V, 60 Hz	230 V, 50 / 60 Hz
	0.31 kWh/h; 1060 Btu/h; 1120 kJ/h	0.31 kWh/h; 1060 Btu/h; 1120 kJ/h	0.31 kWh/h; 1060 Btu/h; 1120 kJ/h
Overvoltage Category	II		
Pollution Degree	2		
IP	20		
Running Time	99 h 59 min 50 sec, hold		
Maximum Speed $n_{max}$	16000 rpm		
Minimum Speed $n_{min}$	300 rpm		
Maximum RCF Value at $n_{max}$	24328 x g		
Noise Level at Maximum Speed <sup>1</sup>	< 58 dB (A) (measured with a TX-150 rotor); < 61 dB (A) (measured with a MicroClick 24x2 rotor)		
Maximum Kinetic Energy	8.12 kJ		

Dimensions	
Height (open door / closed door)	660 mm / 310 mm
Width	370 mm
Depth	490 mm
Weight <sup>2</sup>	35 kg

<sup>1</sup> Front Side Measurement, 1 m in front of the instrument at 1.6 m height

<sup>2</sup> Without Rotor

## Sorvall ST 8R

Environmental Conditions	Use in interior spaces Altitudes of up to 3000 m above sea level Max. relative humidity 80% up to 31 °C; decreasing linearly to 50% relative humidity at 40 °C
Environmental Conditions during Storage and Shipping	Temperature: -10 °C to +50 °C Humidity: 15% to 85%
Permissible Ambient Temperature during Operation	+2 °C to +35 °C

Heat Dissipation <sup>1</sup>	100 V, 50 / 60 Hz	120 V, 60 Hz	230 V, 50 / 60 Hz
	0.35 kWh/h; 1170 Btu/h; 1140 kJ/h	0.35 kWh/h; 1170 Btu/h; 1140 kJ/h	0.35 kWh/h; 1170 Btu/h; 1140 kJ/h
Overvoltage Category	II		
Pollution Degree	2		
IP	20		
Running Time	99 h 59 min 50 sec, hold		
Maximum Speed $n_{max}$	17850 rpm		
Minimum Speed $n_{min}$	300 rpm		
Maximum RCF Value at $n_{max}$	30279 x g		
Noise Level at Maximum Speed <sup>1</sup>	< 56 dB (A) (measured with a TX-150 rotor)		
Maximum Kinetic Energy	10.1 kJ		
Temperature Setting Range	-10 °C to +40 °C		

Dimensions	
Height (open door / closed door)	700 mm / 320 mm
Width	460 mm
Depth	670 mm
Weight <sup>2</sup>	74 kg

<sup>1</sup> Front Side Measurement, 1 m in front of the instrument at 1.6 m height

<sup>2</sup> Without Rotor

## Directives, Standards and Guidelines

Region	Directive	Standard
<b>Europe</b> 230 V, 50 / 60 Hz	2006/95/EC Low Voltage (LVD) 2006/42/EC Machinery (MD) 2004/108/EC Electromagnetic Compatibility (EMC) 98/79/EC In-vitro-Diagnostika (IVD) 2002/96/EC Waste Electrical and Electronic Equipment (WEEE) 2011/65/EC Restriction of the use of certain hazardous substances in electrical and electronic equipment (RoHS) 1907/2006 Registration, Evaluation, Authorisation, and Restriction of Chemicals including substances of very high concern, SVHC (REACH)	EN 61010-1, 2nd Edition EN 61010-2-020, 2nd Edition EN 61010-2-101, 2nd Edition EN 61326-1 Class B EN 61326-2-6 EN ISO 13485
<b>North America (USA &amp; Canada)</b> 230 V, 60 Hz 120 V, 60 Hz	FDA Device Class 1 Product code JQC: centrifuges for clinical use	CAN/CSA-C22.2 No. 61010-1-04 UL Std. No. 61010-1, 2nd Edition) CAN/CSA-C22.2 No. 61010-2-020-09-Part 2-020 IEC 61010-2-020, 2nd Edition IEC 61010-2-101, 2nd Edition EN ISO 13485
<b>Japan</b> 100 V, 50 Hz 100 V, 60 Hz <b>China</b> 230 V, 50 / 60 Hz		IEC 61010-1, 2nd Edition IEC 61010-2-020, 2nd Edition IEC 61010-2-101, 2nd Edition EN 61326-1 Class B EN 61326-2-6 EN ISO 13485

## Mains Supply

The following table contains an overview of the electrical connection data. This data is to be taken into consideration, when selecting the mains connection socket.

Unit	Sorvall ST 8			Sorvall ST 8R		
	75007202	75007200	75007201	75007205	75007203	75007204
Mains Voltage	100 V	120 V	230 V	100 V	120 V	230 V
Frequency	50 / 60 Hz	60 Hz	50 / 60 Hz	50 / 60 Hz	60 Hz	50 / 60 Hz
Rated Current	5.5 A	5 A	2 A	10 A	8 A	4 A
Power Consumption	310 W	310 W	310 W	850 W	700 W	750 W
Equipment Fuse	10 AT	10 AT	5 AT	15 AT	15 AT	15 AT
Building Fuse	15 AT	15 AT	16 AT	15 AT	15 AT	16 AT

## Rotor Selection

The Thermo Scientific Sorvall ST 8 / 8R Centrifuge is supplied without a rotor. Various rotors are available. If not stated otherwise the rotors can be used in the Thermo Scientific Sorvall ST 8 centrifuge as also in the Thermo Scientific Sorvall ST 8R centrifuge.

Part No.	Thermo Scientific Rotors
75005701	TX-150 swinging bucket rotor
75005702	TX-150 round buckets
75005703	TX-150 50mL conical buckets
75005704	TX100S clinical swinging bucket rotor with sealed carriers
75005705	TX100 clinical swinging bucket rotor with carriers
75005706	M10 microplate swinging bucket rotor
75005723	M10 buckets
75005721	M10 sealed buckets
75005600	MT12 microtube swinging bucket rotor
75005709	HIGHConic III fixed angle rotor
75003623	CLINIConic fixed angle rotor
75005715	MicroClick 24x2 microtube rotor
75005719	MicroClick 30x2 microtube rotor
75005720	8x8 PCR Strip rotor
75005733	Hematocrit rotor
75003694	8 x 50 mL Individually Sealed rotor ( <i>only usable in the Sorvall ST 8R</i> )
75005765	MicroClick 18x5 microtube rotor ( <i>only usable in the Sorvall ST 8R</i> )

For further details on rotor use and safety, additional accessories, adapters and spare parts, please refer to the rotor manual.

For more information visit our website at <http://www.thermoscientific.com/centrifuges>



# 2

## Transport and Set Up

### Before Setting Up

1. Check the centrifuge and the packaging for any shipping damage. Inform the shipping company and Thermo Fisher Scientific immediately if any damage is discovered.
2. Remove the packaging.
3. Check, if the items supplied are complete. [Ssee "Items Supplied" on page 7.](#)  
If the items supplied are incomplete, please contact Thermo Fisher Scientific.

### Location

The centrifuge is only to be operated indoors.

The set-up location must fulfill the following requirements:

- A safety zone of at least 30 cm must be maintained around the centrifuge. People and hazardous substances must be kept out of this safety zone while centrifuging.
- The supporting structure must be stable and free of resonance.
- The supporting structure must be suitable for horizontal setup of the centrifuge.
- The centrifuge is not to be exposed to heat and strong sunlight.



#### WARNING

UV rays reduce the stability of plastics.  
Do not subject the centrifuge, rotors and plastic accessories to direct sunlight.

- The set-up location must be well-ventilated at all times.

### Transporting



#### WARNING

Always lift the centrifuge from both sides. Never lift the centrifuge by its front panel, its back panel or at its door.  
Always remove the rotor before moving the centrifuge.

Due to its weight, the centrifuge should be carried by at least two people. Always lift the centrifuge at both sides.

To prevent possible injuries at least two people should lift and carry the centrifuge by holding it at the bottom from opposite sides.

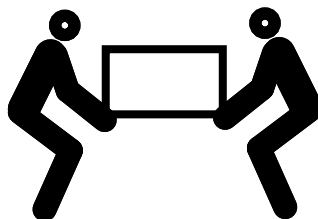

Transport the centrifuge and accessories upright within the associated packaging, if possible.

<b>NOTICE</b>
Store the original centrifuge packaging. Contact a shipping company or the customer service for the transport. Always remove the rotor before moving the centrifuge. If you do not remove the rotor you might damage the centrifuge drive or centrifuge spindle.

## Leveling

	<b>CAUTION</b>
If the centrifuge isn't leveled, imbalances can occur and the centrifuge can be damaged. Do not place anything under the centrifuge feet to level the centrifuge.	

The centrifuge is to be placed on horizontal and level supporting structures or benching.

Horizontal level is to be checked when moving the centrifuge to a new location.

## Mains Connection

<b>NOTICE</b>
Plug the centrifuge into grounded electrical sockets only.

1. Turn off the power supply switch.

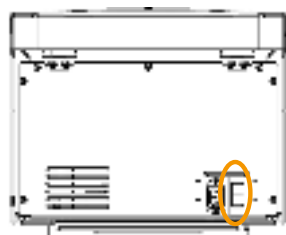

Power supply switch on the backside of the Sorvall ST 8



Power supply switch on the right side of the Sorvall ST 8R

2. Check whether the cable complies with the safety standards of your country.
3. Make sure that the voltage and frequency correspond to the figures on the rating plate.
4. Establish the connection to the power supply with the connecting cable.

## Storage



### WARNING

When removing the centrifuge and accessories from use if necessary clean, disinfect or decontaminate the entire system. In doubt contact the Thermo Fisher Scientific customer service.

- Before storing the centrifuge and the accessories, it must be cleaned and if necessary disinfected and decontaminated.  
Centrifuge, rotors, buckets and accessories have to be thoroughly dried before storage.
- Store the centrifuge in a clean, dust-free location.
- Be sure to place the centrifuge on its feet.
- Avoid direct sunlight.

## Shipping



### WARNING

Before shipping the centrifuge and accessories you have to clean and if necessary disinfect or decontaminate the entire system. In doubt contact the Thermo Fisher Scientific customer service.

Before shipping the centrifuge please bear the following in mind:

- The centrifuge must be clean and decontaminated.
- The decontamination must be confirmed in a decontamination certificate. Contact customer service for more details.



# 3

## Control Panel

The control panel contains the keys and displays of the centrifuge (only the power switch is located on the right side (Sorvall ST 8R) or on the backside (Sorvall ST 8) of the device).

### Sorvall ST 8

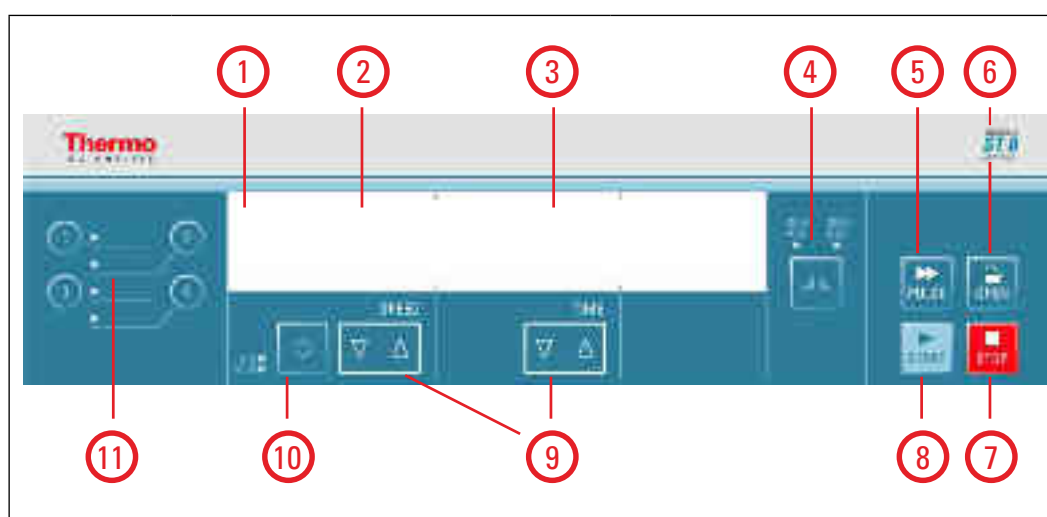

No.	Function	Display Contents
1	Status	The status of the centrifuge is displayed here.
2	Speed / RCF Value	The speed (rpm) or RCF value (x g) is displayed here.
3	Running Time	The running time is displayed here.
4	Acceleration / Deceleration Profiles	Press the key multiple times to cycle through the available profiles.
5	PULSE Key	Press the PULSE key to immediately start the centrifugation run and accelerate up to the maximal permissible end speed (depending on the used rotor). Releasing the key initiates a stopping process at the highest braking curves.
6	OPEN Key	Press the OPEN key to activate the automatic door release (possible only when device is switched on and when the rotor is fully stopped). <a href="#">"Mechanical Emergency Door Release" on page 39</a>
7	STOP Key	Press the STOP key to manually end the centrifugation run.
8	START Key	Press the START key to start a centrifugation run or to accept the current settings.
9	Arrow Keys	Use these keys in order to modify the displayed value.
10	TOGGLE Key for Speed / RCF Value	Use the TOGGLE key to change the display mode. (Speed / RCF Value).
11	Program Keys	Use the Program Keys to save and load programs. <a href="#">"" on page 25</a>

## Sorvall ST 8R

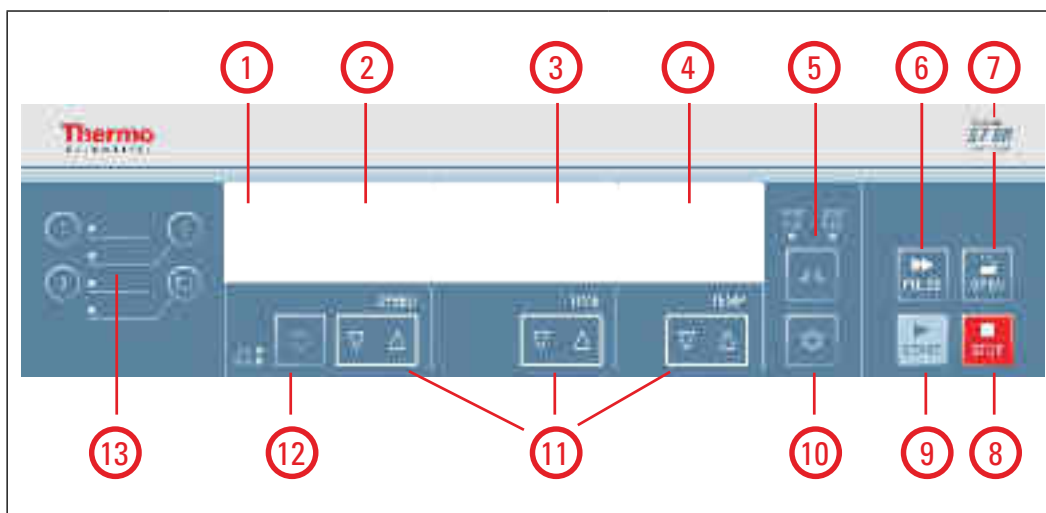

No.	Function	Display Contents
1	Status	The status of the centrifuge is displayed here.
2	Speed / RCF Value	The speed (rpm) or RCF value (x g) is displayed here.
3	Running Time	The running time is displayed here.
4	Temperature	The temperature is displayed here.
5	Acceleration / Deceleration Profiles	Press the key multiple times to cycle through the available profiles.
6	PULSE Key	Press the PULSE key to immediately start the centrifugation run and accelerate up to the maximal permissible end speed (depending on the used rotor). Releasing the key initiates a stopping process at the highest braking curves.
7	OPEN Key	Press the OPEN key to activate the automatic door release (possible only when device is switched on and when the rotor is fully stopped). <a href="#">"Mechanical Emergency Door Release" on page 39</a>
8	STOP Key	Press the STOP key to manually end the centrifugation run.
9	START Key	Press the START key to start a centrifugation run or to accept the current settings.
10	SNOWFLAKE Key	Use the key for prewarming or precooling the centrifuge.
11	Arrow Keys	Use these keys in order to modify the displayed value.
12	TOGGLE Key for Speed / RCF Value	Use the TOGGLE key to change the display mode. (Speed / RCF Value).
13	Program Keys	Use the Program Keys to save and load programs. <a href="#">"" on page 25</a>

# 4

## Operation

**NOTE** Only display pictures of the Sorvall ST 8R centrifuge are shown. The display of the Sorvall ST 8 is the same only missing the details for temperature.

### Switching on the Centrifuge

1. Turn on the power switch of the device.

The device performs a self-check of its software.

- a. When the centrifuge door is closed the display shows:

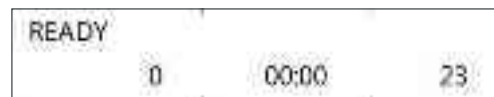

The speed and time displays read "0" and "00:00"; the current temperature inside the rotor chamber is displayed.

- b. When the centrifuge door is open the display shows:

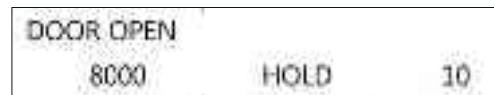

The speed and time displays show the pre-set values ; the set temperature inside the rotor chamber is displayed.

### Open the Centrifuge Door

Press the OPEN key.

### Close the Centrifuge Door

	<b>WARNING</b>
<p>Do not reach into the gap between the centrifuge door and the housing.</p> <p>Use the emergency release only for malfunctions and power failures (see "<a href="#">Mechanical Emergency Door Release</a>" on page 39).</p>	

Ensure that the centrifuge platform is clear from objects.

Keep hands and objects well clear of the underside and side of the centrifuge door when closing.

Close the centrifuge door by pressing down on it lightly in the middle or on both sides of it. The centrifuge door mechanism will click and lock in place. Lids should not be slammed as excessive force may cause damage or disrupt samples.

<b>NOTICE</b>
The centrifuge door should audibly click into place.

## Rotor Installation

The approved rotors for the Thermo Scientific Sorvall ST 8 / 8R are listed in section “Rotor Selection” on page 14. Use only the rotors from this list in the centrifuge. Permitted accessories are listed in the rotor manuals.

	<b>CAUTION</b>
Unapproved or incorrectly combined accessories can cause serious damage to the centrifuge.	

The centrifuge is equipped with an Auto-Lock-locking system.

This system is used to automatically lock the rotor to the centrifuge spindle. The rotor does not have to be bolted on to the centrifuge spindle.

Proceed as follows:

1. Open the centrifuge door and if necessary remove any dust, foreign objects or residue from the chamber.  
Auto-Lock and O-Ring must be clean and undamaged.

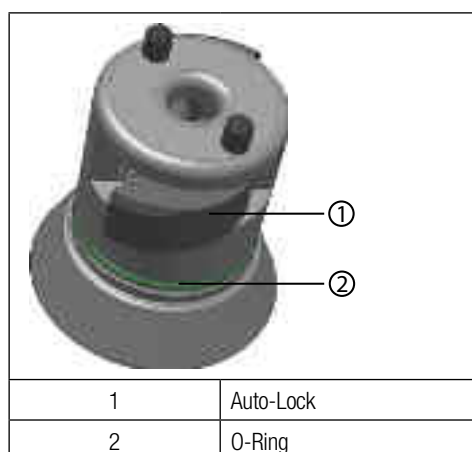

2. Place the rotor over the centrifuge spindle and lower vertically and slowly down the centrifuge spindle. If necessary a light push may be required to ensure connection.  
The rotor clicks automatically into place.



**CAUTION**

Do not force the rotor onto the centrifuge spindle.  
If the rotor is very light, then it may be necessary to press it onto the centrifuge spindle with little pressure.

3. Check if the rotor is properly installed by lifting it slightly on the handle or from beneath the rotor. If the rotor can be pulled up, then it must be reconnected to the centrifuge spindle.

**WARNING**

If the rotor cannot be properly locked in place after several attempts, then the Auto-Lock is defective and you are not permitted to operate the rotor.  
Check for any damage to the rotor and the spindle: Damaged rotors must not be used.  
Keep the centrifuge spindle area of the rotor clear of objects.  
If in doubt please call Thermo Fisher Scientific Customer Service.

**CAUTION**

Check that the rotor is properly locked on the centrifuge spindle before each use by pulling it at its handle or from beneath the rotor. The rotor has to be locked tight.

4. If available close the rotor with the rotor lid.  
Check the according rotor manual for further details on requirements and methods of closure.

**CAUTION**

Be sure to check all sealings before starting any aerosol-tight applications.  
See the information in the rotor instruction manual.

5. Close the centrifuge door.

## Acceleration / Deceleration Rates

The Thermo Scientific Sorvall ST 8 / 8R offers you 2 profiles: standard and soft. The setting is displayed above the ACCELERATION / DECELERATION key.

Press the ACCELERATION / DECELERATION key to cycle through and set the available profiles. The LEDs show the chosen settings. The last profile is saved, if you restart the centrifuge.

LED Light Settings	Description
OFF	Acceleration and Deceleration with max. Power = Standard
SOFT ACC	Acceleration = Soft
SOFT DEC	Deceleration = Soft
SOFT ACC and SOFT DEC	Acceleration and Deceleration = Soft

## Pre-Selecting Speed/RCF

RPM stands for Revolutions Per Minute.

RCF stands for Relative Centrifugal Force and allows better transfer of protocols between centrifuges and rotors of differing size.

Ensure that the rpm or RCF is correctly set.

- Press the TOGGLE key below the SPEED display to cycle through the rpm / RCF selection.  
The LED light will indicate if "RPM" or "RCF" is selected.  
RPM / RCF can be viewed during a run by pressing the toggle button.
- Enter the desired value by holding the arrow keys below SPEED in the corresponding direction, until the desired value shows. First RPM / RCF will change in steps of 10. Holding a key pressed will change the runtime then in steps of 100 and then in steps of 1000.

Press the START key to accept or wait 4 seconds until the centrifuge automatically saves the chosen values. Moving to setting time or temperature also automatically stores the set value.

### NOTICE

The minimum motor speed is 300 rpm. Any extremely low rcf settings will be automatically increased to the minimum rcf at 300 rpm.

### Explanation of RCF-Value

The relative centrifugal force (RCF) is given as a multiple of the force of gravity g. It is a unitless numerical value which is used to compare the separation or sedimentation capacity of various centrifuges, since it is independent of the type of device. Only the centrifuging radius and the speed are used for its calculation:

$$RCF = 11.18 \times \left( \frac{n}{1000} \right)^2 \times r$$

r = centrifuging radius in cm

n = rotational speed in rpm

The maximum RCF value is related to the maximum radius of the tube opening.

Remember that this value is reduced depending on the tubes and adapters used.

This can be accounted for in the calculation above if required.

## Running Time Pre-Selection

- Press the TIME arrow keys. This allows to change the set time using the arrow keys until the desired time is displayed. First runtime will change in steps of 10 second. Holding a key pressed will change the runtime by steps of single minutes, followed by steps of 10 minutes, followed by steps of single hours and at least by steps of 10 hours. This will continue until the limit of 99 hours and 59 minutes is reached.

Enter the desired runtime in hh:mm or mm:ss.



- Press the START key to accept or wait 4 seconds until the centrifuge automatically saves the chosen values. Moving to setting speed / RCF or temperature also automatically stores the set value.

## Continuous Operation

1. Press either arrow keys until HOLD is displayed.
2. Press the START key to accept or wait 4 seconds until the centrifuge automatically saves the chosen values. During continuous operation, the centrifuge will continue running until you stop it manually.

## Preselecting the Temperature

You can preselect temperatures between -10 °C and +40 °C.

To set the temperature, proceed as follows:

Press the TEMPERATURE arrow keys. This allows to change the set temperature using the arrow keys until the desired temperature is displayed. Temperature will change in steps of single degrees celsius.



The temperature cannot be adapted until the rotor has been positively identified; the speed display will then show END. When the rotor is not recognized (centrifuge door closed and START key not yet pressed, speed display "0"), the centrifuge ensures that the sample cannot freeze regardless of the rotor being used.

## Prewarming or Precooling the Centrifuge

Ensure the rotor, buckets and accessories are correctly in place and securely attached in the chamber. For setting the pretemp value for the centrifuge proceed as follows:

1. Press the SNOWFLAKE key in order to open the temperature selection menu.  
The display shows the message "Pre-Temp".
2. Enter the desired value by pressing the TEMP arrow keys, until the desired value shows.

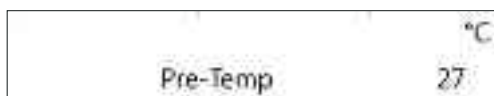

3. Press the START key.

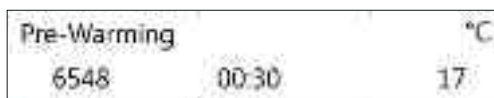

4. The centrifuge motor will start and a specific speed defined by the rotor. This improves air circulation within the chamber, resulting in improved temperature control throughout the chamber and rotor. The rotor chamber is cooled down or heated up to the preset temperature.
5. When the set temperature is reached, the centrifuge will beep and continue to hold the temperature.

Press the STOP key to end the prewarming or precooling.

The display shows the current temperature inside the rotor chamber.

## Programs

The Thermo Scientific Sorvall ST 8 Centrifuge is able to save up to 4 programs; the Thermo Scientific Sorvall ST 8R is able to save up to 99 programs. It is only possible to save a program if the centrifuge is in standstill. Loading or saving of programs is not possible if the centrifuge is spinning.

### Saving a Program

Modify the speed, time and temperature to the desired setting.

#### For Direct Access Programs 1, 2, 3

Press and hold the desired program key 1, 2 or 3 for 4 seconds.

#### For Programs 4-99

1. Press the folder key for 4 seconds. Use the SPEED arrow keys, to scroll through until the desired number is selected.
2. Press the START key to confirm.
3. The program can now be named using up to 12 alphanumeric characters. Use the SPEED arrow keys to scroll through the characters. Use the TIME arrow keys to move left or right.
4. Press the START key to confirm and save the program.

To abort at any point press the STOP key.

### Selecting a Program

#### For Direct Access Programs 1, 2, 3

Press one of the direct access program keys 1, 2, 3.

#### For Programs 4-99

Press the folder key. Use the SPEED arrow keys to scroll through until the desired program is selected.

## Centrifugation

### Maximum Loading

	<b>WARNING</b>
Injuries with fatal consequences can occur when using substance mixtures with a higher density than $1.2 \frac{g}{cm^3}$ at maximum speed .	

Rotors can run at high speeds. Each rotor is specifically designed to run at its maximum speed with a defined load. For further details refer to the rotor manual supplied with the rotor.

The rotors are designed to work with substance mixtures with a density of up to 1.2 g/ml. Above this density or if total load is above the maximum weight the following steps should be taken:

- Reduce the fill level.
- Reduce the speed.

Use the formula:

$$n_{\text{adm}} = n_{\text{max}} \sqrt{\frac{\text{Maximum permissible Load}}{\text{Effective Load}}}$$

$n_{\text{adm}}$  = admissible speed

$n_{\text{max}}$  = maximum speed

Once the rotor has been properly installed, the main switch turned on and the centrifuge door closed, you may start centrifuging.

### Use of Tubes and Consumables

Care should be taken to ensure that the tubes and bottles used in the centrifuge are:

- Rated to or above the selected rcf to be spun at
- They are being used at or above their minimum fill volume
- They are not being used above their design life (age or number of runs)
- They are inspected for damage

Refer to the manufacturers data sheets for further information.

## Starting the Centrifuge Run

Press the START key on the control panel. The centrifuge accelerates to the pre-set speed with the time display active.

If the speed setting is higher than the maximum permissible speed or RCF-value for the particular rotor, then after starting the display will show the message "Limit" – followed by the maximum RPM- or RCF-value of the inserted rotor once the centrifuge has been started.

Within 10 seconds of the error message it is possible to accept the highest RPM / RCF of the inserted rotor by pressing START. The centrifuge will then continue run for the set time and at the set temperature. If no action is taken within 10 seconds, the centrifuge will continue to decelerate. A new speed setting can be selected using the SPEED arrow keys and has to be confirmed by pressing the START key.

If no action is taken, the centrifuge will decelerate until stop, then the lid should be opened and the rotor checked.

## Imbalance Indicator

The centrifuge is fitted with an imbalance detector, to ensure safety. If an imbalance is detected at speeds higher than approx. 300 rpm an error message "Imbalance load" will be displayed.

Imbalance at high speed may indicate a tube breakage or leak or rotor crash. Therefore additional care should be taken depending on the samples loaded.

The run will terminate.

Once the run is complete, the rotor and load should be checked, ensuring that all buckets are greased and can swing free and that the tubes are balanced by following the rotor instruction manual. For information on troubleshooting, see ["Troubleshooting by Guide" on page 40](#)

## Stopping the Centrifuge Run

### With Pre-Set Running Time

If the run time is preset, the centrifuge will run at the selected speed until the desired run time is reached. It will then automatically decelerate and stop. Once stopped "RUN COMPLETED" will be displayed and if selected the display will flash. Access to the chamber and rotor can be gained by pressing the OPEN key. If selected the door will open automatically.

You can also stop the centrifuging program manually at any time by pressing the STOP key.

### Continuous Operation

If you selected continuous operation (" on page 24), you will have to stop the centrifuge manually. Press the STOP key on the control panel. The centrifuge will be decelerated at the set rate. The message "RUN COMPLETED" will be displayed. After pressing the OPEN key, the centrifuge door will open and you can remove the centrifuged samples.

## Short-term Centrifugation

For quick centrifugation, the Thermo Scientific Sorvall ST 8 / 8R has a PULSE-function.

By holding down the PULSE key, spinning will start at maximum acceleration rate, continue at maximum rotor speed until the key is released. The rotor then decelerates at maximum rate. Preset values for acceleration, deceleration and speed or RCF are disregarded for the PULSE function.

The centrifuge accelerates and brakes at maximum power. Any rpm or RCF entered beforehand is overridden.

### NOTICE

The centrifuge accelerates to maximum speed according to the rotor used.

Check carefully whether you have to maintain a certain speed for your application.

During the acceleration process, time is counted forwards in seconds. The reading stays displayed until the centrifuge door is opened.

## Removing the Rotor

To remove the rotor, proceed as follows:

1. Open the centrifuge door.
2. Grab the rotor handle and fully depress the Auto-Lock button. At the same time, pull the rotor vertically upwards and remove it from the centrifuge spindle. Make sure not to tilt the rotor while doing this.



## Aerosol-tight Rotors

For your protection when using an aerosol tight lid the rotor should only be removed with the lid closed.

### NOTICE

Rotors supplied with a lid for aerosol-tight applications come with a mandrel, which belongs to the Auto-Lock. Be sure not to place the lid onto this mandrel to prevent it from being damaged.



### CAUTION

Skin can be pierced by sharp mandrel tip.  
Do not touch the mandrel.

## Switch off Centrifuge

To turn off the centrifuge push the mains switch to "0".





# 5

## System Menu

To get into the system menu, press and hold any key on the front panel turning on the centrifuge. Keep this key depressed until system menu appears in display. Navigate through the system menu using the TIME arrow keys.

### Flowchart System Menu

The system menu can be navigated using the SPEED arrow keys. The shown entry can be changed using the TIME and TEMP arrow keys. Press the START key to save this edit and quit the system menu. Press the STOP key to quit the system menu.

Values shown at some entries in the picture below are only examples.

#### NOTICE

A total number of cycles completed on the centrifuge is counted, since installation or a new main board was installed. Cycle counts should be periodically recorded to help with the identification of the total number of runs a rotor has completed.

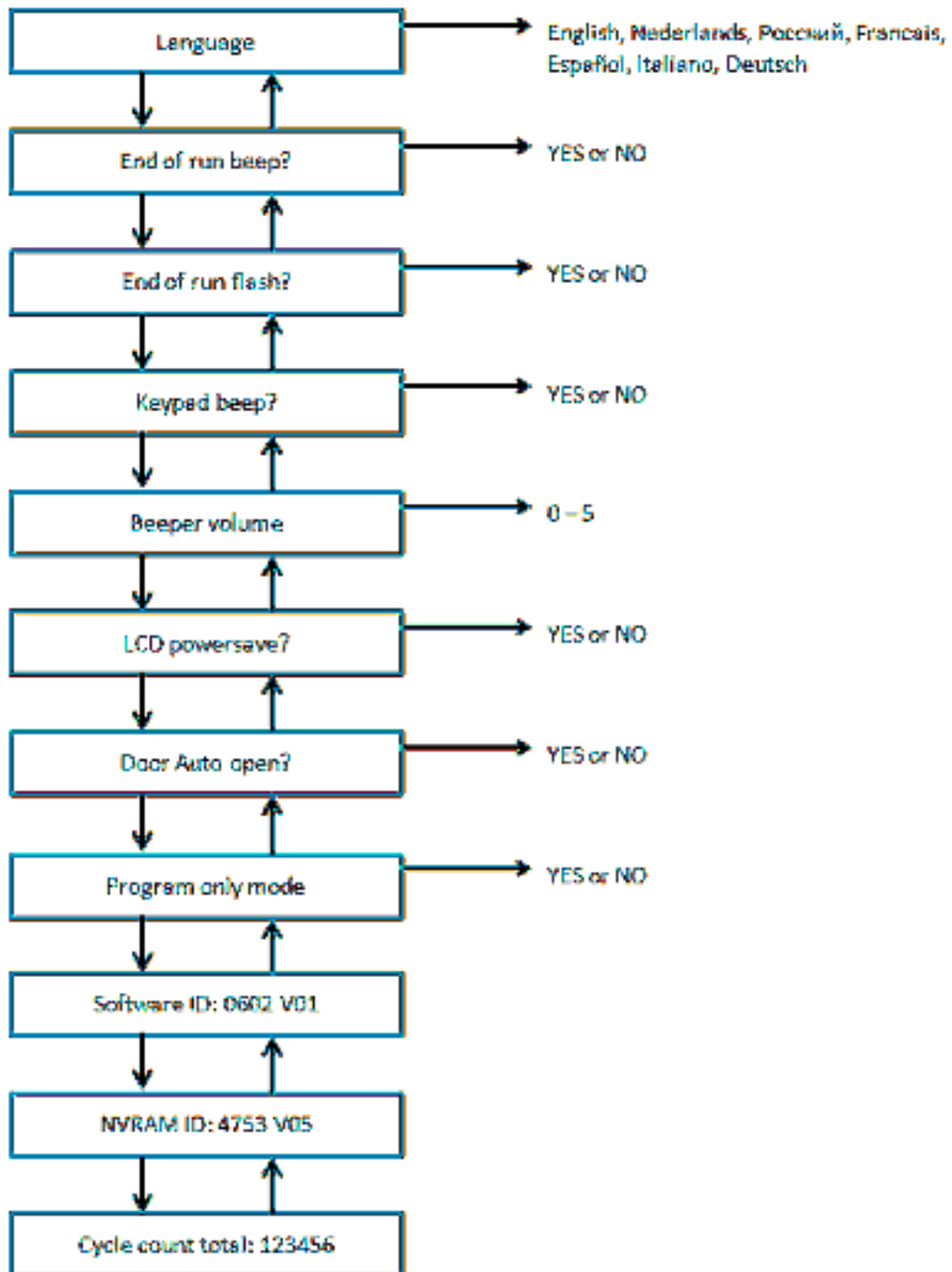

## Maintenance and Care

### Cleaning Intervals

For the sake of personal, environmental, and material protection, it is your duty to clean and if necessary disinfect the centrifuge on a regular basis.

Maintenance	Recommended Interval
Rotor Chamber (Bowl)	Daily or when polluted
Rotor	Daily or when polluted
Accessories	Daily or when polluted
Filter Mat (Capacitor)	Every six weeks or when polluted
Cabinet	Once per month
Ventilation Holes	Every six months

### Basics

	<b>CAUTION</b>
<p>Not rated procedures or agents could deteriorate the materials of the centrifuge and lead to malfunction.</p> <p>Refrain from using any other cleaning or decontamination procedure than those recommended here, if you are not entirely sure that the intended procedure is safe for the equipment.</p> <p>Use only approved cleansers.</p> <p>If in doubt, contact Thermo Fisher Scientific.</p>	

- Use warm water with a neutral detergent that is suitable for use with the materials. If in doubt contact the manufacturer of the cleaning agents.
- Never use caustic cleaning agents such as soap suds, phosphoric acid, bleaching solutions or scrubbing powder.
- Remove rotor and clean bowl with a small amount of cleaning agent, applied to a clean cloth.
- Use a soft brush without metal bristles to remove stubborn residue.  
Afterwards rinse with a small amount of distilled water and remove any excess with absorbent towels.
- Use only disinfectants with a pH of 6-8.

### Rotor and Accessories Inspection

After thoroughly cleaning rotors, they should be inspected for damage, wear and corrosion.

#### Metal Parts

Ensure that the black protective coating is complete. It can be removed through wear and chemical attack and can lead to unseen corrosions. Any signs of corrosions, such as rust or white / metallic pitting, the rotor or accessories should be immediately removed from service. Particular attention should be taken with the bottom of buckets on swing out rotors

and tube cavities on fixed angle rotors.

## Plastic Parts

Check for signs plastic crazing, fading, bruising or cracking.

	<b>CAUTION</b>
<p>Do not run any rotor or accessories with sign of damage.</p> <p>Ensure that the rotor, buckets and accessories are within the service life and number of cycles.</p> <p>It is recommend that you have rotors and accessories inspected yearly as part of your routine service to ensure safety.</p>	

## Cleaning

	<b>CAUTION</b>
<p>Before using any cleaning methods except those recommended by the manufacturer, users should check with the manufacturer of the cleaning agents that the proposed method will not damage the equipment.</p>	

Clean as follows:

1. Clean rotor, buckets and accessories outside of the centrifuge bowl.
2. Separate all rotors, buckets, lids, adapters and tubes to allow thorough cleaning.
3. Rinse rotor and all accessories with warm water and a neutral detergent that is suitable for use with the materials. If in doubt contact the manufacturer of the cleaning agents. Ensure grease on rotor trunnions (pivot point for swinging buckets) is cleaned away.
4. Use a soft brush without metal bristles to remove stubborn residue.
5. Rinse rotor and all accessories with distilled water.
6. Place the rotors on a plastic grate with their cavities pointing down, to allow to fully drain and dry.
7. Dry all of the rotors and accessories after cleaning with a cloth or in a warm air cabinet at a maximum temperature of 50 °C. If drying boxes are used, the temperature must never exceed 50 °C, since higher temperatures could damage the material and shorten the lifetime of the parts.

Once clean and dry, inspect the rotor and accessories.

After cleaning, treat the entire surface of aluminum parts including the cavities with corrosion protection oil (70009824).

Treat the bolt of the swing out rotor with bolt grease (75003786).

	<b>CAUTION</b>
<p>Drive and doo lock can be damaged by entering liquids. Do not allow liquids, especially organic solvents, to get on the drive shaft, the drive bearings or the centrifuge door locks.</p> <p>Organic solvents break down the grease in the motor bearing. The drive shaft could lock up.</p>	

## Cleaning the Filter Mat

It is recommended that you clean the filter mat (50141352) regularly every six weeks. Depending on the environmental conditions it may be necessary to clean it more often.

How to clean the filter mat:

1. Unscrew the ventilation grid placed on the right side of the centrifuge.
2. Remove the ventilation grid.
3. Remove the filter mat.
4. Clean the filter mat by tapping off the dust. The filter mat can be rinsed with water, if needed. Dry the filter mat before using it again.

**NOTE** Moisture can damage electronics and lead to additional damages at the centrifuge. Only use dry filter mats.

5. Place the filter mat back on the capacitor.
6. Screw the ventilation grid onto the centrifuge.

## Disinfection

	<b>WARNING</b>
<p>Hazardous infection is possible when touching the contaminated rotor and centrifuge parts. Infectious material can get into the centrifuge when a tube breaks or as a result of spills.</p> <p>In case of contamination, make sure that others are not put at risk.</p> <p>Disinfect the affected parts immediately.</p>	

	<b>CAUTION</b>
<p>Equipment can be damaged by inappropriate disinfection methods or agents.</p> <p>Before using any cleaning or disinfection methods except those recommended by the manufacturer, users should check with the manufacturer that the proposed method will not damage the equipment.</p> <p>Observe the safety precautions and handling instructions for the cleaning agents used.</p>	

The rotor chamber and the rotor should be treated preferably with a neutral disinfectant.

Contact the Service Department of Thermo Fisher Scientific for questions regarding the use of other disinfectants. For details check “Basics” on page 33.

Disinfect as follows:

1. Disinfect rotor, buckets and accessories outside of the centrifuge bowl.
2. Separate all rotors, buckets, lids, adapters and tubes to allow thorough disinfection.
3. Treat the rotor and accessories according to the instructions for the disinfectant. Adhere strictly to the given application times.

Be sure the disinfectant can drain off the rotor.

4. Rinse the rotor and accessories thoroughly with water and then rub down.
5. Place the rotors on a plastic grate with their cavities pointing down, to allow to fully drain and dry.

6. Dispose the disinfectant according to the applicable guidelines.
7. Clean the rotor after disinfecting as described in “Cleaning” on page 34.

## Decontamination

	<b>WARNING</b>
<p>Radiation is possible when touching the contaminated rotor and centrifuge parts. Radioactive material can get into the centrifuge when a tube breaks or as a result of spills.</p> <p>In case of contamination, make sure that others are not put at risk.</p> <p>Decontaminate the affected parts immediately.</p>	

	<b>CAUTION</b>
<p>Equipment can be damaged by inappropriate decontamination methods or agents.</p> <p>Before using any cleaning or decontamination methods except those recommended by the manufacturer, users should check with the manufacturer that the proposed method will not damage the equipment.</p> <p>Observe the safety precautions and handling instructions for the cleaning agents used.</p>	

For general radioactive decontamination use a solution of equal parts of 70% ethanol, 10% SDS (Sodium Dodecyl Sulfate) and water.

Decontaminate as follows:

1. Decontaminate rotor, buckets and accessories outside of the centrifuge bowl.
2. Separate all rotors, buckets, lids, adapters and tubes to allow thorough decontamination.
3. Treat the rotor and accessories according to the instructions for the decontamination solution. Adhere strictly to the given application times.
 

Be sure the decontamination solution can drain off the rotor.
4. Rinse the rotor first with ethanol and then with deionized water.
 

Adhere strictly to the given application times.

Be sure the decontamination solution can drain off the rotor.
5. Rinse the rotor and accessories thoroughly with water.
6. Place the rotors on a plastic grate with their cavities pointing down, to allow to fully drain and dry.
7. Dispose of the decontamination solution according to the applicable guidelines.
8. Clean the rotor after disinfecting as described in “Cleaning” on page 34.

## Autoclaving

1. Before autoclaving clean rotor and accessories as described above.
2. Place the rotor on a flat surface.
  - Rotors and adapter can be autoclaved at 121 °C.
  - The maximum permissible autoclave cycle is 20 minutes at 121 °C.

Clean the rotor before autoclaving and rinse it with distilled water. Remove all accessories (tubes, adapters) from the rotor.

Place the rotor on a flat surface.

<b>NOTE</b>
No chemical additives are permitted in the steam.

	<b>CAUTION</b>
Never exceed the permitted temperature and duration when autoclaving.	

## Service of Thermo Fisher Scientific

Thermo Fisher Scientific recommends having the centrifuge and accessories serviced once a year by an authorized service technician. The service technician checks the following

- electrical equipment
- suitability of set-up site
- centrifuge door lock and safety system
- rotor
- fixation of rotor and centrifuge spindle
- protective casing

Before service, centrifuge and rotors should be thoroughly cleaned and decontaminated to ensure full and safe inspection can be completed.

Thermo Fisher Scientific offers inspection and service contracts for this work. Any necessary repairs are performed for free during the warranty period and afterwards for a charge.

This is only valid if the centrifuge has only been maintained by an authorized Thermo Fisher Scientific service technician.

## Shipping and Disposal

	<b>WARNING</b>
When removing the centrifuge and accessories from use for disposal you have to clean and if necessary disinfect or decontaminate the entire system. In doubt contact the Thermo Fisher Scientific customer service.	

For the disposal of the centrifuge mind the regulations in your country. Contact the Thermo Fisher Scientific Customer Service for the disposal of the centrifuge. For contact information check the backpage of this manual or visit [www.thermoscientific.com/centrifuge](http://www.thermoscientific.com/centrifuge)

For the countries of the European Union the disposal is regulated by the European Union's Waste Electrical & Electronic Equipment (WEEE) Directive 2002/96/EC. ("WEEE Compliance" on page 4)

Mind the information on transport and shipping. "Transporting" on page 15 and "Shipping" on page 17





## Troubleshooting

### Mechanical Emergency Door Release

During a power failure, you will not be able to open the centrifuge door with the regular electric door release. A mechanical override is provided to allow sample recovery in the case of an emergency. This is only to be used in emergencies and after the rotor has come to a complete stop.

	<b>WARNING</b>
<p>Spinning rotor can cause serious injuries when touched. In case of power outage the rotor can still be spinning.</p> <p>Do not open the centrifuge before the rotor has stopped. Do not touch the spinning rotor. Do not brake the rotor using hands or other tools.</p>	

Always wait until the rotor has come to a stop without braking. The brake does not work when there is no current. The braking process lasts much longer than usual.

Proceed as follows:

1. Make sure the rotor has stopped (view port in the centrifuge door).
2. Pull out the power supply plug. Keep the centrifuge horizontal at all times.
3. Pull the release cord.
  - a. Sorvall ST 8

On the right side of the housing is one white plastic plug which can be removed from the plate with a small flat screwdriver. Once the plug is removed it will expose the release cord.

Pull the release cord attached to it to trigger the mechanical door release. The centrifuge door will open and the samples can be removed. Open the centrifuge door.



*Mechanical Emergency Door Release located on the right side*

b. Sorvall ST 8R

On the bottom of the housing is one white plastic plug which can be removed from the plate with a small flat screwdriver. It is located below the front side of the centrifuge. Once the plug is removed it will expose the release cord.

Pull the release cord attached to it to trigger the mechanical door release. The centrifuge door will open and the samples can be removed. Open the centrifuge door.



*Below front side*



*Mechanical Emergency Door Release on the downside*

4. Push the cord back into the centrifuge and mount the plug.

Reconnect the centrifuge once the power has been restored. Switch on the centrifuge. Press the OPEN key to have the centrifuge door locks operative again.

## Troubleshooting by Guide

If problems occur other than those listed in this table, the authorized customer service representative must be contacted.

Error number	Error message	Troubleshooting
E-002;	Read Manual	Restart the centrifuge. If the error message appears again, inform the service.
E-005;		
E-008;		
E-010;		
E-011;		
E-012;		
E-015;		
E-016;		
E-034;		
E-036;		
E-041;		
E-048;		
E-050;		
E-051;		
E-052;		
E-053;		
E-054;		
E-072;		
E-077;		
E-101;		
E-104		

Error number	Error message	Troubleshooting
E-031	Temp High!	<p>CAUTION</p> <p>Hot metal parts!</p> <p>Check, if the centrifuge is accessible.</p> <p>Be sure, that the room temperature is within the limits.</p> <p>Let the centrifuge cool down for 15 minutes.</p> <p>Be sure there is no condensed water in the rotor chamber.</p> <p>If the error message appears again, inform the service.</p>
E-017; E-020; E-021; E-022; E-023 E-078; E-079; E-080; E-081;	Read Manual	<p>Wait until the rotor has stopped.</p> <p>Check, if the rotor is qualified for the Sorvall ST 8 / 8R Centrifuge (check "Rotor Selection" on page 20).</p> <p>Check, if the bottom of the rotor is damaged and if the rotor is placed on the Auto-Lock correctly.</p> <p>If the error message appears again, inform the service.</p>
E-019	Rotor Unknown	<p>Restart the centrifuge.</p> <p>Check, if the rotor is qualified for the Sorvall ST 8 / 8R Centrifuge (check "Rotor Selection" on page 20).</p> <p>If the error message appears again, inform the service.</p>
E-025; E-027	Read Manual	<p>Check, if the centrifuge door is blocked.</p> <p>Restart the centrifuge.</p> <p>If the error message appears again, inform the service.</p>
E-029; E-045	Read Manual	<p>Check, if a rotor is installed.</p> <p>Check, if the rotor is qualified for the Sorvall ST 8 / 8R (check "Rotor Selection" on page 14).</p> <p>Restart the centrifuge.</p> <p>If the error message appears again, inform the service.</p>
E-030	Power Failure	<p>Check the power supply of the centrifuge. Make sure not to operate too many devices at one power source.</p> <p>Let the centrifuge cool down for 15 minutes.</p> <p>If the error message appears again, inform the service.</p>
E-098	Imbalance Load	<p>Check the load placed in the rotor.</p> <p>Check that the rotor cross bolts are greased well.</p> <p>Restart the centrifuge.</p> <p>If the error message appears again, inform the service.</p>

Error number	Error message	Troubleshooting
E-060	Temp Low!	CAUTION Icy metal parts! Restart the centrifuge. If the error message appears again, inform the service.
E-046	Door Open!	Restart the centrifuge. If the error message appears again, inform the service.
E-099	Set Speed Too High	The installed rotor is not rated for the programmed speed. Check the programmed speed.

## When to contact Customer Service

If you need to contact customer service, please provide the order no. and the serial no. of your centrifuge. This information can be found on the nameplate at the back near the inlet for the power supply cable.

In addition the customer service also needs the Software ID and the NVRAM ID. Both are available in the system menu.



# Chemical Compatibility Chart

CHEMICAL	MATERIAL	ALUMINUM	ANODIC COATING for ALUMINUM	BUNA N	CELLULOSE ACETATE BUTYRATE	POLYURETHANE ROTOR PAINT	COMPOSITE Carbon Fiber/Epoxy	DELFRIN™	ETHYLENE PROPYLENE	GLASS	NEOPRENE	NORLY™	NYLON	PET, POLYCLEAR™, CLEAR CRIMP™	POLYALLUMER	POLYCARBONATE	POLYESTER, GLASS THERMOSET	POLYETHERIDE	POLYETHYLENE	POLYPROPYLENE	POLYSULFONE	POLYVINYL CHLORIDE	FULON A™, TEFLON™	SILICONE RUBBER	STAINLESS STEEL	TITANIUM	TYGON™	VITON™
2-mercaptoethanol		S	S	U	/	S	M	S	/	S	U	S	S	U	S	S	/	S	S	S	S	U	S	S	S	S	S	
Acetaldehyde		S	/	U	U	/	/	/	M	/	U	/	/	/	M	U	U	U	M	M	/	M	S	U	/	S	/	U
Acetone		M	S	U	U	S	U	M	S	S	U	U	S	U	S	U	U	U	S	S	U	U	S	M	M	S	U	U
Acetonitrile		S	S	U	/	S	M	S	/	S	S	U	S	U	M	U	U	/	S	M	U	U	S	S	S	S	U	U
Alconox™		U	U	S	/	S	S	S	/	S	S	S	S	S	M	S	S	S	S	S	S	S	S	S	S	S	S	U
Allyl Alcohol		/	/	/	U	/	/	S	/	/	/	/	S	/	S	S	M	S	S	S	/	M	S	/	/	S	/	/
Aluminum Chloride		U	U	S	S	S	S	U	S	S	S	S	M	S	S	S	S	/	S	S	S	S	S	M	U	U	S	S
Formic Acid (100%)		/	S	M	U	/	/	U	/	/	/	/	U	/	S	M	U	U	S	S	/	U	S	/	U	S	/	U
Ammonium Acetate		S	S	U	/	S	S	S	/	S	S	S	S	S	S	S	U	/	S	S	S	S	S	S	S	S	S	S
Ammonium Carbonate		M	S	U	S	S	S	S	S	S	S	S	S	S	S	U	U	/	S	S	S	S	S	M	S	S	S	S
Ammonium Hydroxide (10%)		U	U	S	U	S	S	M	S	S	S	S	S	/	S	U	M	S	S	S	S	S	S	S	S	S	M	S
Ammonium Hydroxide (28%)		U	U	S	U	S	U	M	S	S	S	S	S	U	S	U	M	S	S	S	S	S	S	S	S	S	M	S
Ammonium Hydroxide (conc.)		U	U	U	U	S	U	M	S	/	S	/	S	U	S	U	U	S	S	S	/	M	S	S	S	S	/	U
Ammonium Phosphate		U	/	S	/	S	S	S	S	S	S	S	/	S	S	M	/	S	S	S	S	S	S	M	S	S	S	S
Ammonium Sulfate		U	M	S	/	S	S	U	S	S	S	S	S	S	S	S	S	/	S	S	S	S	S	U	S	S	U	U
Amyl Alcohol		S	/	M	U	/	/	S	S	/	M	/	S	/	M	S	S	S	S	M	/	/	/	U	/	S	/	M
Aniline		S	S	U	U	S	U	S	M	S	U	U	U	U	U	U	U	/	S	M	U	U	S	S	S	S	U	S
Sodium Hydroxide (<1%)		U	/	M	S	S	S	/	/	S	M	S	S	/	S	M	M	S	S	S	S	S	M	S	S	/	U	
Sodium Hydroxide (10%)		U	/	M	U	/	/	U	/	M	M	S	S	U	S	U	U	S	S	S	S	S	M	S	S	/	U	
Barium Salts		M	U	S	/	S	S	S	S	S	S	S	S	S	S	S	M	/	S	S	S	S	S	M	S	S	S	S
Benzene		S	S	U	U	S	U	M	U	S	U	U	S	U	U	U	M	U	M	U	U	U	S	U	U	S	U	S
Benzyl Alcohol		S	/	U	U	/	/	M	M	/	M	/	S	U	U	U	U	U	U	U	/	M	S	M	/	S	/	S
Boric Acid		U	S	S	M	S	S	U	S	S	S	S	S	S	S	S	S	U	S	S	S	S	S	S	S	S	S	S
Cesium Acetate		M	/	S	/	S	S	S	/	S	S	S	S	/	S	S	/	/	S	S	S	S	S	M	S	S	S	S
Cesium Bromide		M	S	S	/	S	S	S	/	S	S	S	S	S	S	S	/	/	S	S	S	S	S	M	S	S	S	S

CHEMICAL	MATERIAL	ALUMINUM	ANODIC COATING for ALUMINUM	BUNAN	CELLULOSE ACETATE BUTYRATE	POLYURETHANE ROTOR PAINT	COMPOSITE Carbon Fiber/Epoxy	DELTRIN™	ETHYLENE PROPYLENE	GLASS	NEOPRENE	NORYL™	NYLON	PET, POLYCLEAR™, CLEAR CRIMP™	POLYALLOMER	POLYCARBONATE	POLYESTER, GLASS THERMOSET	POLYETHERIMIDE	POLYETHYLENE	POLYPROPYLENE	POLYSULFONE	POLYVINYL CHLORIDE	RULON A™, TEFLON™	SILICONE RUBBER	STAINLESS STEEL	TITANIUM	TYGON™	VITON™
Cesium Chloride		M	S	S	U	S	S	S	/	S	S	S	S	S	S	S	/	/	S	S	S	S	S	S	M	S	S	S
Cesium Formate		M	S	S	/	S	S	S	/	S	S	S	S	S	S	S	/	/	S	S	S	S	S	S	M	S	S	S
Cesium Iodide		M	S	S	/	S	S	S	/	S	S	S	S	S	S	S	/	/	S	S	S	S	S	S	M	S	S	S
Cesium Sulfate		M	S	S	/	S	S	S	/	S	S	S	S	S	S	S	/	/	S	S	S	S	S	S	M	S	S	S
Chloroform		U	U	U	U	S	S	M	U	S	U	U	M	U	M	U	U	U	M	M	U	U	S	U	U	U	M	S
Chromic Acid (10%)		U	/	U	U	S	U	U	/	S	S	S	U	S	S	M	U	M	S	S	U	M	S	M	U	S	S	S
Chromic Acid (50%)		U	/	U	U	/	U	U	/	/	/	S	U	U	S	M	U	M	S	S	U	M	S	/	U	M	/	S
Cresol Mixture		S	S	U	/	/	/	S	/	S	U	U	U	U	U	U	/	/	U	U	/	U	S	S	S	S	U	S
Cyclohexane		S	S	S	/	S	S	S	U	S	U	S	S	U	U	U	M	S	M	U	M	M	S	U	M	M	U	S
Deoxycholate		S	S	S	/	S	S	S	/	S	S	S	S	S	S	S	/	/	S	S	S	S	S	S	S	S	S	S
Distilled Water		S	S	S	S	S	S	S	S	S	S	S	S	S	S	S	S	S	S	S	S	S	S	S	S	S	S	S
Dextran		M	S	S	S	S	S	S	/	S	S	S	S	S	S	S	S	S	S	S	S	S	S	S	M	S	S	S
Diethyl Ether		S	S	U	U	S	S	S	U	S	U	U	S	U	U	U	U	U	U	U	U	U	S	S	S	S	M	U
Diethyl Ketone		S	/	U	U	/	/	M	/	S	U	/	S	/	M	U	U	U	M	M	/	U	S	/	/	S	U	U
Diethylpyro-carbonate		S	S	U	/	S	S	S	/	S	S	U	S	U	S	U	/	/	S	S	S	M	S	S	S	S	S	S
Dimethylsulfoxide		S	S	U	U	S	S	S	/	S	U	S	S	U	S	U	U	/	S	S	U	U	S	S	S	S	U	U
Dioxane		M	S	U	U	S	S	M	M	S	U	U	S	U	M	U	U	/	M	M	M	U	S	S	S	S	U	U
Ferric Chloride		U	U	S	/	/	/	M	S	/	M	/	S	/	S	/	/	/	S	S	/	/	/	M	U	S	/	S
Acetic Acid (Glacial)		S	S	U	U	S	S	U	M	S	U	S	U	U	U	U	U	M	S	U	M	U	S	U	U	S	/	U
Acetic Acid (5%)		S	S	M	S	S	S	M	S	S	S	S	S	M	S	S	S	S	S	S	S	M	S	S	M	S	S	M
Acetic Acid (60%)		S	S	U	U	S	S	U	/	S	M	S	U	U	M	U	S	M	S	M	S	M	S	M	U	S	M	U
Ethyl Acetate		M	M	U	U	S	S	M	M	S	S	U	S	U	M	U	U	/	S	S	U	U	S	M	M	S	U	U
Ethyl Alcohol (50%)		S	S	S	S	S	S	M	S	S	S	S	S	U	S	U	S	S	S	S	S	S	S	S	M	S	M	U
Ethyl Alcohol (95%)		S	S	S	U	S	S	M	S	S	S	S	S	U	S	U	/	S	S	S	M	S	S	S	U	S	M	U
Ethylene Dichloride		S	/	U	U	/	/	S	M	/	U	U	S	U	U	U	U	U	U	U	/	U	S	U	/	S	/	S
Ethylene Glycol		S	S	S	S	S	S	S	S	S	S	S	S	/	S	U	S	S	S	S	S	S	S	M	S	M	S	S
Ethylene Oxide Vapor		S	/	U	/	/	U	/	/	S	U	/	S	/	S	M	/	/	S	S	S	U	S	U	S	S	S	U
Ficoll-Hypaque™		M	S	S	/	S	S	S	/	S	S	S	S	/	S	S	/	S	S	S	S	S	S	S	M	S	S	S
Hydrofluoric Acid (10%)		U	U	U	M	/	/	U	/	/	U	U	S	/	S	M	U	S	S	S	S	M	S	U	U	U	/	/
Hydrofluoric Acid (50%)		U	U	U	U	/	/	U	/	/	U	U	U	U	S	U	U	U	S	S	M	M	S	U	U	U	/	M
Hydrochloric Acid (conc.)		U	U	U	U	/	U	U	M	/	U	M	U	U	M	U	U	U	/	S	/	U	S	U	U	U	/	/
Formaldehyde (40%)		M	M	M	S	S	S	S	M	S	S	S	S	M	S	S	S	U	S	S	M	S	S	M	S	M	U	U
Glutaraldehyde		S	S	S	S	/	/	S	/	S	S	S	S	S	S	S	/	/	S	S	S	/	/	S	S	S	/	/
Glycerol		M	S	S	/	S	S	S	S	S	S	S	S	S	S	S	S	/	S	S	S	S	S	S	S	S	S	S
Guanidine Hydrochloride		U	U	S	/	S	S	S	/	S	S	S	S	S	S	S	/	/	S	S	S	S	S	U	S	S	S	S
Haemo-Sol™		S	S	S	/	/	/	S	/	S	S	S	S	S	S	S	/	/	S	S	S	S	S	S	S	S	S	S

CHEMICAL	MATERIAL	ALUMINUM	ANODIC COATING for ALUMINUM	BUNAN	CELLULOSE ACETATE BUTYRATE	POLYURETHANE ROTOR PAINT	COMPOSITE Carbon Fiber/Epoxy	DELTRIN™	ETHYLENE PROPYLENE	GLASS	NEOPRENE	NORYL™	NYLON	PET, POLYCLEAR™, CLEAR CRIMP™	POLYALLOMER	POLYCARBONATE	POLYESTER, GLASS THERMOSET	POLYHERMIDE	POLYETHYLENE	POLYPROPYLENE	POLYSULFONE	POLYVINYL CHLORIDE	RULON A™, TEFLON™	SILICONE RUBBER	STAINLESS STEEL	TITANIUM	TYGON™	VITON™
Hexane		S	S	S	/	S	S	S	/	S	S	U	S	U	M	U	S	S	U	S	S	M	S	U	S	S	U	S
Isobutyl Alcohol	/	/	M	U	/	/	S	S	/	U	/	S	U	S	S	M	S	S	S	/	S	S	S	/	S	/	S	
Isopropyl Alcohol	M	M	M	U	S	S	S	S	S	U	S	S	U	S	U	M	S	S	S	S	S	S	S	M	M	M	S	
Iodoacetic Acid	S	S	M	/	S	S	S	/	S	M	S	S	M	S	S	/	M	S	S	S	S	S	M	S	S	M	M	
Potassium Bromide	U	S	S	/	S	S	S	/	S	S	S	S	S	S	S	S	S	S	S	/	S	S	S	M	S	S	S	
Potassium Carbonate	M	U	S	S	S	S	S	/	S	S	S	S	S	S	U	S	S	S	S	S	S	S	S	S	S	S	S	
Potassium Chloride	U	S	S	/	S	S	S	S	S	S	S	S	S	S	S	/	S	S	S	S	S	S	S	U	S	S	S	
Potassium Hydroxide (5%)	U	U	S	S	S	S	M	/	S	S	S	S	/	S	U	S	S	S	S	S	S	S	M	U	M	S	U	
Potassium Hydroxide (conc.)	U	U	M	U	/	/	M	/	M	S	S	/	U	M	U	U	U	S	M	/	M	U	/	U	U	/	U	
Potassium Permanganate	S	S	S	/	S	S	S	/	S	S	S	U	S	S	S	M	/	S	M	S	U	S	S	M	S	U	S	
Calcium Chloride	M	U	S	S	S	S	S	S	S	S	S	S	S	S	M	S	/	S	S	S	S	S	S	M	S	S	S	
Calcium Hypochlorite	M	/	U	/	S	M	M	S	/	M	/	S	/	S	M	S	/	S	S	S	M	S	M	U	S	/	S	
Kerosene	S	S	S	/	S	S	S	U	S	M	U	S	U	M	M	S	/	M	M	M	S	S	U	S	S	U	S	
Sodium Chloride (10%)	S	/	S	S	S	S	S	S	/	/	/	S	S	S	S	S	/	S	S	S	S	S	/	S	S	M	/	S
Sodium Chloride (sat'd)	U	/	S	U	S	S	S	/	/	/	/	S	S	S	S	S	/	S	S	/	S	/	S	S	M	/	S	
Carbon Tetrachloride	U	U	M	S	S	U	M	U	S	U	U	S	U	M	U	S	S	M	M	S	M	M	M	M	U	S	S	
Aqua Regia	U	/	U	U	/	/	U	/	/	/	/	/	U	U	U	U	U	U	U	/	/	/	/	/	S	/	M	
Solution 555 (20%)	S	S	S	/	/	/	S	/	S	S	S	S	S	S	S	/	/	S	S	S	/	S	S	S	S	S	S	
Magnesium Chloride	M	S	S	/	S	S	S	S	S	S	S	S	S	S	S	S	S	S	S	S	S	S	S	M	S	S	S	
Mercaptoacetic Acid	U	S	U	/	S	M	S	/	S	M	S	U	U	U	U	/	S	U	U	S	M	S	U	S	S	S	S	
Methyl Alcohol	S	S	S	U	S	S	M	S	S	S	S	S	U	S	U	M	S	S	S	S	S	S	S	M	S	M	U	
Methylene Chloride	U	U	U	U	M	S	S	U	S	U	U	S	U	U	U	U	U	M	U	U	U	U	S	S	M	U	U	
Methyl Ethyl Ketone	S	S	U	U	S	S	M	S	S	U	U	S	U	S	U	U	U	S	S	U	U	S	S	S	S	U	U	
Metrizamide™	M	S	S	/	S	S	S	/	S	S	S	S	/	S	S	/	/	S	S	S	S	S	S	M	S	S	S	
Lactic Acid (100%)	/	/	S	/	/	/	/	/	/	M	S	U	/	S	S	S	M	S	S	/	M	S	M	S	S	/	S	
Lactic Acid (20%)	/	/	S	S	/	/	/	/	/	M	S	M	/	S	S	S	S	S	S	S	M	S	M	S	S	/	S	
N/Butyl Alcohol	S	/	S	U	/	/	S	/	/	S	M	/	U	S	M	S	S	S	S	M	M	S	M	/	S	/	S	
N/Butyl Phthalate	S	S	U	/	S	S	S	/	S	U	U	S	U	U	U	M	/	U	U	S	U	S	M	M	S	U	S	
N, N-Dimethyl-formamide	S	S	S	U	S	M	S	/	S	S	U	S	U	S	U	U	/	S	S	U	U	S	M	S	S	S	U	
Sodium Borate	M	S	S	S	S	S	S	S	S	S	S	U	S	S	S	S	/	S	S	S	S	S	S	M	S	S	S	
Sodium Bromide	U	S	S	/	S	S	S	/	S	S	S	S	S	S	S	S	/	S	S	S	S	S	S	M	S	S	S	
Sodium Carbonate (2%)	M	U	S	S	S	S	S	S	S	S	S	S	S	S	U	S	S	S	S	S	S	S	S	S	S	S	S	

CHEMICAL	MATERIAL	ALUMINUM	ANODIC COATING for ALUMINUM	BUNAN	CELLULOSE ACETATE BUTYRATE	POLYURETHANE ROTOR PAINT	COMPOSITE Carbon Fiber/Epoxy	DELTRIN™	ETHYLENE PROPYLENE	GLASS	NEOPRENE	NORYL™	NYLON	PET, POLYCLEAR™, CLEAR CRIMP™	POLYALLOMER	POLYCARBONATE	POLYESTER, GLASS THERMOSET	POLYETHERIMIDE	POLYETHYLENE	POLYPROPYLENE	POLYSULFONE	POLYVINYL CHLORIDE	RULON A™, TEFLON™	SILICONE RUBBER	STAINLESS STEEL	TITANIUM	TYGON™	VITON™
Sodium Dodecyl Sulfate		S	S	S	/	S	S	S	/	S	S	S	S	S	S	S	/	S	S	S	S	S	S	S	S	S	S	S
Sodium Hypochlorite (5%)		U	U	M	S	S	M	U	S	S	M	S	S	S	M	S	S	S	S	M	S	S	S	M	U	S	M	S
Sodium Iodide		M	S	S	/	S	S	S	/	S	S	S	S	S	S	S	/	/	S	S	S	S	S	S	M	S	S	S
Sodium Nitrate		S	S	S	/	S	S	S	S	S	S	S	S	S	S	S	S	/	S	S	S	S	S	U	S	S	S	S
Sodium Sulfate		U	S	S	/	S	S	S	S	S	S	S	S	S	S	S	S	S	S	S	S	S	S	M	S	S	S	S
Sodium Sulfide		S	/	S	S	/	/	/	S	/	/	/	S	S	S	U	U	/	/	S	/	/	/	S	S	M	/	S
Sodium Sulfite		S	S	S	/	S	S	S	S	M	S	S	S	S	S	S	M	/	S	S	S	S	S	S	S	S	S	S
Nickel Salts		U	S	S	S	S	S	/	S	S	S	/	/	S	S	S	S	/	S	S	S	S	S	M	S	S	S	S
Oils (Petroleum)		S	S	S	/	/	/	S	U	S	S	S	S	U	U	M	S	M	U	U	S	S	S	U	S	S	S	S
Oils (Other)		S	/	S	/	/	/	S	M	S	S	S	S	U	S	S	S	S	U	S	S	S	S	/	S	S	M	S
Oleic Acid		S	/	U	S	S	S	U	U	S	U	S	S	M	S	S	S	S	S	S	S	S	S	M	U	S	M	M
Oxalic Acid		U	U	M	S	S	S	U	S	S	S	S	S	U	S	U	S	S	S	S	S	S	S	S	U	M	S	S
Perchloric Acid (10%)		U	/	U	/	S	U	U	/	S	M	M	/	/	M	U	M	S	M	M	/	M	S	U	/	S	/	S
Perchloric Acid (70%)		U	U	U	/	/	U	U	/	S	U	M	U	U	M	U	U	U	M	M	U	M	S	U	U	S	U	S
Phenol (5%)		U	S	U	/	S	M	M	/	S	U	M	U	U	S	U	M	S	M	S	U	U	S	U	M	M	M	S
Phenol (50%)		U	S	U	/	S	U	M	/	S	U	M	U	U	U	U	U	S	U	M	U	U	S	U	U	U	M	S
Phosphoric Acid (10%)		U	U	M	S	S	S	U	S	S	S	S	U	/	S	S	S	S	S	S	S	S	S	U	M	U	S	S
Phosphoric Acid (conc.)		U	U	M	M	/	/	U	S	/	M	S	U	U	M	M	S	S	S	M	S	M	S	U	M	U	/	S
Physiologic Media (Serum, Urine)		M	S	S	S	/	/	S	/	S	S	S	S	S	S	S	S	S	S	S	S	S	S	S	S	S	S	S
Picric Acid		S	S	U	/	S	M	S	S	S	M	S	U	S	S	S	U	S	S	S	S	U	S	U	M	S	M	S
Pyridine (50%)		U	S	U	U	S	U	U	/	U	S	S	U	U	M	U	U	/	U	S	M	U	S	S	U	U	U	U
Rubidium Bromide		M	S	S	/	S	S	S	/	S	S	S	S	S	S	S	/	/	S	S	S	S	S	S	M	S	S	S
Rubidium Chloride		M	S	S	/	S	S	S	/	S	S	S	S	S	S	S	/	/	S	S	S	S	S	S	M	S	S	S
Sucrose		M	S	S	/	S	S	S	S	S	S	S	S	S	S	S	S	S	S	S	S	S	S	S	S	S	S	S
Sucrose, Alkaline		M	S	S	/	S	S	S	/	S	S	S	S	S	S	U	S	S	S	S	S	S	S	M	S	S	S	S
Sulfosalicylic Acid		U	U	S	S	S	S	S	/	S	S	S	U	S	S	S	/	S	S	S	/	S	S	U	S	S	S	S
Nitric Acid (10%)		U	S	U	S	S	U	U	/	S	U	S	U	/	S	S	S	S	S	S	S	S	S	M	S	S	S	S
Nitric Acid (50%)		U	S	U	M	S	U	U	/	S	U	S	U	U	M	M	U	M	M	M	S	S	S	U	S	S	M	S
Nitric Acid (95%)		U	/	U	U	/	U	U	/	/	U	U	U	U	M	U	U	U	U	M	U	U	S	U	S	S	/	S
Hydrochloric Acid (10%)		U	U	M	S	S	S	U	/	S	S	S	U	U	S	U	S	S	S	S	S	S	S	U	M	S	S	S
Hydrochloric Acid (50%)		U	U	U	U	S	U	U	/	S	M	S	U	U	M	U	U	S	S	S	S	M	S	M	U	U	M	M
Sulfuric Acid (10%)		M	U	U	S	S	U	U	/	S	S	M	U	S	S	S	S	S	S	S	S	S	U	U	U	S	S	S
Sulfuric Acid (50%)		M	U	U	U	S	U	U	/	S	S	M	U	U	S	U	U	M	S	S	S	S	U	U	U	M	S	S
Sulfuric Acid (conc.)		M	U	U	U	/	U	U	M	/	/	M	U	U	S	U	U	U	M	S	U	M	S	U	U	U	/	S
Stearic Acid		S	/	S	/	/	/	S	M	S	S	S	S	/	S	S	S	S	S	S	S	S	S	M	M	S	S	S
Tetrahydrofuran		S	S	U	U	S	U	U	M	S	U	U	S	U	U	U	/	M	U	U	U	U	S	U	S	S	U	U



CHEMICAL	MATERIAL	ALUMINUM	ANODIC COATING for ALUMINUM	BUNAN	CELLULOSE ACETATE BUTYRATE	POLYURETHANE ROTOR PAINT	COMPOSITE Carbon Fiber/Epoxy	DELTRIN™	ETHYLENE PROPYLENE	GLASS	NEOPRENE	NORYL™	NYLON	PET, POLYCLEAR™, CLEAR CRIMP™	POLYALLOMER	POLYCARBONATE	POLYESTER, GLASS THERMOSET	POLYETHERIMIDE	POLYETHYLENE	POLYPROPYLENE	POLYSULFONE	POLYVINYL CHLORIDE	RULON A™, TEFLON™	SILICONE RUBBER	STAINLESS STEEL	TITANIUM	TYGON™	VITON™
Toluene		S	S	U	U	S	S	M	U	S	U	U	S	U	U	U	S	U	M	U	U	U	S	U	S	U	U	M
Trichloroacetic Acid		U	U	U	/	S	S	U	M	S	U	S	U	U	S	M	/	M	S	S	U	U	S	U	U	U	M	U
Trichloroethane		S	/	U	/	/	/	M	U	/	U	/	S	U	U	U	U	U	U	U	U	U	S	U	/	S	/	S
Trichloroethylene		/	/	U	U	/	/	/	U	/	U	/	S	U	U	U	U	U	U	U	U	U	S	U	/	U	/	S
Trisodium Phosphate		/	/	/	S	/	/	M	/	/	/	/	/	/	S	/	/	S	S	S	/	/	S	/	/	S	/	S
Tris Buffer (neutral pH)		U	S	S	S	S	S	S	/	S	S	S	S	S	S	S	S	S	S	S	S	S	S	S	S	S	S	S
Triton X/100™		S	S	S	/	S	S	S	/	S	S	S	S	S	S	S	S	S	S	S	S	S	S	S	S	S	S	S
Urea		S	/	U	S	S	S	S	/	/	/	/	S	S	S	M	S	S	S	S	/	S	S	S	M	S	/	S
Hydrogen Peroxide (10%)		U	U	M	S	S	U	U	/	S	S	S	U	S	S	S	M	U	S	S	S	S	S	M	S	U	S	
Hydrogen Peroxide (3%)		S	M	S	S	S	/	S	/	S	S	S	S	S	S	S	S	M	S	S	S	S	S	S	S	S	S	
Xylene		S	S	U	S	S	S	M	U	S	U	U	U	U	U	U	M	U	M	U	U	U	S	U	M	S	U	S
Zinc Chloride		U	U	S	S	S	S	U	S	S	S	S	S	S	S	S	S	S	S	S	S	S	S	S	U	S	S	S
Zinc Sulfate		U	S	S	/	S	S	S	S	S	S	S	S	S	S	S	S	S	S	S	S	S	S	S	S	S	S	S
Citric Acid (10%)		M	S	S	M	S	S	M	S	S	S	S	S	S	S	S	S	M	S	S	S	S	S	S	S	S	S	S

<sup>1</sup> Polyethyleneterephthalate

**Key**

S – Satisfactory.

M – Moderate attack, may be satisfactory for use in centrifuge depending on length of exposure, speed involved, etc.; suggest testing under actual conditions of use.

U – Unsatisfactory, not recommended.

/ – Performance unknown; suggest testing, using sample to avoid loss of valuable material.

**NOTICE**

Chemical resistance data is included only as a guide to product use. Because no organized chemical compatibility data exists for materials under the stress of centrifugation, when in doubt we recommend pretesting sample lots.



# Index

## A

Autoclaving 36

## B

Before Setting Up 15

## C

Centrifugation 26  
Characteristics 11  
Chemical Compatibility Chart 43  
Cleaning 34  
Cleaning Intervals 33  
Close the Centrifuge Door 21  
Continuous operation 24, 28  
Control Panel 19

## D

Decontamination 36  
Directives, Standards and Guidelines 13  
Disinfection 35

## E

Entering Parameters 23

## I

Imbalance 27  
Intended Use 7  
Items Supplied 7

## L

Location 15

## M

Mains Supply 14  
Maintenance and Care 33  
Maximum Loading 26  
Mechanical Emergency Door Release 39

## O

Open the Centrifuge Door 21  
Operation 21

## P

Precautions 8  
Precooling 25  
Preface 7  
Pre-Selecting Speed/RCF 24  
Preselecting the temperature 25  
Pre-set running time 28  
Prewarming 25  
Programs 25

## R

RCF-Value 24  
Removing 28  
Rotor Evaluation and Care of Your Rotor 37  
Rotor Installation 22  
Rotor Maintenance 37  
Rotor Selection 14

Running time pre-selection 24

## S

Saving Programs 26  
Service of Thermo Fisher Scientific 37  
Shipping and Depositing 37  
Short-term Centrifugation 28  
Sorvall ST 8 11  
Sorvall ST 8R 12  
Starting the Centrifuge Run 27  
Storage 17  
Switch on Centrifuge 21  
Symbols 10

## T

Technical Data 11  
Technical Specifications 11  
Temperature Adaptation during Standstill 28  
Transport and Set Up 15  
Transporting the Centrifuge 15  
Troubleshooting 39

## W

WEEE 4

Thermo Scientific Heraeus Megafuge 8

**Thermo Electron LED GmbH**

Branch Osterode  
Am Kalkberg, 37520 Osterode am Harz  
Germany

Country of Origin:

**Thermo Fisher (Suzhou) Instruments Co., Ltd.**  
No. 297 Taishan Road, New District, Suzhou, Jiangsu  
P. R. China

Thermo Scientific Heraeus Megafuge 8R

**Thermo Electron LED GmbH**

Branch Osterode  
Am Kalkberg, 37520 Osterode am Harz  
Germany

**[thermoscientific.com/centrifuge](http://thermoscientific.com/centrifuge)**

© 2014 Thermo Fisher Scientific Inc. All rights reserved.

Delrin, TEFLON, and Viton are registered trademarks of DuPont. Noryl is a registered trademark of SABIC. POLYCLEAR is a registered trademark of Hongye CO., Ltd. Hypaque is a registered trademark of Amersham Health As. RULON A and Tygon are registered trademarks of Saint-Gobain Performance Plastics. Alconox is a registered trademark of Alconox. Ficoll is a registered trademark of GE Healthcare. Haemo-Sol is a registered trademark of Haemo-Sol. Triton X-100 is a registered trademark of Sigma-Aldrich Co. LLC. Valox is a registered trademark of General Electric Co.

All other trademarks are the property of Thermo Fisher Scientific Inc. and its subsidiaries.

Specifications, terms and pricing are subject to change. Not all products are available in all countries. Please consult your local sales representative for details. Shown pictures within the manual are examples and may differ considering the set parameters and language.

**United States/Canada** +1 866 984 3766  
**Latin America** +1 866 984 3766  
**Austria** +43 1 801 40 0  
**Belgium** +32 53 73 42 41  
**France** +33 2 2803 2180  
**Germany national toll free** 0800 1 536 376  
**Germany international** +49 61 84 90 6000  
**Italy** +39 02 95059 552

**Netherlands** +31 76 579 55 55  
**Nordic/Baltic States/CIS** +358 9 329 10200  
**Russia** +7 812 703 42 15  
**Spain/Portugal** +34 93 223 09 18  
**Switzerland** +41 44 454 12 22  
**UK/Ireland** +44 870 609 9203  
**India** +91 22 6716 2200

**China** +800 810 5118 or  
+400 650 5118  
**Japan** +81 3 5826 1616  
**Other Asian Countries** +852 2885 4613  
**Australia** +61 39757 4300  
**New Zealand** +64 9 980 6700  
**Countries not listed** +49 6184 90 6000 or  
+33 2 2803 2180

**Thermo**  
SCIENTIFIC  
Part of Thermo Fisher Scientific