

Fraction Collector Frac-920 and Frac-950

Operating Instructions

Original instructions



Table of Contents

1	Introduction	3
1.1	Important user information	4
1.2	Regulatory information	5
1.3	Instrument	8
1.3.1	<i>Fraction Collector Frac-920</i>	9
1.3.2	<i>Fraction Collector Frac-950</i>	11
1.4	Control software	12
1.5	User documentation	12
2	Safety instructions	14
2.1	Safety precautions	14
2.2	Labels	19
2.3	Emergency procedures	21
2.4	Recycling information	22
2.5	Declaration of Hazardous Substances (DoHS)	23
3	Installation	25
3.1	Site requirements	25
3.2	Transport	25
3.3	Unpacking	26
3.4	Assembly	26
3.5	Connections	26
3.6	Spare parts and accessories	27
4	Operation	28
4.1	Fraction Collector Frac-920 stand alone	28
4.2	Fraction Collector Frac-920 connected to an ÄKTA instrument	37
4.3	Fraction Collector Frac-950	39
5	Maintenance	47
5.1	General	47
5.2	Cleaning	47
5.3	Changing capillaries	48
5.4	Changing waste tubing	48
6	Troubleshooting	49
6.1	Faults and actions	49
7	Reference information	51
7.1	Specifications	51
7.2	Health and Safety Declaration Form	52
7.3	Ordering information	54

1 Introduction

Purpose of the Operating Instructions

The *Operating Instructions* provide you with the instructions needed to handle Fraction Collector Frac-920 and Frac-950 in a safe way.

Prerequisites

In order to operate Fraction Collector Frac-920 and Frac-950 as is intended, the following pre-requisites must be fulfilled:

- The user should have a general understanding of how a PC and the Microsoft® Windows® operating system works. (if a computer is used)
 - The user must understand the concepts of liquid chromatography.
 - The user must read and understand the Safety Instructions in this manual.
 - Fraction Collector Frac-920 and Frac-950 and software should be installed, configured and calibrated according to these Operating Instructions.
-

About this chapter

This chapter contains important user information, a description of the intended use of Fraction Collector Frac-920 and Frac-950, regulatory information, list of associated documentation, definitions of safety notices and so on.

1 Introduction

1.1 Important user information

1.1 Important user information

Read this before operating the product



All users must read the entire *Operating Instructions* before installing, operating or maintaining the product.

Always keep the *Operating Instructions* at hand when operating the product.

Do not operate the product in any other way than described in the user documentation. If you do, you may be exposed to hazards that can lead to personal injury and you may cause damage to the equipment.

Intended use

Fraction Collector Frac-920 and Fraction Collector Frac-950 are automated fraction collectors for use in ÄKTA™ chromatography systems. Fraction Collector Frac-920 can also be used as a stand-alone unit.

Fraction Collector Frac-920 and Frac-950 are intended for research use only, and shall not be used in any clinical procedures, or for diagnostic purposes.

Safety notices

This user documentation contains WARNINGS, CAUTIONS and NOTICES concerning the safe use of the product. See definitions below.

Warnings



WARNING

WARNING indicates a hazardous situation which, if not avoided, could result in death or serious injury. It is important not to proceed until all stated conditions are met and clearly understood.

Cautions



CAUTION

CAUTION indicates a hazardous situation which, if not avoided, could result in minor or moderate injury. It is important not to proceed until all stated conditions are met and clearly understood.

Notices



NOTICE

NOTICE indicates instructions that must be followed to avoid damage to the product or other equipment.

Notes and tips

Note: *A note is used to indicate information that is important for trouble-free and optimal use of the product.*

Tip: *A tip contains useful information that can improve or optimize your procedures.*

Typographical conventions

Software items are identified in the text by ***bold italic*** text. A colon separates menu levels, thus ***File:Open*** refers to the ***Open*** command in the ***File*** menu.

Hardware items are identified in the text by **bold** text (e.g., **Power** switch).

1.2 Regulatory information

In this section

This section describes the directives and standards that are fulfilled by Fraction Collector Frac-920 and Frac-950.

Manufacturing information

The table below summarizes the required manufacturing information. For further information, see the EU Declaration of Conformity (DoC) document.

Requirement	Content
Name and address of manufacturer	GE Healthcare Bio-Sciences AB, Björkgatan 30, SE 751 84 Uppsala, Sweden

Conformity with EU Directives

This product complies with the European directives listed in the table, by fulfilling the corresponding harmonized standards.

Directive	Title
2006/42/EC	Machinery Directive (MD)
2004/108/EC	Electromagnetic Compatibility (EMC) Directive
2006/95/EC	Low Voltage Directive (LVD)

CE marking



The CE marking and the corresponding EU Declaration of Conformity is valid for the instrument when it is:

- used as a stand-alone unit, or
 - connected to other products recommended or described in the user documentation, and
 - used in the same state as it was delivered from GE Healthcare, except for alterations described in the user documentation.
-

International standards

This product fulfills the requirements of the following standards:

Standard	Description	Notes
EN/IEC 61010-1, UL 61010-1, CAN/CSA-C22.2 No. 61010-1	Safety requirements for electrical equipment for measurement, control, and laboratory use	EN standard is harmonized with EU directive 2006/95/EC
EN 61326-1	Electrical equipment for measurement, control and laboratory use - EMC requirements	EN standard is harmonized with EU directive 2004/108/EC
EN ISO 12100	Safety of machinery. General principles for design. Risk assessment and risk reduction.	EN ISO standard is harmonized with EU directive 2006/42/EC

FCC compliance

This device complies with part 15 of the FCC Rules. Operation is subject to the following two conditions: (1) This device may not cause harmful interference, and (2) this device must accept any interference received, including interference that may cause undesired operation.

Note: *The user is cautioned that any changes or modifications not expressly approved by GE Healthcare could void the user's authority to operate the equipment.*

This equipment has been tested and found to comply with the limits for a Class B digital device, pursuant to part 15 of the FCC Rules. These limits are designed to provide reasonable protection against harmful interference in a residential installation. This equipment generates, uses and can radiate radio frequency energy and, if not installed and used in accordance with the instructions, may cause harmful interference to radio communications. However, there is no guarantee that interference will not occur in a particular installation. If this equipment does cause harmful interference to radio or television reception, which can be determined by turning the equipment off and on, the user is encouraged to try to correct the interference by one or more of the following measures:

- Reorient or relocate the receiving antenna.
- Increase the separation between the equipment and receiver.
- Connect the equipment into an outlet on a circuit different from that to which the receiver is connected.
- Consult the dealer or an experienced radio/TV technician for help.

Regulatory compliance of connected equipment

Any equipment connected to Fraction Collector Frac-920 and Frac-950 should meet the safety requirements of EN 61010-1/IEC 61010-1, or relevant harmonized standards. Within the EU, connected equipment must be CE marked.

Environmental conformity

This product conforms to the following environmental requirements.

Requirement	Title
2011/65/EU	Restriction of Hazardous Substances (RoHS) Directive
2012/19/EU	Waste Electrical and Electronic Equipment (WEEE) Directive
ACPEIP	Administration on the Control of Pollution Caused by Electronic Information Products, China Restriction of Hazardous Substances (RoHS)
Regulation (EC) No 1907/2006	Registration, Evaluation, Authorization and restriction of Chemicals (REACH)

1.3 Instrument

Fraction Collector Frac-920 and Frac-950 are automated fraction collectors for use in ÄKTA chromatography systems. Fraction Collector Frac-920 can also be used as a stand-alone unit.

1.3.1 Fraction Collector Frac-920

Main parts

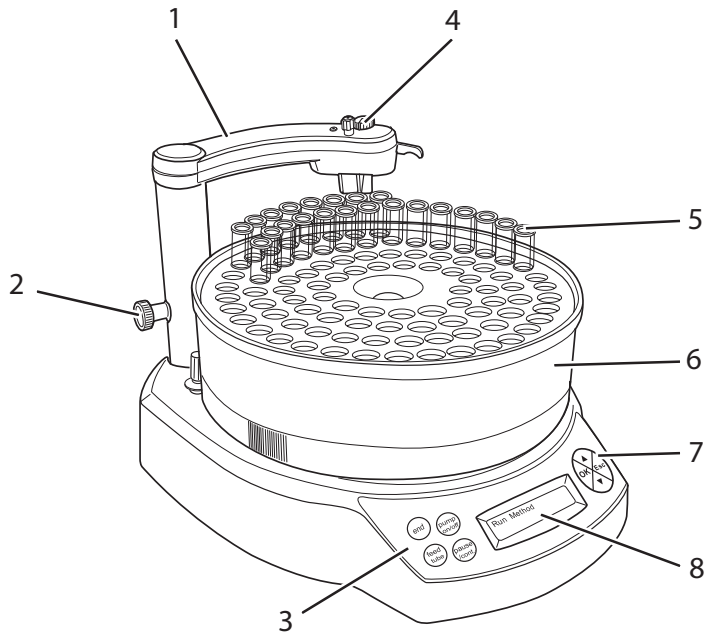
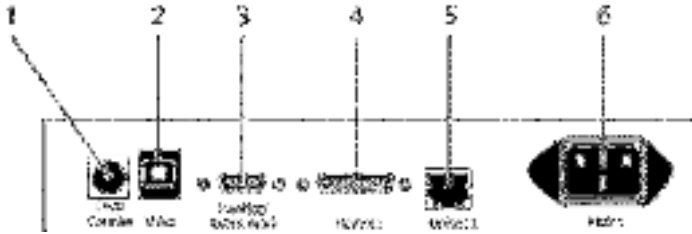

Table 1.1: The main parts of Fraction Collector Frac-920.

Part	Description
1	Delivery arm
2	Lock knob
3	Control buttons
4	Control buttons
5	Collection tubes
6	Tube rack
7	Programming buttons
8	Menu display

Electrical and communication connections



Part	Description
1	Drop sensor
2	Valve
3	Auxillary equipment
4	Remote/digital I/O
5	UniNet-1
6	Power inlet

1.3.2 Fraction Collector Frac-950

Main parts

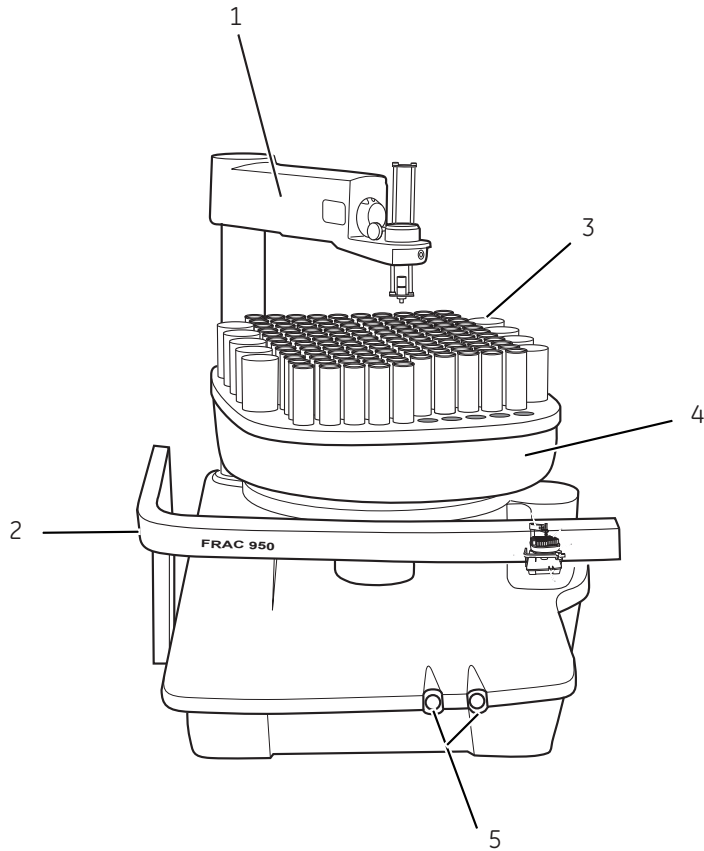
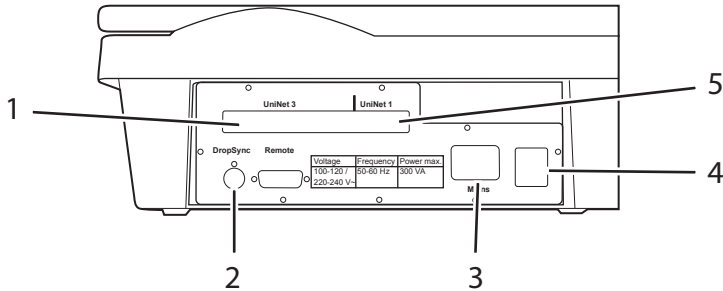

Table 1.2: The main part of Fraction Collector Frac-950

Part	Description
1	Delivery arm
2	Safety bar
3	Collection tubes
4	Tube rack
5	Indicators

Electrical and communication connections



Part	Description
1	UniNet-3 connectors
2	DropSync connector
3	Power inlet
4	Power switch
5	UniNet-1 connector

1.4 Control software

UNICORN™ control software

UNICORN is a complete software for control and supervision of Fraction Collector Frac-920 and Frac-950. The software runs under Microsoft® Windows operating system.

For more information about UNICORN control system, see the UNICORN user manuals supplied.

1.5 User documentation

In addition to these *Operating Instructions*, the documentation package supplied with Fraction Collector Frac-920 and Frac-950 also includes product documentation binders containing detailed specifications and traceability documents.

The most important documents in the document package with regard to technical aspects of Fraction Collector Frac-920 and Frac-950 are:

System-specific documentation

User documentation	Content
<i>Fraction Collector Frac-920 and Frac-950 Operating Instructions</i>	All instructions needed to operate the instrument in a safe way, including brief system description, installation, and maintenance.
<i>Fraction Collector Frac-920 and Frac-950 User Manuals</i>	Detailed system description. Comprehensive user instructions, method creation, operation, advanced maintenance and troubleshooting.
EU Declaration of Conformity for Fraction Collector Frac-920 and Frac-950	Document whereby the manufacturer ensures that the product satisfies and is in conformity with the essential requirements of the applicable directives.

Software documentation

Together with each system, the following software documentation is supplied providing additional information that applies to Fraction Collector Frac-920 and Frac-950, independent of the specific configuration:

Document	Purpose/Contents
<i>UNICORN™ manual package</i>	<ul style="list-style-type: none"> The manuals contain detailed instructions on how to administer UNICORN, work with methods, perform runs and evaluate results. The Online help contains dialog descriptions for UNICORN. The Online help is accessed from the Help menu.

Component documentation

Documentation for components produced both by GE Healthcare and by a third-party are, if existent, also included in the document package.

2 Safety instructions

About this chapter

This chapter describes safety compliance, safety labels, general safety precautions, emergency procedures, power failure and recycling of Fraction Collector Frac-920 and Frac-950.

2.1 Safety precautions

Introduction

Fraction Collector Frac-920 and Frac-950 are powered by mains voltage and handles liquids that may be hazardous. Before installing, operating or maintaining the system, you must be aware of the hazards described in this manual. Follow the instructions provided to avoid personal injury or damage to the equipment.

The safety precautions in this section are grouped into the following categories:

- General precautions
 - Using flammable liquids
 - Personal protection
 - Installing and moving the instrument
 - System operation
 - Maintenance
-

General precautions

Always follow these General precautions to avoid injury when using Fraction Collector Frac-920 and Frac-950.



WARNING

Do not operate Fraction Collector Frac-920 and Frac-950 in any other way than described in the *Fraction Collector Frac-920 and Frac-950 Operating Instructions*.



WARNING

Operation and user maintenance of the Fraction Collector Frac-920 and Frac-950 should be performed by properly trained personnel only.



WARNING

Do not use any accessories not supplied or recommended by GE Healthcare.



WARNING

Do not use the Fraction Collector Frac-920 and Frac-950 if it is not working properly, nor if it has suffered any damage, for example:

- damage to the power cord or its plug
- damage caused by dropping the equipment
- damage caused by splashing liquid onto it



WARNING

Operation and user maintenance of Fraction Collector Frac-920 and Frac-950 should be performed by properly trained personnel only.



WARNING

Do not use the Fraction Collector Frac-950 if the safety bar is broken.



CAUTION

Waste tubes and containers must be secured and sealed to prevent accidental spillage.

2 Safety instructions

2.1 Safety precautions



CAUTION

Make sure waste container is dimensioned for maximum possible volume when the equipment is left unattended.



NOTICE

Avoid condensation by letting the unit equilibrate to ambient temperature.

Using flammable liquids



WARNING

A fume hood or similar ventilation system shall be installed when flammable or noxious substances are used.

Personal protection



WARNING

Always use appropriate personal protective equipment during operation and maintenance of Fraction Collector Frac-920 and Frac-950.



WARNING

When using hazardous chemical and biological agents, take all suitable protective measures, such as wearing protective glasses and gloves resistant to the substances used. Follow local and/or national regulations for safe operation and maintenance of Fraction Collector Frac-920 and Frac-950.



WARNING

Spread of biological agents. The operator has to take all necessary actions to avoid spreading hazardous biological agents in the vicinity of the instrument. The facility should comply with the national code of practice for biosafety.

Installing and moving the instrument



WARNING

Supply voltage. Make sure that the supply voltage at the wall outlet corresponds to the marking on the equipment, before connecting the power cord.



WARNING

Fraction Collector Frac-920 and Frac-950 must always be connected to a grounded power outlet.



WARNING

Power cord. Only use power cords with approved plugs delivered or approved by GE Healthcare.



WARNING

Access to power switch and power cord with plug. Do not block access to the power switch and power cord. The power switch must always be easy to access. The power cord with plug must always be easy to disconnect.

2 Safety instructions

2.1 Safety precautions



NOTICE

Any computer used with the equipment shall comply with IEC 60950 and be installed and used according to the manufacturer's instructions.

System operation



WARNING

Hazardous chemicals during run. When using hazardous chemicals, run **System CIP** and **Column CIP** to flush the entire system tubing with distilled water, before service and maintenance.



WARNING

Hazardous biological agents during run. When using hazardous biological agents, run **System CIP** and **Column CIP** to flush the entire system tubing with bacteriostatic solution (e.g. NaOH) followed by a neutral buffer and finally distilled water, before service and maintenance.



CAUTION

Pinch hazard. Do not have any part of your body within the unit base area when Fraction Collector Frac-950 is switched on. An automatic calibration process starts when Fraction Collector Frac-950 is connected to UNICORN. During calibration, the dispenser arm moves rapidly. Several beeps are heard before the calibration procedure starts.



CAUTION

Be sure to fold down the safety bar whenever the rack holder is operated by hand. This blocks the rack holder from accidentally moving while the rack is moved by hand or replaced. (Fraction Collector Frac-950 only)

Maintenance



WARNING

Electrical shock hazard. All repairs should be done by service personnel authorized by GE Healthcare. Do not open any covers or replace parts unless specifically stated in the user documentation.



WARNING

Disconnect power. Always disconnect power from the instrument before performing any maintenance task.

2.2 Labels

In this section





This section describes the instrument labels and labels concerning hazardous substances that are attached to the Fraction Collector Frac-920 and Frac-950 instrument. For information about marking of the computer equipment, refer to the manufacturer's instructions.

Labels on the instrument

The illustration below shows an example of the identification label that is attached to Fraction Collector Frac-920 and Frac-950.



Symbols used in instrument labels

Label	Meaning
	Warning! Read the user documentation before using the equipment. Do not open any covers or replace parts unless specifically stated in the user documentation.
	The equipment complies with the requirements for electromagnetic compliance (EMC) in Australia and New Zealand.
	The equipment complies with applicable European directives.
	This symbol indicates that Fraction Collector Frac-920 and Frac-950 has been certified by a Nationally Recognized Testing Laboratory (NRTL). NRTL means an organization, which is recognized by the US Occupational Safety and Health Administration (OSHA) as meeting the legal requirements of Title 29 of the Code of Federal Regulations (29 CFR), Part 1910.7.

Labels concerning hazardous substances

Label	Meaning
	This symbol indicates that the waste of electrical and electronic equipment must not be disposed as unsorted municipal waste and must be collected separately. Please contact an authorized representative of the manufacturer for information concerning the decommissioning of equipment.

Label	Meaning
	<p>This symbol indicates that the product contains hazardous materials in excess of the limits established by the Chinese standard SJ/T11363-2006 Requirements for Concentration Limits for Certain Hazardous Substances in Electronics.</p>

2.3 Emergency procedures

In this section

This section describes how to do an emergency shutdown of the Fraction Collector Frac-920 and Frac-950 system. The section also describes the result in the event of power failure.

Emergency shutdown

In an emergency situation, do as follows to stop the run:

Step	Action
1	Press the Main power switch to the 0 position. The run is interrupted immediately.

Power failure

The result of a power failure depends on which unit that is affected.

Power failure to...	will result in...
Fraction Collector Frac-920 and Frac-950	<ul style="list-style-type: none"> The run is interrupted immediately, in an undefined state.
Computer	<ul style="list-style-type: none"> The UNICORN computer shuts down in an undefined state. The data collected up to the time of the power failure is available in UNICORN.

2.4 Recycling information

Decontamination

Fraction Collector Frac-920 and Frac-950 shall be decontaminated before decommissioning and all local regulations shall be followed with regard to scrapping of the equipment.

Disposal, general instructions

When taking Fraction Collector Frac-920 and Frac-950 out of service, the different materials must be separated and recycled according to national and local environmental regulations.

Recycling of hazardous substances

Fraction Collector Frac-920 and Frac-950 contains hazardous substances. Detailed information is available from your GE Healthcare representative.

Disposal of electrical components

Waste of electrical and electronic equipment must not be disposed as unsorted municipal waste and must be collected separately. Please contact an authorized representative of the manufacturer for information concerning the decommissioning of equipment.



2.5 Declaration of Hazardous Substances (DoHS)

根据SJ/T11364-2006《电子信息产品污染控制标识要求》特提供如下有关污染控制方面的信息。

The following product pollution control information is provided according to SJ/T11364-2006 Marking for Control of Pollution caused by Electronic Information Products.

电子信息产品污染控制标志说明

Explanation of Pollution Control Label



该标志表明本产品含有超过SJ/T11363-2006《电子信息产品中有毒有害物质的限量要求》中限量的有毒有害物质。标志中的数字为本产品的环保使用期，表明本产品在正常使用的条件下，有毒有害物质不会发生外泄或突变，用户使用本产品不会对环境造成严重污染或对其人身、财产造成严重损害的期限。单位为年。

为保证所声明的环保使用期限，应按产品手册中所规定的环境条件和方法进行正常使用，并严格遵守产品维修手册中规定的期维修和保养要求。

产品中的消耗件和某些零部件可能有其单独的环保使用期限标志，并且其环保使用期限有可能比整个产品本身的环保使用期限短。应到期按产品维修程序更换那些消耗件和零部件，以保证所声明的整个产品的环保使用期限。

本产品在使用寿命结束时不可作为普通生活垃圾处理，应被单独收集妥善处理。

This symbol indicates the product contains hazardous materials in excess of the limits established by the Chinese standard SJ/T11363-2006 Requirements for Concentration Limits for Certain Hazardous Substances in Electronic Information Products. The number in the symbol is the Environment-friendly Use Period (EFUP), which indicates the period during which the toxic or hazardous substances or elements contained in electronic information products will not leak or mutate under normal operating conditions so that the use of such electronic information products will not result in any severe environmental pollution, any bodily injury or damage to any assets. The unit of the period is "Year".

In order to maintain the declared EFUP, the product shall be operated normally according to the instructions and environmental conditions as defined in the product manual, and periodic maintenance schedules specified in Product Maintenance Procedures shall be followed strictly.

Consumables or certain parts may have their own label with an EFUP value less than the product. Periodic replacement of those consumables or parts to maintain the declared EFUP shall be done in accordance with the Product Maintenance Procedures.

This product must not be disposed of as unsorted municipal waste, and must be collected separately and handled properly after decommissioning.

2 Safety instructions

2.5 Declaration of Hazardous Substances (DoHS)

有毒有害物质或元素的名称及含量

Name and Concentration of Hazardous Substances

产品中有毒有害物质或元素的名称及含量

Table of Hazardous Substances' Name and Concentration

部件名称 Component name	有毒有害物质或元素 Hazardous substance					
	铅 Pb	汞 Hg	镉 Cd	六价铬 Cr6+	多溴联苯 PBB	多溴二苯醚 PBDE
18-1177-40	X	0	0	0	0	0
18-6083-00	X	0	0	0	0	0

- 0: 表示该有毒有害物质在该部件所有均质材料中的含量均在SJ/T11363-2006标准规定的限量要求以下
- X: 表示该有毒有害物质至少在该部件的某一均质材料中的含量超出SJ/T11363-2006标准规定的限量要求
- 此表所列数据为发布时所能获得的最佳信息
- 0: Indicates that this toxic or hazardous substance contained in all of the homogeneous materials for this part is below the limit requirement in SJ/T11363-2006.
- X: Indicates that this toxic or hazardous substance contained in at least one of the homogeneous materials used for this part is above the limit requirement in SJ/T11363-2006.
- Data listed in the table represents best information available at the time of publication.

3 Installation

Fraction Collector Frac-920 and Frac-950 is delivered in protective packing material and shall be unpacked with great care.

Any equipment connected to Fraction Collector Frac-920 and Frac-950 must fulfill applicable standards and local regulations.

For detailed information on Installation, see *Fraction Collector Frac-920 and Frac-950 User Manuals*.

3.1 Site requirements

Parameter	Requirement
Operation site	Indoor use
Altitude	Maximum 2000 m
Electrical power	100-240 V AC \pm 10%, 50-60 Hz
Transient overvoltages	Overvoltage category II
Ambient temperature	4°C to 40°C
Placement	Stable laboratory bench
Humidity	20% to 95%, non-condensing
Pollution degree	2

3.2 Transport

The equipment can be transported on a trolley capable of supporting at least 20 kg.



NOTICE

Always lift Fraction Collector Frac-920 and Frac-950 by the base unit, never by the delivery arm, as this may damage the arm.

Before moving the system:

- disconnect all cables and tubing connected to peripheral components and liquid containers.

3 Installation

3.2 Transport

- lift the instrument by the base unit.

To make it easier to move Fraction Collector Frac-950 on the laboratory bench, first lift the front (approx. 30°) and tilt the unit until the rubber feet clear the bench. Then move the unit to the desired location.

3.3 Unpacking

Check for damage

Check the equipment for damage before starting assembly and installation. There are no loose parts in the transport box. All parts are either mounted on the system or located in the accessory kit box. If any damage is found, document the damage, and contact your local GE Healthcare representative.

Unpack the system

Remove straps and packing material. Then set the equipment upright before starting installation.

3.4 Assembly

The following parts must be added to the Fraction Collector Frac-920 and Frac-950 instrument before it can be used:

- Tube rack
- Collection tubes
- Tubing
- Waste tube

3.5 Connections

Communication

Make sure that UNICORN control software is installed on the computer.

Connect the Fraction Collector Frac-920 and Frac-950 according to the electrical drawings in electrical and communication connections for Fraction Collector Frac-920 or electrical and communication connections for Fraction Collector Frac-950, respectively.

Flow path

Connect inlet and outlet tubing to the system. See *Fraction Collector Frac-920 and Frac-950 User Manuals*.

Electrical power

Connect the power cord to a grounded power outlet specified in [Section 3.1 Site requirements, on page 25](#).

3.6 Spare parts and accessories

For correct up to date information on spare parts and accessories visit:
www.gelifesciences.com/AKTA

4 Operation

About this chapter

This chapter provides instructions for the use of Fraction Collector Frac-920 and Frac-950.

4.1 Fraction Collector Frac-920 stand alone

Starting the instrument

- 1 Connect the power cord to the mains power outlet. The display lights up and the system immediately performs a self-test.

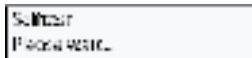

- 2 During the self-test, several messages are shown on the display, for example system name and software version number, and a beep is heard. If an error is detected during the self-test, an error message is shown.



- 3 The self-test takes about five seconds. When the start-up is completed, the display shows the **Run Method** menu.



Menu display

See Fraction Collector Frac-920 for the layout of the Frac-920 front panel.

- Press Δ or ∇ to select a specific menu.
- Press **OK** to enter a sub menu.
- Press **Esc** once to move back one menu level, or repeatedly to return to the main menu level.

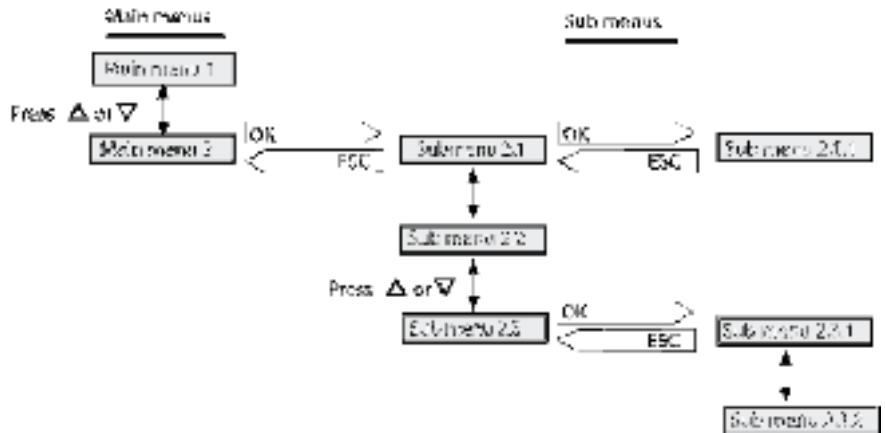

The Fraction Collector Frac-920 software is divided into three main menus:

Menu	Description
	Run Method is used for running methods that are programmed by the user. The Run Method menu is displayed after the self-test. See Running a method, on page 35 .
	Program Method is used for creating new methods. To reach the Program Method menu, press ∇ . See Programming a method, on page 31 .
	Setup and Check is used for setup and checking internal system parameters, such as Fraction Base and Delay UV to Frac. For more information, refer to Fraction collector Frac-920 User Manual. To reach the Setup and Check menu , press ∇ again.

Changing a parameter value



No.	Description
1	Parameter

4 Operation





4.1 Fraction Collector Frac-920 stand alone

No.	Description
2	Current value
3	New value to be set

To change a parameter value:

- 1 Press **OK** to enter the set value mode.
- 2 Press \blacktriangle or \blacktriangledown to change the set value. A cursor below a text or numerical value shows what is affected when pressing the buttons.
- 3 Press **OK** to verify the set value and exit the set value mode. To cancel, press **Esc**.

Control buttons

Button	Description
	Press feed tube to advance the fraction collector one position. The tube feed is delayed according to the set value in the Set Delay UV to Frac menu. The control button feed tube is disabled if connected to CAN bus. If the pump is off, the tube feed is done without a delay.
	Press end to interrupt method operation before the method is completed.
	Press pump on/off to start/stop the pump. When no method is running, the pump can be used for e.g. buffer exchange or equilibration.
	Press pause/cont. to pause all operation without ending the method. All functions, including pump and fraction collector, are stopped. Press pause/cont. again to restart the method operation.

Programming a method

Under this menu you can create up to 99 different methods. In a method you can choose e.g. fraction size, and fraction start and stop. When saving a method, it will be designated a method number.

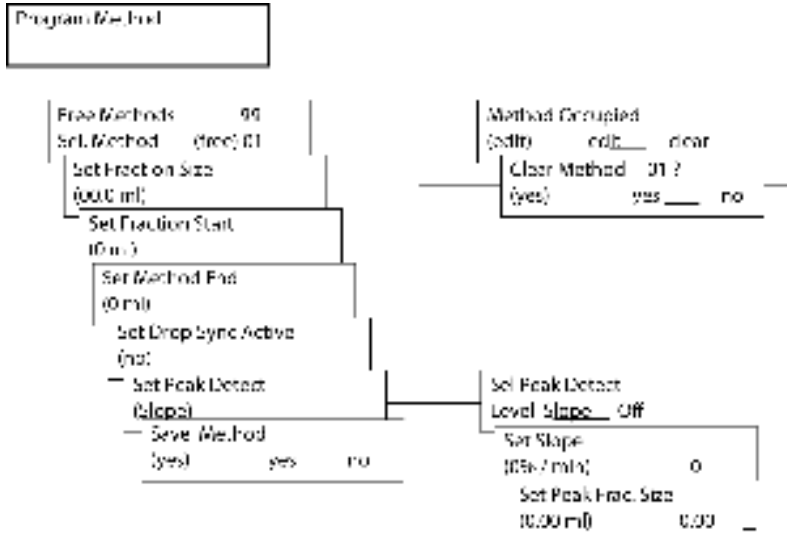

Note: Before starting to create a method the method base should be checked (for more information, refer to Fraction Collector Frac-920 User Manual).

Creating a new method

To create a new method:

- 1 From the **Run Method** menu, press ∇ to reach the **Program Method** menu.

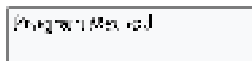

- 2 Press **OK**.
- 3 The number of free methods is displayed.



- 4 Select a free method and press **OK**.

Editing a method

To edit a method:

4 Operation

4.1 Fraction Collector Frac-920 stand alone

- 1 Select a method number to edit. Press **OK**.



```
Method Occupied
(edit) edit clear
```

- 2 Select **edit** in the **Method Occupied** menu. Press **OK**.

Note: *It is only possible to change methods that have the same method base as the one currently selected in **Setup and Check**.*

Clearing a method

To clear a method (independent of method base):

- 1 Select a method number to clear. Press **OK**.

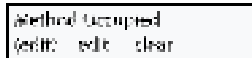

```
Method Occupied
(edit) edit clear
```

- 2 Select **clear**.

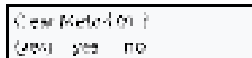

```
Clear Method ( )
(yes) yes no
```

- 3 To confirm the deletion, select **yes**. Press **OK**.

Setting fraction parameters

When a new method is created or a current is edited, the first displayed menu will be **Set Fraction Size**.

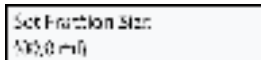

```
Set Fraction Size
100.0 m
```

- 1 Press **OK** and select a fraction size using the arrow buttons.



```
Set Fraction Size
10.0 m
```

- 2 Press **OK**.
- 3 To set fraction start, press ∇ . Press **OK**.
- 4 Set a start value.



```
Set Fraction Start
1.00
```

5 Press **OK**.

Note: *Fraction start is used if you want to have a delay between the method start and the start of collecting fractions. The pump is always started directly at method start.*

6 To set a method end, press ∇ . Press **OK**.

7 Set a method end value.

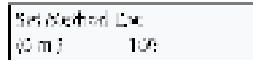

8 Press **OK**.

9 To activate the drop synchronization, press ∇ . Press **OK**.

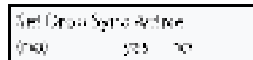

10 Select **yes**. To deactivate the function, select **no**. Press **OK**.

Note: *The flow rate should be < 5 ml/min to make drop synchronization possible.*

Setting peak detection

The peak detecting function can be set to **Off**, **Level** or **Slope**.

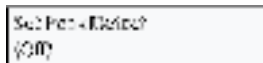

To skip peak detection, press ∇ .

1 To activate a peak detecting function. Press **OK**.

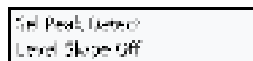

2 Select Peak Detect: **Level** or **Slope**. Press **OK**.

- If **Level** has been selected, set an absorbance level (% FSD) when to start collecting fractions.
- If **Slope** has been selected, set a slope (%/min).

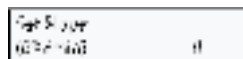

- Press **OK**.

4 Operation

4.1 Fraction Collector Frac-920 stand alone

- 3 Set peak fraction size (ml).



- 4 Press **OK**.

For more information about the peak detection parameters, refer to *Fraction Collector Frac-920 User Manual*.

Saving the method

- 1 Decide to save the method, select **yes** or **no**.



- 2 Press **OK**.
-

Running a method

Used for running methods that are programmed by the user.

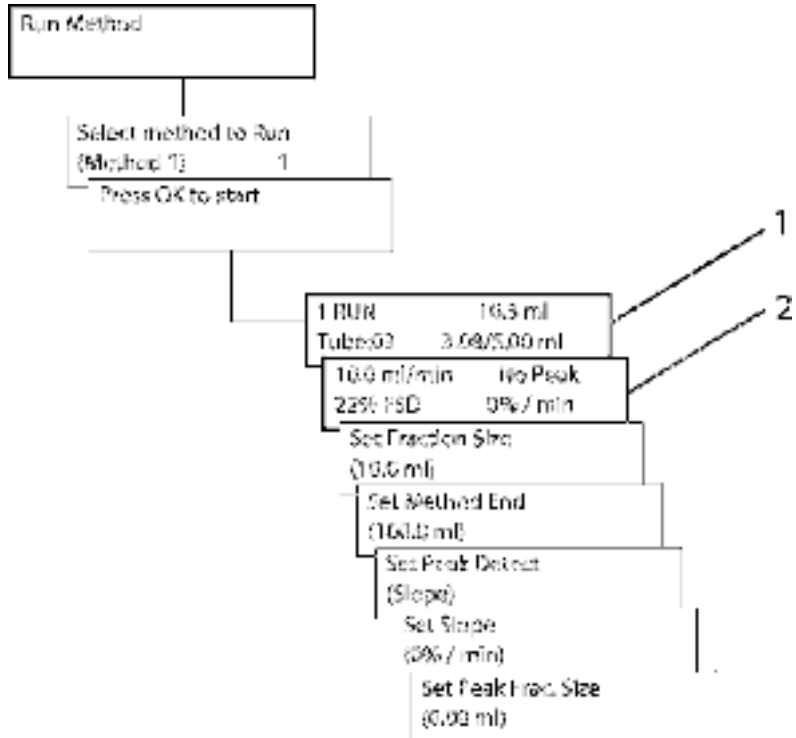

No.	Description	No.	Description
1	Run menu 1	2	Run menu 2

- 1 Use the **Esc** and arrow buttons to reach the **Run Method** menu.

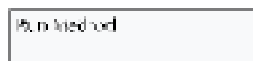

- 2 Press **OK**.
- 3 Select which method to run.

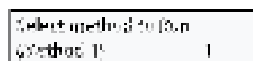

4 Operation

4.1 Fraction Collector Frac-920 stand alone

- 4 Press **OK**.



Press OK to start

- 5 Press **OK** to start the run.

The status of the run is displayed. By using the arrow buttons, different statuses are displayed.

Run menu 1

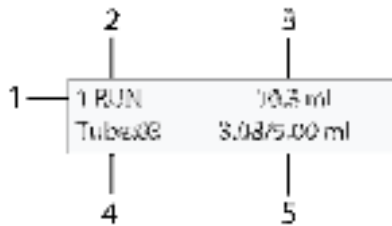

No.	Description
1	Method no.
2	Method status
3	Method run length
4	Tube no.
5	Actual tube volume/fraction or peak fraction size. Tube volume is counted from 0 to set value.

Run menu 2

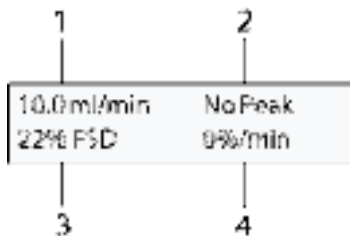

No.	Description
1	Flow (ml/min), if a valid pump is connected.

No.	Description
2	Peak indication (Peak or No peak) is shown, if peak detect is turned on (Slope or Level).
3	UV absorbance value (% FSD).
4	Slope or level value (%/min or %).

Fraction size, **Method End** and **Peak detect** can be changed during the run. To reach the menus, use the arrow button. The changes of settings are the same as for programming a method.

By setting the value of fraction size to zero, the SV-923 valve is set to waste (if connected). **Pause/cont.** can be activated. **Method End** cannot be set to a value below actual value of run method. The **pump on/off** button is not active during run.

4.2 Fraction Collector Frac-920 connected to an ÄKTA instrument

Fraction Collector Frac-920 is controlled from a PC running UNICORN version 3.0 or higher. Control of Fraction Collector Frac-920 can be achieved automatically from a prepared method, or manually via the functions available in UNICORN.

Note: *Fraction Collector Frac-920 are designated "Frac-900" in UNICORN.*

Note: *When Fraction Collector Frac-920 is controlled from UNICORN, all menu push buttons are disabled.*

The manual instructions in UNICORN allow the following operations:

- Collecting a fixed volume in each tube.
- Collecting each peak in a separate tube.
- Feed tube – move on to next tube.

It is also possible to set the delay volume, which corresponds to the volume between the UV monitor and Fraction Collector Frac-920. This value must be changed if the tubing is changed to tubing of a different inner diameter, see [Setting the delay volume, on page 39](#).

Starting the instrument

- 1 Connect the power cord to the mains power outlet. The display lights up and the system immediately performs a self-test.

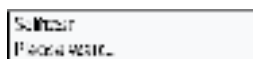

4 Operation

4.2 Fraction Collector Frac-920 connected to an ÄKTA instrument

- 2 During the self-test, several messages are shown on the display, for example system name and software version number, and a beep is heard.



Unit 920
V200

If an error is detected during the self-test, an error message is shown.

- 3 The self-test takes about five seconds. When the self-test is completed, the display shows the **Run Method** menu.



Run Method

- 4 When UNICORN connects to Fraction Collector Frac-920, the display shows the message **Uninet 1 connected** for a few seconds.

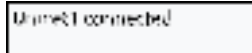

Uninet1 connected

- 5 When connection is established, the message **Setup and check** is displayed.

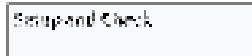

Setup and Check

Flow during tube change

The sample flow during tube change can be handled in two different ways. The selections can be found under menu **System Control: System: Settings: Specials**.

- 1 To change the settings, select the instruction **FracParameters**.
 - 2 For the parameter **TubeChange** select one of the following options:
 - **Tube** - No synchronization of collection.
 - **DropSync** - Tube change synchronized to drop release to minimise spillage. Should only be used at flow rates below 5 ml/min.
 - 3 Click on the **Execute** or **OK** button.
-

Setting the delay volume

The delay volume between the UV monitor and Fraction Collector Frac-920 in your ÄKTA chromatography system can be set. The fraction marks shown in UNICORN will be adjusted according to this volume to show the actual parts collected.

- 1 Select menu **System Control: System: Settings: Specials** in UNICORN.
- 2 To change the settings, select the instruction **FracParameters**.
- 3 Enter the new delay volume value. The appropriate value for your particular system is found in the *Reference information*, a chapter in the System Manual of your ÄKTA chromatography system. Refer also to the *ÄKTA design Optional Configuration User Manual*.
- 4 Click on the **OK** button. The value entered will be used until a further change is made.

4.3 Fraction Collector Frac-950



CAUTION

Pinch hazard. Do not have any part of your body within the unit base area when Fraction Collector Frac-950 is switched on. An automatic calibration process starts when Fraction Collector Frac-950 is connected to UNICORN. During calibration, the dispenser arm moves rapidly. Several beeps are heard before the calibration procedure starts.



CAUTION

Be sure to fold down the safety bar whenever the rack holder is operated by hand. This blocks the rack holder from accidentally moving while the rack is moved by hand or replaced. (Fraction Collector Frac-950 only)



NOTICE

The DropSync unit will be damaged if it is positioned below the tube rims.

Turn on the Fraction Collector Frac-950 using the Power switch at the rear panel. The Fraction Collector Frac-950 now performs a self-test.

There is one green and one yellow indicator on the front of Fraction Collector Frac-950.

4 Operation

4.3 Fraction Collector Frac-950

The green indicator shows:

- when flashing — power is on
- when continuously lit — power is on and connection with UNICORN is established.

When lit, the yellow indicator shows that Fraction Collector Frac-950 is running.

When connected to UNICORN, several beeps are heard after which Fraction Collector Frac-950 starts to perform an automatic calibration process. During this process, the tube holder moves rapidly in several directions. When calibration is completed, the tube holder stops in the home position.

Note: *The safety bar must be folded up for Fraction Collector Frac-950 to start up.*

Operating Fraction Collector Frac-950

Fraction Collector Frac-950 is controlled from a PC running UNICORN version 3.21 or higher for standard mode or version 4.0 or higher for prep mode. For ÄKTAmicro, UNICORN version 5.0 or higher is recommended. Control of Fraction Collector Frac-950 can be achieved automatically from a method, or manually via the functions available in UNICORN.

Using Fraction Collector Frac-950 in a method is described in the *ÄKTA design Optional Configuration User Manual*.

The following functions are available for operating Fraction Collector Frac-950 from UNICORN:

Manual	Method
Man_Fractionation	Fractionation
Fractionation_Stop	Fractionation_Stop
Feed_Tube	Feed_Tube
Man_Peak_Fractionation	Peak_Fractionation
Peak_Frac_Stop	Peak_Frac_Stop
AccumulatorWash	AccumulatorWash
Ignore_LastTube	-
Reset_Frac_Position	Reset_Frac_Position
(PeakFrac Parameters	(PeakFrac Parameters)



No.	Description	No.	Description
1	Select rack types	3	Select tube type and size
2	Select fractionation order	4	Select tube type and size

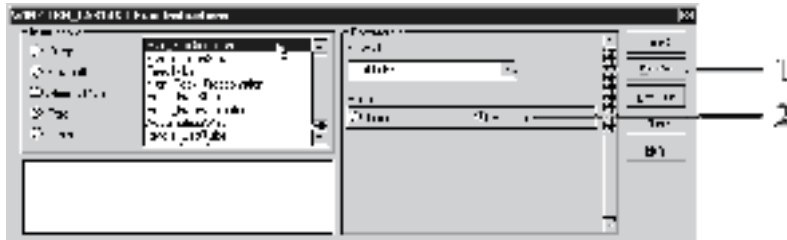

No.	Description	No.	Description
1	Select starting tubes	2	Select fractionation bases

It is also possible to set the delay volume, i.e., the added volume of tubing and components between the UV flow cell in the ÄKTA system and Fraction Collector Frac-950. This value must be changed when the ÄKTA standard configuration system is changed to an optional configuration.

Collecting fixed fractions

Details about collecting fixed fraction volumes using UNICORN in a method are described in the *ÄKTA design Optional Configuration User Manual*.

Collecting peak fractions

Details about collecting peaks only using Fraction Collector Frac-950 in a method are described in the *ÄKTA design Optional Configuration User Manual*.

Feed tube

During fractionation, the tube rack can be moved forward one tube with the instruction `FeedTube`.

- 1 Select menu **System Control:Manual:Frac** in UNICORN.
- 2 Select the instruction **FeedTube** in the Frac list.

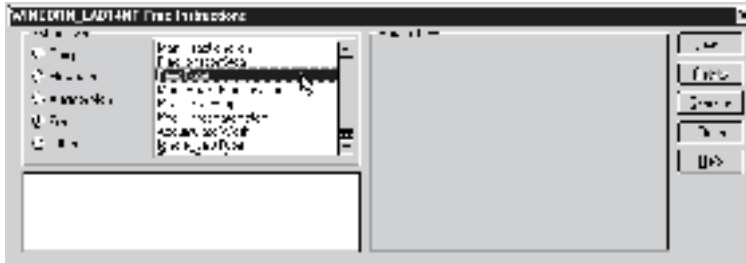

- 3 Click on the **Execute** button. The tube rack moves on to the next tube after the set delay volume has been collected.

Ignore_LastTube

The tube position in the rack which is defined in the start protocol to have the last tube can be ignored with the instruction `Ignore_LastTube`.

When the last tube is reached and there are more fractions to collect, an alarm is generated and the system is paused. You can then fill up with new tubes, and use the instruction `Ignore_LastTube`.

- 1 Select menu **System Control:Manual:Frac** in UNICORN.
- 2 Select the instruction **Ignore_LastTube** in the Frac list.

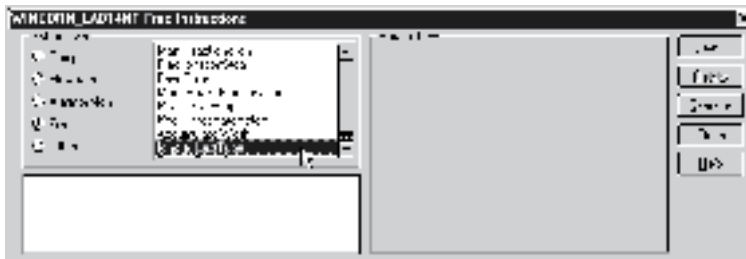

- 3 Click on the **Execute** button.
- 4 Fill up the rack with new tubes.

- 5 Click on the **Continue** button to restart the fractionation in the next tube.
-

Reset_Frac_Position

The instruction **Reset_Frac_Position** resets the fraction collector. This means that fractionation set to start at next position will start in the first position. The instruction will reset next position for all tube types.

- 1 Select menu **System Control:Manual:Frac** in UNICORN.
- 2 Select the instruction **Reset_Frac_Position** in the Frac list.

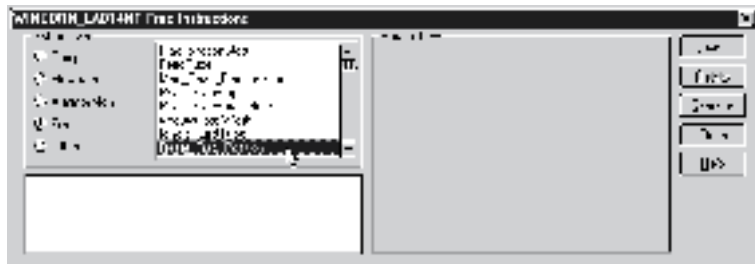

- 3 Click on the **Execute** button.
-

AccumulatorWash

The accumulator used to eliminate spillage at tube change can be manually washed with the instruction **AccumulatorWash**.

- 1 Start a flow of 10 ml/min manually using the system pump.
- 2 If the fraction collector is connected to any other port than port 1 in the Outlet valve, you must manually switch Outlet Valve to the other port. Select menu **System Control:Manual:Flowpath** in UNICORN.
- 3 Select the instruction **OutletValve** and select the desired port.
- 4 Click on the **Execute** button.
- 5 Select menu **System Control:Manual:Frac** in UNICORN.

4 Operation

4.3 Fraction Collector Frac-950

- 6 Select the instruction **AccumulatorWash** in the Frac list.

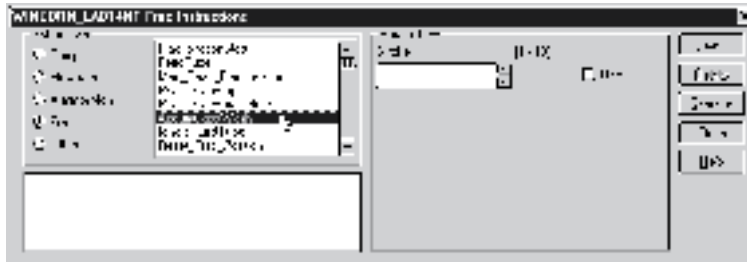

- 7 Select the number of strokes to be used for washing with the parameter **Strokes**.
- 8 Click on the **Execute** button.

Setting delay volume

The delay volume between the UV flow cell in the chromatographic system and Fraction Collector Frac-950 must be known to UNICORN. The delay volume is used to adapt the collected fractions to the event marks generated by UNICORN.

- 1 In UNICORN, select menu **System Control: System: Settings**
- 2 Click the **Specials** radio button and select instruction **FracParameters**. The **DelayVol** instruction becomes highlighted.
- 3 To change the setting, click on the up and down arrows for the **DelayVol** parameter, or type a new value directly in the parameter window.



- 4 The appropriate value for your ÄKTA system is found in the *ÄKTA design Optional Configuration User Manual*.
- 5 Click on the **OK** button. The value entered will be used until a further change is made.

Flow control during tube change

The liquid flow during tube change can be handled in three different ways.

- 1 In UNICORN, select menu **System Control:System:Settings**.
- 2 Click the **Specials** radio button and select instruction **FracParameters**. Highlight the **TubeChange** instruction.



- 3 For the parameter **TubeChange**, select one of the following options:
 - **Tube**
No synchronization of collection. Spillage will occur between tubes.
 - **DropSync**
Tube change is synchronized to drop release to minimize spillage.
Use i.d. 0.75 mm tubing between the DropSync and the accumulator.
 - **Accumulator**
During tube change, the flow is diverted to the accumulator which stores the liquid. When the new tube is in position, the liquid is pressed out rapidly for collection.
- 4 Flow rate limit recommendations using **DropSync** without spillage are given in the table below. For higher flow rates the accumulator is recommended for spillage free fractionation. For the 30 mm rack and Prep mode racks the accumulator is recommended.

Rack type	Flow rate limit using dropSync [ml/min]
microplates	0 to 1.0
12 mm	0 to 1.5
18 and 30 mm	0 to 2.0

4 Operation

4.3 Fraction Collector Frac-950

- 5 After selection, click on the **OK** button.
-

Define rack and tube parameters

When running a method, the rack and tube parameters for the rack to be used must be set. This is described in detail in the *ÄKTA design Optional Configuration User Manual*.

5 Maintenance

5.1 General

Fraction Collector Frac-920 and Frac-950 require no periodic maintenance.

5.2 Cleaning



WARNING

When using hazardous chemical and biological agents, take all suitable protective measures, such as wearing protective glasses and gloves resistant to the substances used. Follow local and/or national regulations for safe operation and maintenance of Fraction Collector Frac-920 and Frac-950.

The fraction collector should be kept clean and spilled liquid should be wiped off before it dries. Remove dirt from the surface using a cloth and a mild cleaning agent.

The rack holder should be positioned over the centre.

The safety bar should be folded down when the fraction collector is not in use (Fraction Collector Frac-950 only).

When your ÄKTA system is cleaned, also clean the capillaries and the accumulator in Fraction Collector Frac-950 with distilled water.

The instrument should be wiped regularly with a damp cloth. Remember to wipe the DropSync unit photocell as well. Allow the instrument to dry completely before use.

Cleaning before planned maintenance/service

To ensure the protection and safety of service personnel, all equipment and work areas must be clean and free of any hazardous contaminants before a Service Engineer starts maintenance work.

Please complete the checklist in the *On Site Service Health and Safety Declaration Form* or the *Health and Safety Declaration Form for Product Return or Servicing*, depending on whether the instrument is going to be serviced on site or returned for service, respectively.

Copy the form you need from [Section 7.2 Health and Safety Declaration Form, on page 52](#) or print it from the PDF file available on the User Documentation CD.

5 Maintenance

5.3 Changing capillaries

5.3 Changing capillaries

Change the capillaries when they show signs of leakage or wear (sharp bending, for example).

5.4 Changing waste tubing

Change the waste tubing when it shows signs of wear.

6 Troubleshooting



WARNING

Disconnect power. Always disconnect power from the instrument before performing any maintenance task.



WARNING

Do not open the instrument. There are no user serviceable components inside, and you can be exposed to high voltage.



CAUTION

Be sure to fold down the safety bar whenever the rack holder is operated by hand. This blocks the rack holder from accidentally moving while the rack is moved by hand or replaced. (Fraction Collector Frac-950 only)



CAUTION

Only spare parts that are approved or supplied by GE Healthcare may be used for maintaining or servicing the unit.

6.1 Faults and actions

Fault	Action
No tube change	<ul style="list-style-type: none"> Start a flow and start fractionation. Select FeedTube from the menu SystemControl:Manual:Flowpath. If the motor does not start and an error appears, contact GE Healthcare. Check the delay volume. A large delay volume at a low flow rate generates a long delay time.
Tubes skipped	Faulty parameters in UNICORN may be the cause.

6 Troubleshooting

6.1 Faults and actions

Fault	Action
DropSync is not functioning	<ul style="list-style-type: none">• The drop sensor photocell is dirty. Clean the photocell with a damp cloth.• Check that the capillary end projection is not too long (~2 mm).• Check that the flow rate is not too high (a continuous flow).
No fractions are collected	Check that the safety bar is folded up.
Liquid misses the tubes	<ul style="list-style-type: none">• Check that the DropSync unit is close enough over the tubes.• Check that the rack is correctly fitted to the rack holder.• Check that the capillary end is cut cleanly and straight.• Check that the correct rack type is selected.

7 Reference information

About this chapter

This chapter contains technical data, regulatory and other information.

7.1 Specifications

Parameter	Value
Ingression protection	IP21 (Frac-950) IP22 (Frac-920)
Supply voltage	100-240 V AC \pm 10%, 50 to 60 Hz
Power consumption	300 VA (Frac-950) 20 VA (Frac-920)
Dimensions (H x W x D)	480 x 380 x 550 mm (Frac-950) 250 x 320 x 400 mm (Frac-920)
Weight	16.5 kg (Frac-950) 4.5 kg (Frac-920)
Ambient temperature	4° to 40°C
Relative humidity tolerance	20% to 95% (non-condensing)
Atmospheric pressure	84 to 106 kPa (840 to 1060 mbar)
Acoustic noise level	73 dB A

7.2 Health and Safety Declaration Form

On site service



On Site Service Health & Safety Declaration Form

Service Ticket #:	
--------------------------	--

To make the mutual protection and safety of GE service personnel and our customers, all equipment and work areas must be clean and free of any hazardous contaminants before a Service Engineer starts a repair. To avoid delays in the servicing of your equipment, please complete this checklist and present it to the Service Engineer upon arrival. Equipment and/or work areas not sufficiently cleaned, accessible and safe for an engineer may lead to delays in servicing the equipment and could be subject to additional charges.

Yes	No	Please review the actions below and answer "Yes" or "No". Provide explanation for any "No" answers in box below.
<input type="radio"/>	<input type="radio"/>	Instrument has been cleaned of hazardous substances. Please rinse tubing or piping, wipe down scanner surfaces, or otherwise ensure removal of any dangerous residue. Ensure the area around the instrument is clean. If radioactivity has been used, please perform a wipe test or other suitable survey.
<input type="radio"/>	<input type="radio"/>	Adequate space and clearance is provided to allow safe access for instrument service, repair or installation. In some cases this may require customer to move equipment from normal operating location prior to GE arrival.
<input type="radio"/>	<input type="radio"/>	Consumables, such as columns or gels, have been removed or isolated from the instrument and from any area that may impede access to the instrument.
<input type="radio"/>	<input type="radio"/>	All buffer / waste vessels are labeled. Excess containers have been removed from the area to provide access.
Provide explanation for any "No" answers here:		
Equipment type / Product No:		Serial No:
I hereby confirm that the equipment specified above has been cleaned to remove any hazardous substances and that the area has been made safe and accessible.		
Name:		Company or institution:
Position or job title:		Date (YYYY/MM/DD):
Signed:		

GE and GE monogram are trademarks of General Electric Company.
 GE Healthcare Bio-Sciences Corp, 800 Centennial Avenue, P.O. Box 1327, Piscataway, NJ 08855-1327
 © 2010-14 General Electric Company—All rights reserved. First published April 2010.

DOC1149542/28-9800-26 AC 05/2014

Product return or servicing



Health & Safety Declaration Form for Product Return or Servicing

Return authorization number:		and/or Service Ticket/Request:	
------------------------------	--	--------------------------------	--

To make sure the mutual protection and safety of GE personnel, our customers, transportation personnel and our environment, all equipment must be clean and free of any hazardous contaminants before shipping to GE. To avoid delays in the processing of your equipment, please complete this checklist and include it with your return.

1. Please note that items will NOT be accepted for servicing or return without this form
2. Equipment which is not sufficiently cleaned prior to return to GE may lead to delays in servicing the equipment and could be subject to additional charges
3. Visible contamination will be assumed hazardous and additional cleaning and decontamination charges will be applied

Yes	No	Please specify if the equipment has been in contact with any of the following:
<input type="radio"/>	<input type="radio"/>	Radioactivity (please specify) _____
<input type="radio"/>	<input type="radio"/>	Infectious or hazardous biological substances (please specify) _____
<input type="radio"/>	<input type="radio"/>	Other Hazardous Chemicals (please specify) _____

Equipment must be decontaminated prior to service / return. Please provide a telephone number where GE can contact you for additional information concerning the system / equipment.

Telephone No:			
Liquid and/or gas in equipment is:	<input type="checkbox"/>	Water	
	<input type="checkbox"/>	Ethanol	
	<input type="checkbox"/>	None, empty	
	<input type="checkbox"/>	Argon, Helium, Nitrogen	
	<input type="checkbox"/>	Liquid Nitrogen	
	<input type="checkbox"/>	Other, please specify	
Equipment type / Product No:		Serial No:	

I hereby confirm that the equipment specified above has been cleaned to remove any hazardous substances and that the area has been made safe and accessible.

Name:		Company or institution:	
Position or job title:		Date (YYY/MM/DD)	
Signed:			

To receive a return authorization number or service number, please call local technical support or customer service.

GE and GE monogram are trademarks of General Electric Company.
GE Healthcare Bio-Sciences Corp, 800 Centennial Avenue, P.O. Box 1327, Piscataway, NJ 08855-1327, US

© 2010-14 General Electric Company—All rights reserved. First published April 2010.

DOC1149544/28-9800-27 AC 05/2014

7 Reference information

7.3 Ordering information

7.3 Ordering information

For ordering information visit www.gelifesciences.com/AKTA.

For local office contact information, visit
www.gelifesciences.com/contact

GE Healthcare Bio-Sciences AB
Björkgatan 30
751 84 Uppsala
Sweden

www.gelifesciences.com/AKTA

GE and GE monogram are trademarks of General Electric Company.

ÅKTA and UNICORN are trademarks of General Electric Company or one of its subsidiaries.

Microsoft and Windows are registered trademarks of Microsoft Corporation.

All other trademarks are the property of their respective owners.

Any use of UNICORN is subject to GE Healthcare Standard Software End-User License Agreement for Life Sciences Software Products. A copy of this Standard Software End-User License Agreement is available on request.

UNICORN © 2003-2015 General Electric Company.

© 2009-2015 General Electric Company - All rights reserved.

First published Jul. 2009

All goods and services are sold subject to the terms and conditions of sale of the company within GE Healthcare which supplies them. A copy of these terms and conditions is available on request. Contact your local GE Healthcare representative for the most current information.

GE Healthcare Europe GmbH
Munzinger Strasse 5, D-79111 Freiburg, Germany

GE Healthcare UK Limited
Amersham Place, Little Chalfont, Buckinghamshire, HP7 9NA, UK

GE Healthcare Bio-Sciences Corp.
800 Centennial Avenue, P.O. Box 1327, Piscataway, NJ 08855-1327, USA

GE Healthcare Japan Corporation
Sanken Bldg. 3-25-1, Hyakunincho Shinjuku-ku, Tokyo 169-0073, Japan

